

1967  
2023

MADE IN ITALY



Salone  
del Mobile.  
Milano

Saremo presenti a/we will be present  
Padiglione 11 - Stand 142

**EuroLuce.**

18 - 23. 04. 2023

 Italiano

 English

# Indoor Catalogue 2023

Informazioni  
**IMPORTANTI**  
Very important  
**INFORMATION**

Condizioni  
generali di vendita  
General sales  
conditions

## Sommario - Summary



<p>MyWay Bluetooth Pag.228 CASAMBI Pag.234</p>	<p><b>Syros R-C</b> recessed, ceiling, suspended Pag. 236</p>	<p><b>Patmos Lens R-C</b> recessed, ceiling, suspended Pag. 243</p>	<p><b>Egeo R-C</b> recessed, ceiling, suspended Pag. 247</p>
--	---	---	--

<p><b>Zante</b> recessed, ceiling, suspended Pag. 250</p>	<p><b>Milo backlit</b> recessed, ceiling Pag. 257</p>	<p><b>Milo backlit IP65</b> recessed, ceiling Pag. 257</p>	<p><b>Itaca R-C</b> recessed, ceiling, suspended Pag. 260-265</p>
---	---	--	---

<p><b>Itaca doghe speciali</b> recessed, ceiling Pag. 266</p>	<p><b>Mercedes S-C-Floor</b> ceiling, suspended, floor Pag. 268</p>	<p><b>Mercedes Floor up &amp; down</b> floor Pag. 276</p>	<p><b>Zante Floor up &amp; down</b> floor Pag. 278</p>
---	---	---	--

## Sommario - Summary

<p><b>Giorgia</b> floor Pag. 280</p>	<p><b>Unica S-C</b> ceiling, suspended Pag. 282</p>	<p><b>Syros Slim S-C</b> ceiling, suspended Pag. 284</p>	<p><b>Sky system S-C</b> ceiling, suspended Pag. 293</p>
--	---	--	--

<p><b>IP20 IK06 IP44 IK06</b> <b>Ferma</b> recessed Pag. 308</p>	<p><b>IP44</b> <b>Cielo QR</b> recessed Pag. 310</p>	<p><b>IP44</b> <b>Cielo RR - Cielo 3RR</b> recessed Pag. 312-313</p>	<p><b>IP65</b> <b>Beautylight</b> recessed Pag. 314</p>
--	--	--	---

<p><b>IP44</b> <b>Gloria RR</b> recessed Pag. 316</p>	<p><b>IP44</b> <b>Gloria QR</b> recessed Pag. 318</p>	<p><b>Gessi incasso</b> recessed Pag. 321-324</p>	<p><b>NEW</b> <b>Imperceptible</b> recessed Pag. 325-328</p>
---	---	---	--

<p><b>IP54</b> <b>Life 150</b> recessed Pag. 329-331</p>	<p><b>IP54</b> <b>Life</b> recessed Pag. 332-334</p>	<p><b>Marian</b> recessed Pag. 335</p>	<p><b>IP20 IK06 IP44 IK06</b> <b>Ardito</b> recessed Pag. 336</p>
--	--	--	---

## Sommario - Summary

<p><b>BASIC series IP44 IK06</b> <b>3in1</b> <b>Otto</b> recessed Pag. 338</p>	<p><b>BASIC series IP44 IK06</b> <b>NEW 6in1</b> <b>Nove</b> recessed Pag. 340</p>	<p><b>Bazar</b> recessed Pag. 342</p>	<p><b>Horo</b> recessed Pag. 344</p>
--	--	---	--

<p><b>Trim R Opal</b> recessed Pag. 346</p>	<p><b>Trim 50 R Opal</b> recessed Pag. 348</p>	<p><b>Syros Slim system R</b> recessed Pag. 350</p>	<p><b>LEDresswall</b> recessed Pag. 354</p>
---	--	---	---

<p><b>Equal Serie</b> recessed, ceiling, wall, Pag. 358-363</p>	<p><b>IP44</b> <b>Camilla - Dolcetondo</b> ceiling Pag. 364</p>	<p><b>IP44</b> <b>Dolcetondo</b> ceiling Pag. 366</p>	<p><b>Quadro Trifase</b> track light Pag. 368</p>
---	---	---	---

<p><b>Primadonna trifase</b> Track light Pag. 372</p>	<p><b>NEW</b> <b>Regina 3 CCT trifase</b> Track light Pag. 375</p>	<p><b>Primavera trifase</b> track light Pag. 380</p>	<p><b>Shop windows Trifase</b> track light Pag. 382</p>
---	--	--	---

Informazioni  
**IMPORTANTI**  
Very important  
**INFORMATION**

Condizioni  
generali di vendita  
General sales  
conditions

## Sommario - Summary



**Sirio-Venere-Cuculo**  
Track light  
Pag. 384



**Syros Slim system trifase**  
Track light  
Pag. 386



**3S Sky system trifase**  
Track light  
Pag. 388

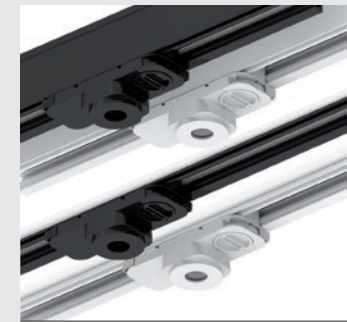

**3 circuit Track light**  
ceiling, suspended, recessed  
Pag. 392



**Audace C-W-R**  
ceiling, wall, recessed  
Pag. 396



**Primavera C-W-R**  
ceiling, wall, recessed  
Pag. 398



**Primadonna C-W**  
ceiling, wall  
Pag. 400



**LED Pop W - WD - LED Pop F**  
wall, floor  
Pag. 402-405



**Gessi applique**  
wall  
Pag. 406



**Huitre**  
wall  
Pag. 408



**Rouget**  
wall  
Pag. 409



**Primadonna S**  
suspended  
Pag. 410



**Belladigiorno**  
suspended  
Pag. 412



**Zante Top up & down**  
suspended  
Pag. 414



**Luxxi**  
suspended  
Pag. 416



**LED Estensione - cable light**  
suspended , ceiling , wall  
Pag. 418-423

## Sommario - Summary



**Strisce Flex - Drivers 12/24V**  
and accessories  
Pag. 424-437



**LED Classica**  
ceiling  
Pag. 438



**Control panel / Router Dali**  
Emergency LED system  
Pag. 444



**Osiride Dali**  
Emergency LED system  
Pag. 446



**Osiride Segnalazione Dali**  
Emergency LED system  
Pag. 450



**LED SPOT EMER SE 3H Dali**  
Emergency LED system  
Pag. 452



**Venere MyWay**  
Emergency LED system  
Pag. 456



**Raja W-C-R**  
Emergency LED system  
Pag. 458



**Orione**  
Emergency LED  
Pag. 460



**Sirio - Venere**  
Emergency LED system  
Pag. 464 > 471



**LED SPOT EMER SE 3H**  
flush mounting Box503  
Pag. 472



**Cuculo 503**  
recessed, wall  
Pag. 474



**LED Keymer**  
flush mounting Box503  
Pag. 476



**Lampade medicali**  
Pag. 478



**Dado**  
Depuratore antivirale e  
antibatterico Pag. 483



**SPECIAL OFFER**  
Fino ad esaurimento scorte  
Untill stock last Pag. 489-512



# MyWay Bluetooth<sup>®</sup> 5.0 SIG MESH

## Guida al sistema di gestione della luce *Light management system guide*

- **non necessita di sistemisti e di costi aggiuntivi di programmazione**  
*it does not require system engineers and additional programming costs*
- **permette attraverso la gestione intelligente della luce un risparmio del **70%****  
*intelligent light management enables a saving of*
- **azzerare la manutenzione con comunicazione costante via mail dello stato dell'impianto**  
*eliminates maintenance with constant communication of the system status via email*

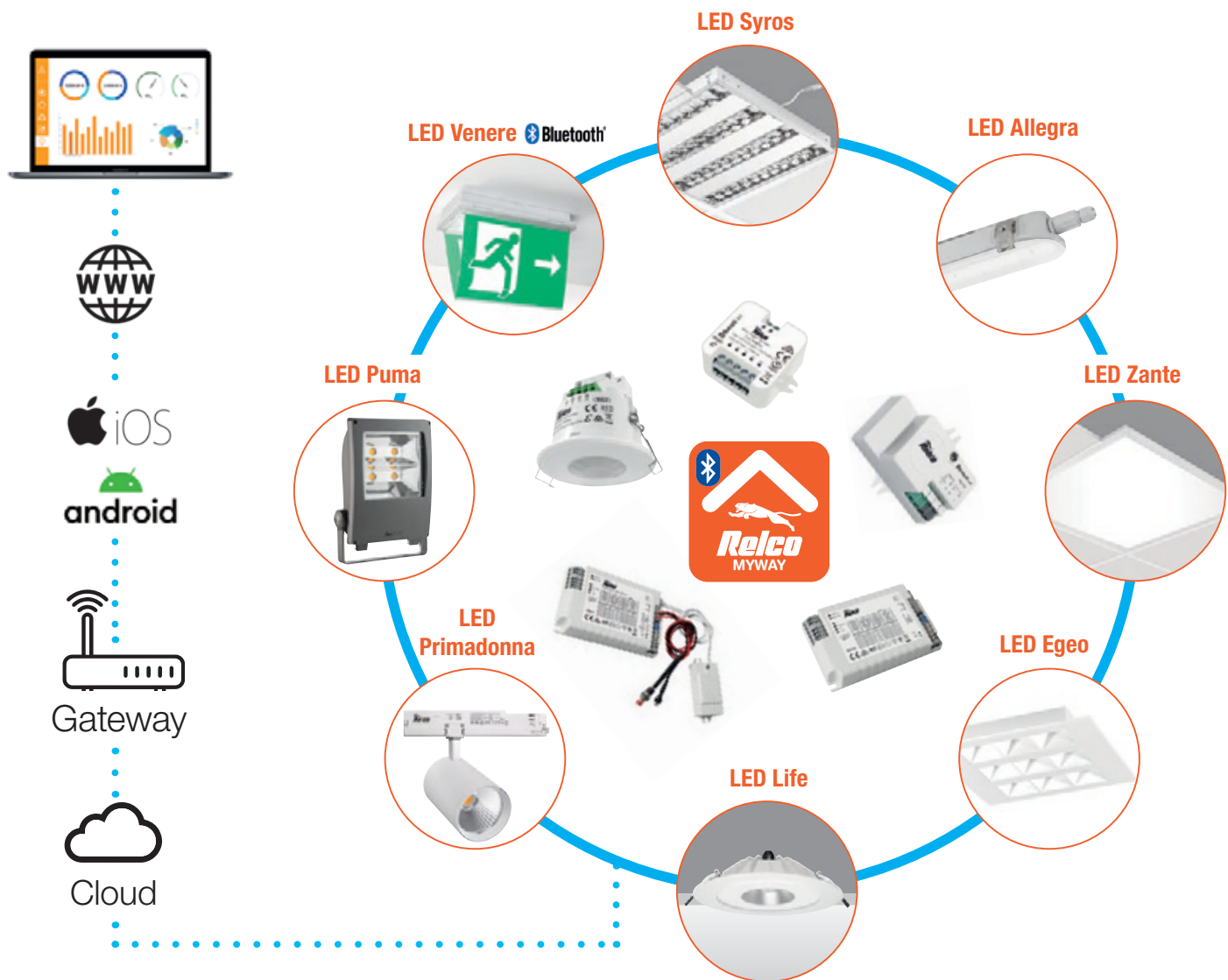

**Varialuce  
Dimmer**



**DIMBTDA**

**Sensore con Varialuce  
Sensor with dimmer**



**HBTDA**

**Rilevatore di movimento ON-OFF  
ON-OFF motion detector**



**BC360A-D02/BT**

**Alimentatore  
Driver**



**RN9168/BT**

## App proprietaria - Proprietary app



Bluetooth® 5.0 SIG MESH



Sensore di movimento con Varialuce integrato  
*Motion sensor with integrated dimmer*



Sensore di movimento con Varialuce integrato  
*Motion sensor with integrated dimmer*



ON-OFF Dimmer 0-10V/DALI 2



LED Driver settabile - *Settable LED Driver*



Rilevatore di movimento ON-OFF a microonde  
*Microwave ON-OFF motion detector*



LED Emergency Kit SA-SE



Pulsante - *Push-button*



EnOcean

Gateway



Adattatore da binario con led driver  
*Track adapter with led driver*





## App proprietaria da scaricare gratuitamente:

- Configurazione rapida.
- Gestione della luce, degli scenari ON-OFF, dimmerazione, Timer astronomico, Ritmo circadiano.
- Programmazione dei singoli apparecchi **Bluetooth 5.0 SIG MESH**
- Password di sistema e diversi livelli di autorizzazione.
- Schedulazione di ogni programmazione con salvataggio in Cloud.
- Richiamo degli scenari e dimmerazione tramite qualsiasi pulsante normalmente aperto.

## Proprietary app to download for free:

- Quick configuration.
- Management of light, ON-OFF scenarios, dimming, astrological timer, circadian rhythm.
- Programming on individual devices **Bluetooth 5.0 SIG MESH**
- System password and different authorisation levels.
- Scheduling of each programming with Cloud storage.
- Recalling of the scenarios and dimming via any normally open button.



## Sensore di movimento e crepuscolare con Varialuce integrato:

- è il **software**, è l'**hardware** del sistema integrato nell'apparecchio.
- Funzione MASTER e SLAVE.
- Dimmer **DALI** in **Bluetooth 5.0 SIG MESH** funzione ON-OFF, temporizzazione.
- Applicazione ad incasso o plafone.

## Motion and twilight sensor with integrated Dimmer:

- it is the **software**, the **hardware** of the system integrated into the device.
- MASTER and SLAVE function.
- Dimmer **DALI** in **Bluetooth 5.0 SIG MESH** function, timing.
- Recessed or ceiling-mounted application.



cod. **HBTDA**  
Informazioni prodotto  
Product information



cod. **HBTDAP**  
Accessorio per montaggio a plafone  
Ceiling mount accessory

	Lenti incluse nella confezione <i>Lenses included in the package</i>	Rilevamento max (DxH) Max detection (DxH)	Asimmetrica <i>Asymmetric</i>	Per corridoi for corridors
Convessa <i>Convex</i>		10m x 3m		
Piatta <i>Flax</i>		9m x 3m		

### Schema di collegamento - Wiring diagram

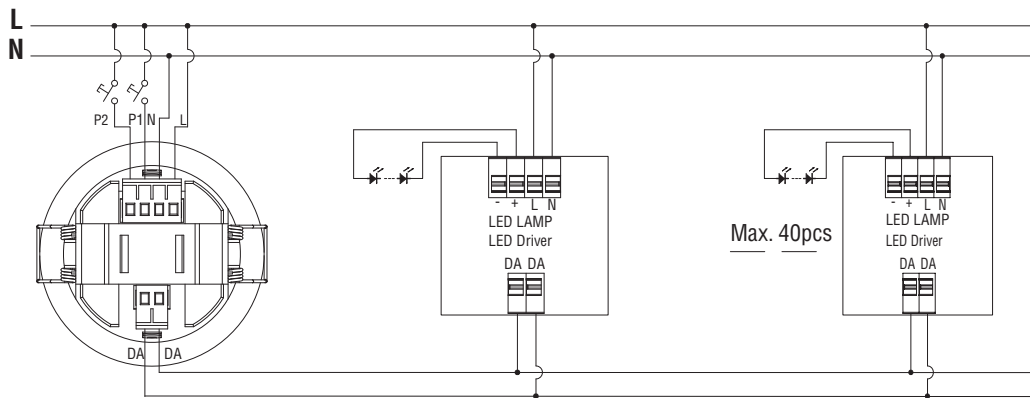

- Max 40 apparecchi  
Max 40 devices
- Max 35m

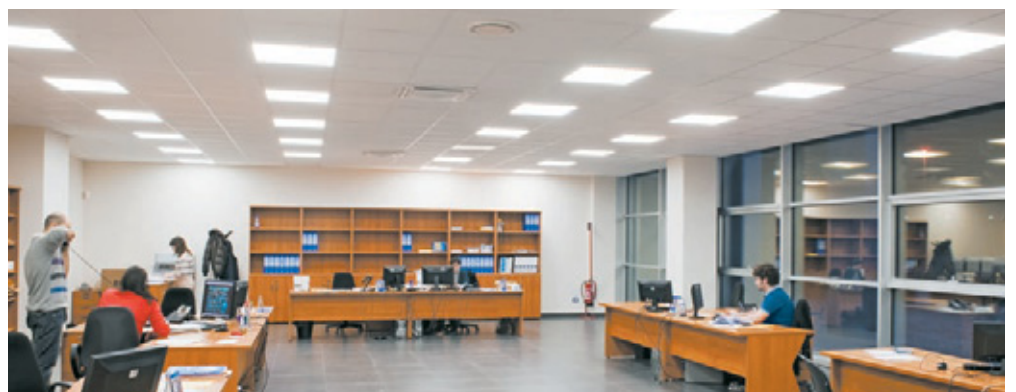



Code: **DIMBTDA** **DALI**



Informazioni prodotto  
Product information

- Max 40 apparecchi (DALI)  
Max 40 devices (DALI)

- Max 35m

### Dimmer **DALI**:

- Dimmer 0-10V in **Bluetooth** 5.0 SIG MESH funzione ON-OFF, dimmerazione e temporizzazione.
- Dimmer **DALI** in **Bluetooth** 5.0 SIG MESH funzione ON-OFF, dimmerazione e temporizzazione.
- Funzione MASTER e SLAVE.
- Installazione in scatola 503, a bordo lampada e... ..dove ritenete necessario.

### Dimmer **DALI**:

- Dimmer 0-10V in **Bluetooth** 5.0 SIG MESH ON-OFF function, dimming and timing.
- Dimmer **DALI** in **Bluetooth** 5.0 SIG MESH function, dimming and timing.
- MASTER and SLAVE function.
- Application in recessed box 503, in the lamp or...where necessary.

#### Schema di collegamento - Wiring diagram

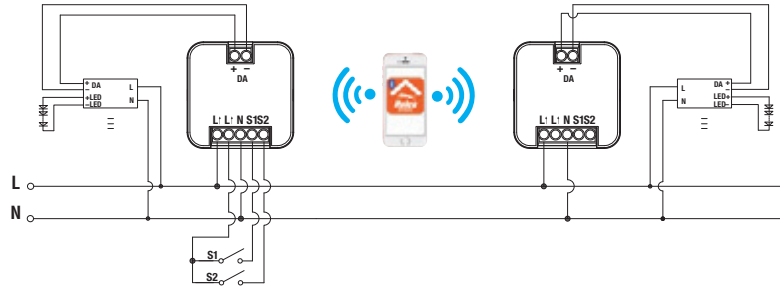

Code: **DIMBTDIM** **0-10V**



Informazioni prodotto  
Product information

- Max 10 apparecchi (0-10V)  
Max 10 devices (0-10V)

- Max 35m

### Dimmer **0-10V**:

- Dimmer 0-10V in **Bluetooth** 5.0 SIG MESH funzione ON-OFF, dimmerazione e temporizzazione.
- Portata contatto relè 0-10V. max 400W
- Funzione MASTER e SLAVE.
- Installazione in scatola 503, a bordo lampada e... ..dove ritenete necessario.

### Dimmer **0-10V**:

- Dimmer 0-10V in **Bluetooth** 5.0 SIG MESH ON-OFF function, dimming and timing.
- Maximun capacity contact relay 0-10V. 400W.
- MASTER and SLAVE function.
- Application in recessed box 503, in the lamp or...where necessary.

#### Schema di collegamento - Wiring diagram

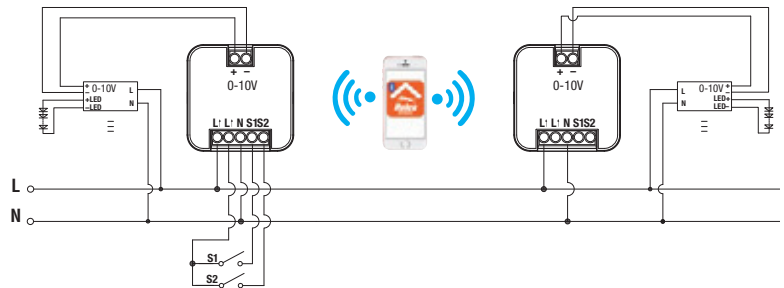

Code **RN9168/BT**



Informazioni prodotto  
Product information



### Led Driver settabile:

- Alimentatore multipotenza **Bluetooth** 5.0 SIG MESH fornito di dip-switch per la selezione della corrente in uscita
- è il software, è l'hardware del sistema integrato nell'apparecchio.
- Funzione MASTER e SLAVE.
- Funzione on off -Dimmer e White Tunable.

### Settable LED Driver:

- Multi-power Driver **Bluetooth** 5.0 SIG MESH equipped with dip-switch to select the output current
- it is the software, the hardware of the system integrated into the device.
- MASTER and SLAVE function.
- On off -Dimmer and White Tunable function.

Iout	mA	400	500	600	700	800	900	1000
Vout	Vdc	45	45	45	45	45	45	45
Power	W	16	20	25	30	35 (30)	40 (30)	45 (30)
N° LED typical VF 3,2V	min-max	1÷14	1÷14	1÷14	1÷14	1÷14	1÷14	1÷14
<b>COB - Typical VF 37V</b>								



Code **BC360A-D02/BT**



Informazioni prodotto  
Product information

**Schema elettrico di rilevamento**  
*Detection diagram*

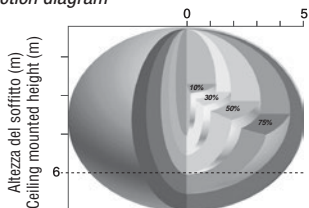

Schema di rilevamento montato a soffitto (m)  
Ceiling mounted detection diagram (m)

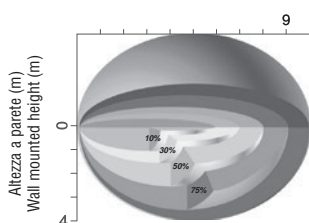

Schema di rilevamento montato a parete (m)  
Wall mounted detection diagram (m)

## Rilevatore di MOVIMENTO ON-OFF a microonde con crepuscolare

**Bluetooth®5.0 SIG MESH** per impostazione soglia Lux ambiente di intervento, questa tecnologia consente di "nascondere" il rilevatore anche all'interno di corpi lampada infatti esso emette onde elettromagnetiche ad alta frequenza (5,8GHz) e riceve la loro propagazione, in questo modo è in grado di riconoscere una qualsiasi variazione data da un oggetto non rilevato nella precedente analisi e verrà dato il comando di ON.

- Trasmissione ad alta frequenza <10mW e risulta essere 100 volte inferiore alle emissioni di un comune telefono cellulare o di un forno a microonde che emettono mediamente 1000mW.

## ON-OFF microwave motion sensor with twilight sensor

**Bluetooth®5.0 SIG MESH** for setting the Lux level of the work environment, this technology enables to "hide" the detector even inside the fixture. In fact, it emits high frequency electromagnetic waves (5.8GHz) and receives their echo, thus being able to recognise any variation given by an object not detected in the previous analysis and the ON command will be issued.

- High frequency transmission <10mW and 100 times lower than the emissions of a common mobile phone or microwave oven which emit 1000mW on average.

**Schema di collegamento**  
*Wiring diagram*

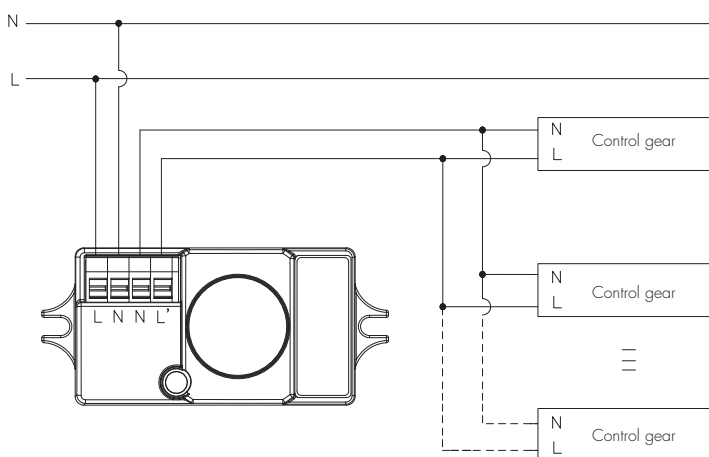

## Emergenza LED Kit SA-SE

Sistema di emergenza **Bluetooth®5.0 SIG MESH**

**3W - 1h/17% 180÷250 Vac**, che permette il funzionamento di apparecchi di illuminazione con led di potenza o faretto LED anche quando viene a mancare l'energia elettrica. Il sistema si compone di un inverter elettronico con uscita a potenza costante e da una batteria integrata del tipo **LiFePO4**.

Sono possibili 2 modalità di funzionamento:

- SA: funzionamento permanente
- SE: funzionamento non permanente

## LED Emergency Kit SA-SE

Emergency system **Bluetooth®5.0 SIG MESH**

**3W - 1h/17% 180-250 Vac**, which enables the operation of lighting devices with power LEDs or LED spotlights even when in the absence of electricity.

The system consists of an electronic inverter with constant-power output and an integrated **LiFePO4** battery.

There are 2 potential operating modes:

- SA: permanent operation
- SE: non-permanent operation



**Q2 2021**



Code **DRVEM01/BT**  
Informazioni prodotto  
Product information

## Console di comando a pulsante ad induzione:

Sistema di comando **Bluetooth®5.0 SIG MESH** ad induzione.

**Sono possibili diversi scenari di funzionamento es:**

- ON-OFF
- Dimmerazione

## Induction pushbutton control console:

Induction control system **Bluetooth®5.0 SIG MESH**

**Various operating scenarios are possible, e.g.:**

- ON-OFF
- Dimming



Code **EWSDB**



Informazioni prodotto  
Product information





Code **GATEWAY01**

## Gateway

Il gateway GATEWAY01, offre un rapido e semplice accesso remoto alla rete mesh Bluetooth. Facilita la trasmissione dei dati tra rete mesh ed Ethernet cablata o wireless.

L'uso di GATEWAY01 consente la raccolta di dati IoT, l'accesso / monitoraggio remoto, la sincronizzazione della rete in tempo reale e anche la possibilità di una facile risoluzione dei problemi nelle applicazioni reali.

Gateway GATEWAY01 offers a quick and easy way of remote access to Bluetooth mesh network. It facilitates the data transmission between mesh network and Ethernet wired or wirelessly. The use of GATEWAY01 enables IoT data gathering, remote access/monitoring, network real-time synchronization, and also the possibility of easy trouble-shooting in real applications.

Dimensioni prodotto Product dimensions	105x105x25mm
CPU	Allwinne H6.up to 1,5Ghz
GPU	Mali-T720
RAM	4G DDR III
ROM	32G
DC In	DC5V/2A
Lan	RJ45 Ethernet port (100M)

Dual Wifi	2,4G + 5G (AC 2x2)
BT	BT4
Indicatore potenza Power indicator	Power On: Blue
Bluetooth range	Max 10m
Norme di riferimento Safety and EMC	EN-60950-1; EN-301489-17; EN-301489-1; EN-30328
Temperatura di esercizio Operation temperature	Ta: -35...70°C
Grado IP IP rating	IP20

**WORK**  
in progress



Code **HBTDAIP65**

**IP65**



## Sensore di movimento e crepuscolare con Varialuce integrato:

- è il **software**, è l'**hardware** del sistema integrato nell'apparecchio.
- Funzione MASTER e SLAVE.
- Dimmer **DALI** in **Bluetooth 5.0 SIG MESH** funzione ON-OFF, temporizzazione.
- Applicazione ad incasso o plafone.

## Motion and twilight sensor with integrated Dimmer:

- it is the **software**, the **hardware** of the system integrated into the device.
- MASTER and SLAVE function.
- Dimmer **DALI** in **Bluetooth 5.0 SIG MESH** function, timing.
- Recessed or ceiling-mounted application.

**WORK**  
in progress



Code **HBTDIMIP65**

**IP65**

**0-10V**

## Sensore di movimento e crepuscolare con Varialuce integrato:

- è il **software**, è l'**hardware** del sistema integrato nell'apparecchio.
- Funzione MASTER e SLAVE.
- Dimmer **0-10V** in **Bluetooth 5.0 SIG MESH** funzione ON-OFF, temporizzazione.
- Applicazione ad incasso o plafone.

## Motion and twilight sensor with integrated Dimmer:

- it is the **software**, the **hardware** of the system integrated into the device.
- MASTER and SLAVE function.
- Dimmer **0-10V** in **Bluetooth 5.0 SIG MESH** function, timing.
- Recessed or ceiling-mounted application.

Professionale CASAMBI  
Cod.R127630



**Norme di riferimento  
Standard Compliance**  
EN 55015  
EN 61000-3-2  
EN 61000-3-3  
EN 61347-1  
EN 61347-2-13  
EN 61547  
EN 62311  
EN 62386-251  
EN 62386-252  
EN 62386-253  
ETSI EN 300 328  
ETSI EN 301 489-1 ETSI  
EN 301 489-17



Codice Code	LPH ↓ 1mm	Vdc IN	DM	Vac IN	DM	Hz	50	IC	ta °C	tc °C	PFC	λ max. Power Factor
R127630	146,5 x 44 x 30	176÷275V	CASAMBI	220–240 V	CASAMBI PUSH	50/60	50	5A 50µs	-25...+45	85	OK	0,95

Iout	mA	300	350	400	450	500	550	600	650	700	750	800	850	900	950	1000	1050
Vout	Vdc	10÷54	10÷54	10÷54	10÷54	10÷54	10÷54	10÷54	10÷54	10÷51	10÷50	10÷47	10÷44	10÷42	10÷40	10÷38	10÷36
Power	W	16	18,5	21,5	24	27	29,5	32	35	36	38	38	38	38	38	38	38
n° led	min-max	3÷16	3÷16	3÷16	3÷16	3÷16	3÷16	3÷16	3÷16	3÷16	3÷15	3÷14	3÷13	3÷13	3÷12	3÷11	3÷11

### Caratteristiche:

- Alimentatore multipotenza fornito di dip-switch per la selezione della corrente in uscita con integrato ricevitore wireless CASAMBI.
- Alimentatore indipendente IP20, per uso interno.
- Protetto in classe II contro le scosse elettriche per contatti diretti e indiretti.
- PFC attivo.
- Corrente regolata ±5 % incluse variazioni di temperatura.
- Morsetti di entrata e uscita contrapposti (sezione cavo fino a 1,5 mm<sup>2</sup> / AWG15).
- Serracavo su primario e secondario per cavi di diametro: min. 2 mm - max. 9 mm.
- Fissaggio dell'alimentatore tramite asole per viti.
- Protezioni:
  - termica e cortocircuito;
  - contro le extra-tensioni di rete;
  - contro i sovraccarichi.
- Protezione termica = C.5.a.

### Features:

- Multipower driver supplied with dip-switch for the selection of the output current with integrated wireless CASAMBI receiver.
- IP20 independent driver, for indoor use.
- Class II protection against electric shock for direct or indirect contact.
- Active Power Factor Corrector.
- Current regulation ±5 % including temperature variations.
- Input and output terminal blocks on opposite sides (wire cross-section up to 1,5 mm<sup>2</sup> / AWG15).
- Clamping screws on primary and secondary circuits for cables with diameter: min. 2 mm - max. 9 mm.
- Driver can be secured with slot for screws.
- Protections:
  - against overheating and short circuits;
  - against mains voltage spikes;
  - against overloads.
- Thermal protecti

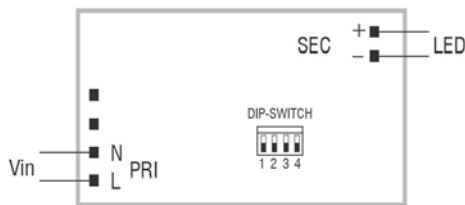

Collegamento Wireless CASAMBI  
CASAMBI Wireless diagram

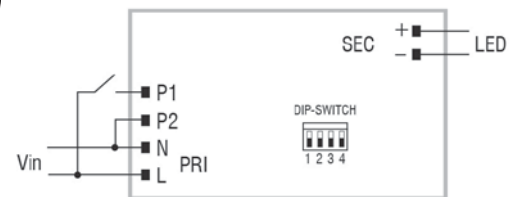

Collegamento PUSH SWITCH  
PUSH SWITCH diagram



### Caratteristiche:

- Regolazione della luminosità 0/1 - 100 % mediante funzione PUSH SWITCH e APP o dispositivi compatibili per modulo WIRELESS CASAMBI integrato.
- Regolazione solo AM: 1-100% (corrente minima: 7 mA).
- Regolazione della luminosità 0/1 - 100 % mediante la funzione PUSH SWITCH (tensione di rete):
  - una pressione breve per accendere e spegnere;
  - una pressione prolungata per aumentare o diminuire l'intensità luminosa;
  - la regolazione si ferma automaticamente ai valori minimi e massimi;
  - per un nuovo comando accensione, regolazione o spegnimento, rilasciare il pulsante e dare nuovamente il comando desiderato;
  - ripristino del livello di dimming al ritorno alimentazione.
- La lunghezza massima dei cavi, dal pulsante all'ultimo trasformatore, deve essere max. 15 m / 49 ft. In caso di applicazioni dove il cavo superi i 15 m / 49 ft, tenere lo stesso separato dal cavo di rete 110 - 240 Volt.
- ATTENZIONE: usare solo pulsanti di tipo normalmente aperto privi di spia luminosa incorporata.

### Features:

- Light regulation 0/1 - 100 % by means of PUSH SWITCH function and APP or compatible devices for CASAMBI integrated WIRELESS module.
- Full AM DIMMING: 1-100% (minimum current: 7 mA).
- Light regulation 0/1 - 100 % by means of PUSH SWITCH function (mains voltage):
  - a short push to turn on and off;
  - a longer push to increase or decrease light intensity;
  - regulation automatically stops at minimum and maximum values;
  - for another on, regulation or off command, release the push button and give the desired command again;
  - dimming level memory at mains restore.
- Maximum length of the cable, from push button to last driver, must be max. 15 m / 49 ft. In case of applications where the cable is longer than 15 m / 49 ft, keep this separate from the 240 V mains cable.
- ATTENTION: only use normally open push buttons with no incorporated warning light.

## Dali Casambi interface

Convertitore di segnale WIRELESS CASAMBI - DALI (DT6 - DT8)  
WIRELESS CASAMBI - DALI (DT6 - DT8) signal converter

DALI CASAMBI - INTERFACE  
Cod.R127659



0/1...10V

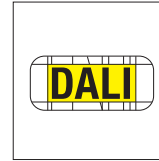

Norme di riferimento  
Standard Compliance

EN 55015  
EN 61000-3-2  
EN 61347-1  
EN 61347-2-11  
EN 61547  
EN62311  
ETSI EN 300 328  
ETSI EN 301 489-1  
ETSI EN 301 489-17



SELV 60V



Codice Code	LPH ↓↑mm	Vac IN	DM	Hz	ta °C	tc °C	λ max. Power Factor
R127659	135,20 x 30.2 x 21,5	100-240	CASAMBI DALI 1-10V	50/60	-25...+50	70	0,4 C



### Caratteristiche:

- Interfaccia in grado di convertire il segnale tipo **WIRELESS CASAMBI** in segnali DALI (fino a 4 canali indipendenti) e 1-10V (I=10mA).
- L'interfaccia alimenta il bus DALI fino a 40 dispositivi (fino a 64 con alimentatore DALI addizionale).
- Tramite APP CASAMBI è possibile configurare e controllare la rete DALI.
- Adatto per dispositivi DAL DT6 - DT8 (TW - RGB).
- Interfaccia indipendente IP20, per uso interno (DALI CASAMBI).
- Utilizzabile per apparecchi di illuminazione in classe di protezione I e II (DALI CASAMBI BI).
- Morsetti di entrata e uscita contrapposti:  
(sezione cavo fino a 0,5 - 1,5 mm / AWG 20 - AWG 15).
- **Protezioni:**
  - in ingresso contro sovratensioni impulsive di rete;
  - al corto circuito e al circuito aperto;
  - temperatura.
- Protezione termica = C.5.e.

### Features:

- Interface which can convert a **WIRELESS CASAMBI** signal into a DALI signal (up to 4 independent channels) and 1-10V (I=10mA).
- The interface supplies the DALI bus up to 40 devices (up to 64 with additional DALI supply).
- APP CASAMBI allows commissioning and control of the DALI network.
- Suitable for DALI DT6 - DT8 (TW - RGB devices).
- Independent IP20 interface, for indoor use (DALI CASAMBI).
- It can be used for lighting equipment in protection I and II (DALI CASAMBI BI).
- Input and output terminal blocks on opposite sides (wire-cross section up to 0,5 - 1,5 mm / AWG 20 - AWG 15).
- **Protections:**
  - against input overvoltages from main;
  - against short circuit and open circuit;
  - thermal.
- Thermal protection = C.5.e.



Gruppi Lampade  
Grouping



Scene  
Scenes



RGB

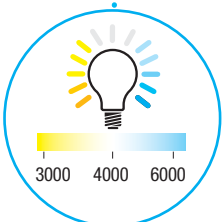

Temperatura colore °K  
Colour temperature



Calendarizzazione  
Scheduling

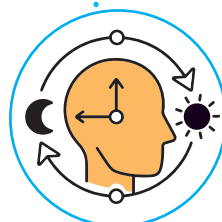

Ritmo circadiano  
Circadian rhythm



# LED Syros R-C

A RICHIESTA  
ON DEMAND

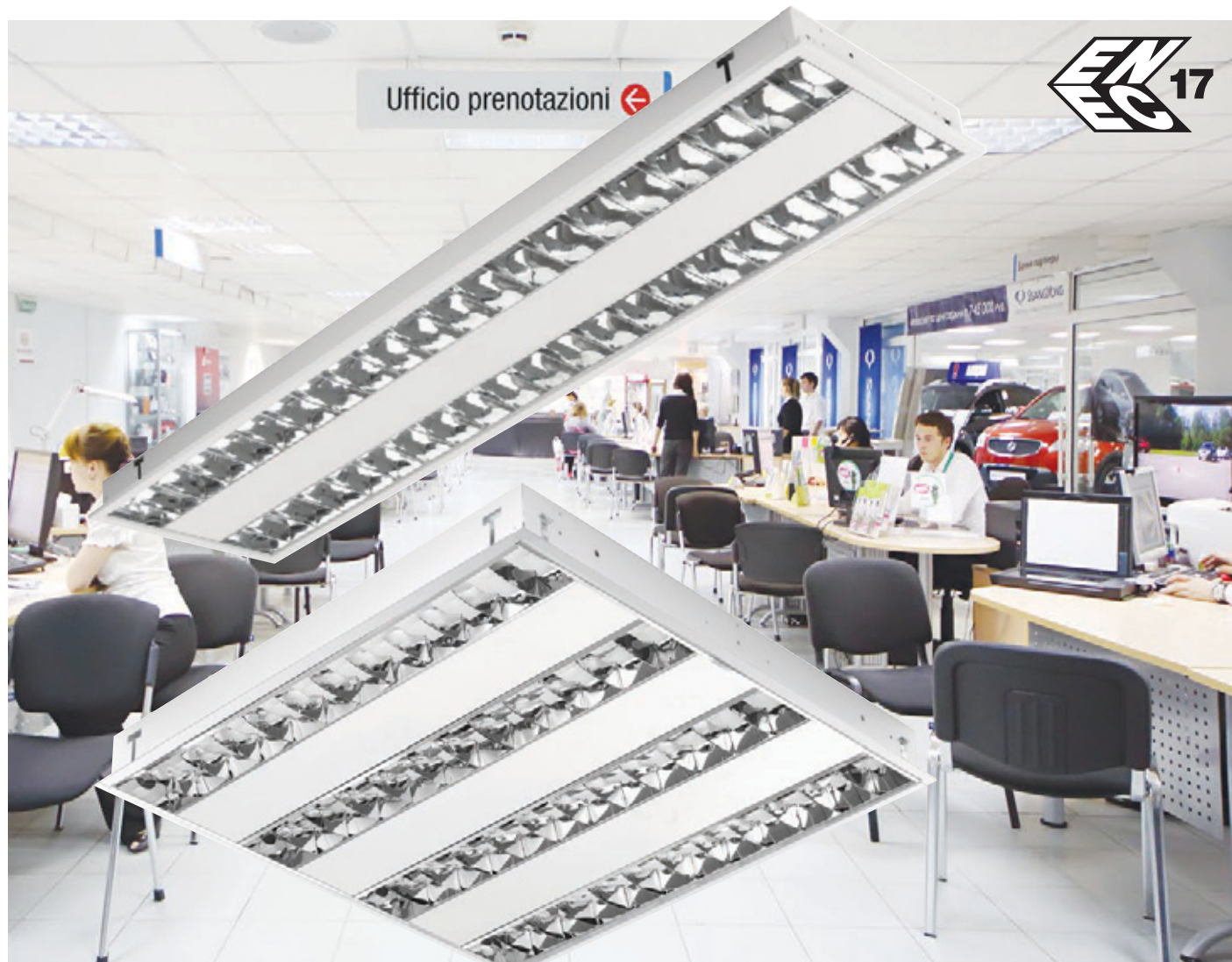

Serie di apparecchi a LED per utilizzo a plafone, per aree comuni, corridoi, scale, laboratori, strutture sanitarie, sale riunioni, negozi, ecc. Adatte per controsoffitti a vista, disponibili con grado IP20 oppure in IP65.

**Installazione:** ad incasso in appoggio sulla struttura a "T" del controsoffitto, ad incasso (R) in controsoffitti di cartongesso (con accessori di montaggio), a plafone (C), a sospensione (S) (con accessori di montaggio).

**Corpo:** lamiera d'acciaio galvanizzato e verniciato a forno con resina di poliestere bianca.

**Ottica:** parabola dark light in alluminio 99,85, speculare, antiriflesso e antiridescente a bassissima luminanza, schermo Policarbonato sagomato opalino a copertura dei vari circuiti LED. Per la versione IP65 schermo di protezione in vetro temperato trasparente.

**Conforme alla norma:** EN60598-1, RGO nessun rischio fotobiologico ai fini della norma EN62471.

**LED: SAMSUNG** mantenimento del flusso luminoso minimo al 80%: 50.000h (L80B10).

**Driver multipotenza:** Incluso > 50.000 h Fattore di potenza ≥0,95.

**Prodotto conforme alle direttive:**

Range of LED ceiling fixtures for communal areas, corridors, staircases, laboratories, meeting rooms, shops, etc. Suitable for exposed false ceilings, available with IP20 or IP65 protection degree.

**Installation:** recessed in support on the "T" structure of the false ceiling, recessed (R) in plasterboard false ceilings (with mounting accessories), surface-mounted (C), suspension (S) (with mounting accessories).

**Body:** steel sheeting galvanised and oven-painted with white polyester resin.

**Optics:** dark light parabola in aluminium 99.85, specular, antireflective and anti-iridescent at very low luminance, screen of shaped opaline polycarbonate to cover the different LED circuits. For the IP65 version, clear tempered glass protection screen.

**According to standard:** EN60598-1, RGO exempt from photo-biological risks in compliance with standard EN62471.

**LED: SAMSUNG** maintenance of minimum luminous flux to 80%: 50.000h (L80B10).

**Driver: multipower** > 50.000 h Power factor ≥0,95.

**Product compliant with directives:**

## Dati fotometrici - Photometric data

LED Syros QR - QC - 60x60

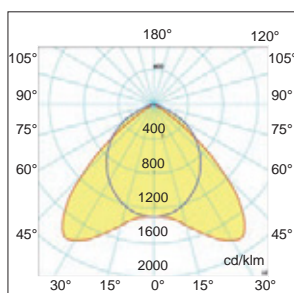

LED Syros RR - RC - 30x120

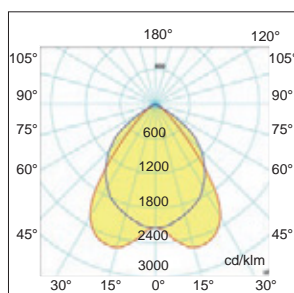



### Ottica Dark Light contro l'abbagliamento - Anti-glare dark light optics

Gli apparecchi Dark Light limitano il pericolo di abbagliamento diretto e riflesso riducendo la luminanza nella direzione di osservazione, in riferimento a degli angoli limite. Indicati per postazioni di lavoro con videotermini.

*Dark Light devices limiting the danger of direct glare and reflection by reduction of the luminance in the direction of the relative point of observation, regarding the limit angles. Suitable for workstations with video terminals.*

**Limite della luminanza media per angoli di elevazione di 65° ed oltre. UNI-EN12464-1**

**Limite della luminanza media per angoli di elevazione di 65° ed oltre. UNI-EN12464-1**

Classe dello schermo secondo la ISO 9241-7  
Screen class according to ISO 9241-7

Qualità dello schermo  
Screen quality

Luminanza media degli apparecchi che sono riflessi nello schermo  
Medium luminance of devices reflected in the screen

Parametri LED Syros - LED Syros parameter

	I	II	III
	Buona Good	Media Average	Bassa Low
	≤ 1.000 cd x m <sup>-2</sup>		≤ 200 cd x m <sup>-2</sup>

#### Collegamento rapido Quick connection



Per una più rapida installazione tutti i modelli di incasso sono dotati di cavo con morsetto per collegamento rapido.

*For faster installation, all the flush mounting models are equipped with a cable with a terminal for quick connection.*

#### Pellicola di protezione Protective film

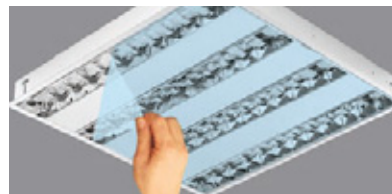

Dotata di pellicola di protezione di serie per non sporcare il corpo lampada e le ottiche, in fase di trasporto e di installazione.

*Standard equipped with protective film so as not to dirty the bulb body and the optics during transport and installation, for maximum equipment performance.*

#### LED performance LED performance



Fattore di potenza ≥0,95 - mantenimento del flusso luminoso minimo al 80%: 50.000h (L80B10) - Temperatura colore 4000K, a richiesta 3000K, 6000K.

*≥0.95 power factor - maintenance of minimum luminous flux to 80%: 50.000h (L80B10) - Colour temperature 4000K, 3000K, 6000K on request.*

### UGR Indice di abbagliamento - Unified Glare Rating

UGR	Classificazione valori UGR in funzione delle applicazioni. UGR value classification based on application.
≤ 16	<b>Applicazioni molto impegnative</b> (disegni tecnici, lavoro a videoterminale). <b>Highly demanding applications</b> (technical drawings, working with video display terminals).
≤ 19	<b>Uffici e scuole</b> (lettura, scrittura, riunioni). <b>Offices and schools</b> (reading, writing, meetings).
≤ 22	Applicazioni industriali, artigianato. <b>Industrial, artisanal applications.</b>
>28	Abbagliamento elevato. <b>High glare.</b>

#### Fattore di abbagliamento UGR<19

Valore contemplato secondo la norma (coefficiente di riflessione: soffitto 0,7 - pareti 0,5).

#### Factor glare UGR<19

Value calculated according to the standard (reflection coefficient: ceiling 0.7 - walls 0.5)

L'UGR è l'indicatore dell'abbagliamento diretto derivante dall'impianto di illuminazione. La norma Europea per l'illuminazione dei posti di lavoro in interni **UNI-EN12464-1** richiede un valore UGR specifico per ogni applicazione, compreso tra 10 e 30. Più è basso il valore, minore è l'abbagliamento.

Il valore esatto di tale indice è da calcolare su progetto in quanto dipende dalla disposizione degli apparecchi illuminanti, dalle caratteristiche dell'ambiente (dimensioni, riflessioni) e dal punto di osservazione.

*UGR is the indicator to assess the direct glare coming from a lighting system.*

*The UNI-EN12464-1 European standard for lighting indoor workplaces requires a specific UGR value for every application, ranging between 10 and 30. The lower the value, the lower the glare.*

*The exact value of this rating must be calculated in the design, as it depends on how the lighting fixtures are arranged, the features of the space (dimensions, reflections), and the viewpoint.*

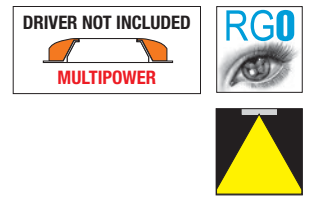
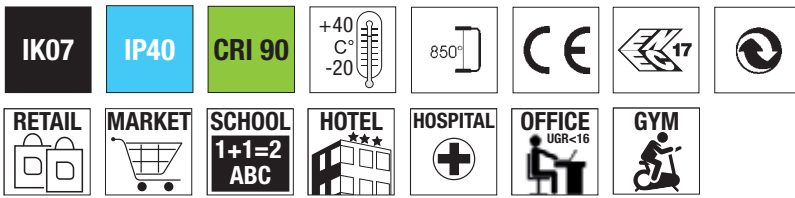

### LED Syros QR

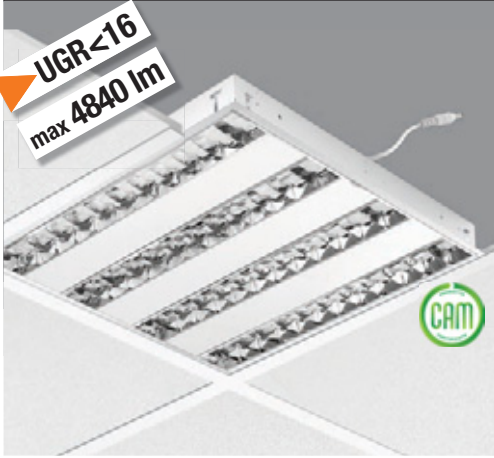

**UGR<16**  
max 4840 lm

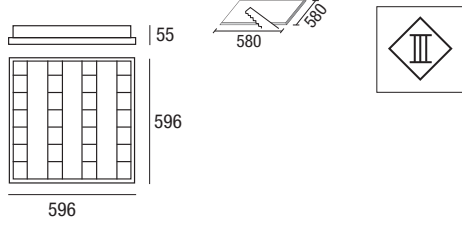

on demand 617mm

colour	W max	lm output max	K	pcs/pallets	Kg	S+L
B	44	4840	3000	60	3.00	25933/B/3K
B	44	4840	4000	60	3.00	25933/B

A richiesta versione 6000K: (consegna 30gg.) **On demand 6000K versions:** (delivery 30 days)

### LED Syros RR

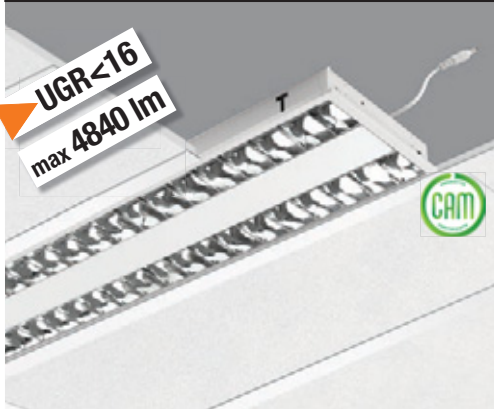

**UGR<16**  
max 4840 lm

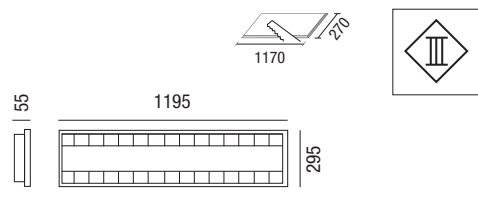

colour	W max	lm output max	K	pcs/pallets	Kg	S+L
B	44	4840	4000	60	3.750	25936/B

A richiesta versione 3000K e 6000K: (consegna 30gg.) **On demand 3000K and 6000K versions:** (delivery 30 days)

Recessed-ceiling-suspended



## Tabella di scelta potenza driver LED - LED Power supply table choice

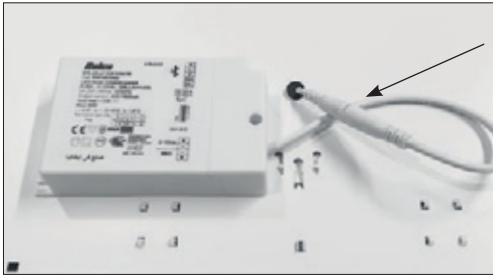

Driver con connessione rapida  
Driver with fast connection.

LED driver multipower

**RN9164/FAST (ON-OFF)**

**RN9164-1-10VF (0-10V)**

**RN9168/DAFAST (DALI, PUSH,0-10V)**

**RN9182DAPUFAS (DALI2 PUSH)**

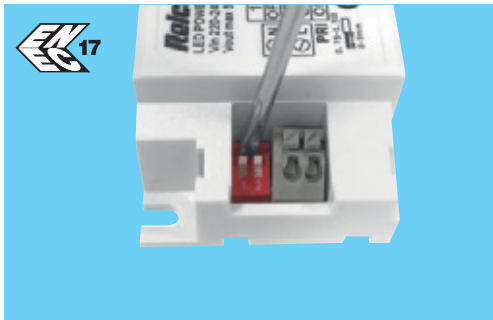

Fornito di dip switch per la selezione della corrente in uscita. Il driver incluso nella confezione è normalmente settato a 38W (vedi tabella). Se necessario è possibile diminuire o aumentare la potenza e di conseguenza i lumen output.

*Equipped with dip switch for selecting the current output. The driver included inside the package is usually set to 38W (see table). If necessary it is possible to decrease or increase the power and consequently the lumen output.*

Taratura Dip-switch	Potenza Power	Lm Output
mA	Watt	Lm
800	33	3630
900	38	4180
950	40	4400
1050	44	4840

Taratura standard di fabbrica  
Driver Standard factory setting

## Accessori non inclusi - Not included accessories

Cod. 65151LED80CP3

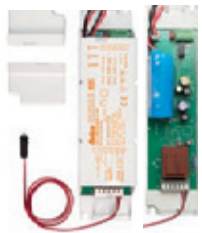

Cod. RP0714CP3

**AUTOTEST**



Cod. 65151LED80CP3

**L240x P59x H40**

Kit emergenza 3W - 3h/12% 180÷250 Vac  
180÷250 Vac - 3h/12% - 3W emergency kit

Cod. RP0714CP3 - **AUTOTEST**

**L195x P55x H42**

Kit emergenza 3W - 3h/12% 180÷250 Vac  
180÷250 Vac - 3h/12% - 3W emergency kit

### Apparecchi di illuminazione cablati in emergenza

Relco nella politica di offrire un servizio migliore alla clientela, ha deciso di utilizzare nei suoi apparecchi di illuminazione dotati di emergenza, solo INVERTER PER EMERGENZA CON AUTOTEST.

*Relco in its policy of offering a better service to customers, has decided to use only EMERGENCY INVERTER WITH SELF-TEST in its luminaires equipped with emergency.*

Le norme europee EN 1838, EN 60598-2-22, relative ai sistemi di illuminazione di emergenza, impongono che periodicamente, siano effettuati dei test per verificare sia il funzionamento sia l'efficienza (durata in emergenza) degli apparecchi di illuminazione che svolgono anche la funzione di illuminazione di emergenza. Questo costringe i manutentori dell'impianto ad interrompere la linea di alimentazione ed effettuare test con cadenza settimanale (test funzionale), e con cadenza trimestrale o annuale (test di autonomia).

Con i nostri kit di emergenza con autotest (conformi alla normativa europea EN 62034) queste prove vengono svolte automaticamente con cadenza programmabile in fase di installazione. Inoltre il nostro inverter analizza i tempi di normale accensione e spegnimento dell'apparecchio ed effettua (qualora possibile) i test nelle ore di assenza delle persone.

Eventuali anomalie sono segnalate tramite un indicatore (led) rosso verde.

A partire dal colore della segnalazione è possibile stabilire in maniera univoca gli eventuali problemi di funzionamento come evidenziato nella tabella seguente.

*The European standards EN 1838, EN 60598-2-22, relating to emergency lighting systems, require that tests be periodically carried out to verify both the functioning and the efficiency (duration in emergency) of the lighting fixtures which also the emergency lighting function. This forces the system maintainers to interrupt the power supply line and carry out tests on a weekly basis (functional test), and on a quarterly or annual basis (autonomy test).*

*With our emergency kits with self-test (complying with European standard EN 62034) these tests are carried out automatically with a programmable cadence during installation.*

*Furthermore, our inverter analyzes the normal switching on and off times of the appliance and carries out (where possible) the tests in the hours when people are absent.*

*Any anomalies are signaled by a red-green indicator (led). Starting from the color of the signal, it is possible to unequivocally establish any functioning problems as shown in the following table.*

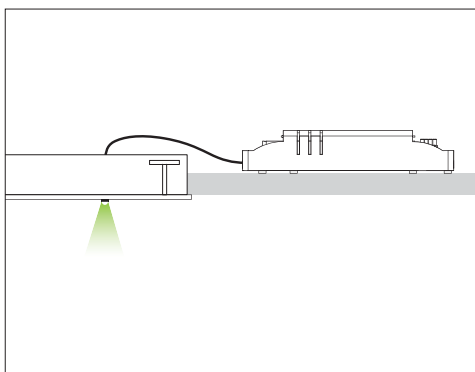

Colore LED - LED indication	Stato - Status
Verde fisso - Permanent Green	Batteria carica o in carica - Battery charge or charging
Verde lampeggiante - Flashing Green	Funzione TEST avviata - TEST in progress
Verde lampeggiante lento (1s ON - 1s OFF) Slow flashing green (1s ON - 1s OFF)	TEST di autonomia avviato Autonomy TEST in progress
Rosso fisso - Permanent Red	Lampada guasta - Lamp failure
Rosso lampeggio veloce (0,1s ON - 0,1s OFF) Fast flashing Red (0,1s ON - 0,1s OFF)	Guasto circuito di ricarica - Charging failure
Lampeggio Rosso lento (1s ON - 1s OFF) Slow flashing Red (1s ON - 1s OFF)	Batteria guasta - Battery failure
Verde e Rosso OFF - Green and Red OFF	Emergenza ON - Emergency ON

GIOVEDÌ 21 AGOSTO  
 10:36  
 EuroPasta Sviluppo 11. Settembre 2017  
 Postitaliano

PRENOTAZIONE	SPORTELLO
PT 001	01
€ 035	04
€ 034	05
1 019	01
1 018	05
020	02

SPORTELLO 03

SPORTELLO 04  
€ 035

SPORTELLO 05  
€ 034

4

5





## LED Syros QC - plafone - ceiling

UGR < 16  
max 4840 lm

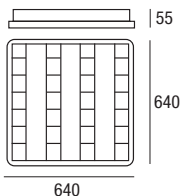

220  
240V

50/60  
Hz

IP65 ON DEMAND versione standard 250 euro  
standard version 250 euro

	colour	W max	lm output max	K	pcs/pallets	Kg	CELL
	B	44	4840	4000	60	3.30	25933/102
	B	44	4840	4000	60	3.30	25933/102DALI
	B	44	4840	4000	60	3.30	25933102DAPU

LED Driver multipotenza incluso nella confezione - LED driver multipower included inside the package  
A richiesta: versione 3000K e 6000K (consegna 30gg.) On demand: 3000K and 6000K versions (delivery 30 days)

## LED Syros RC - plafone - ceiling

UGR < 16  
max 4840 lm

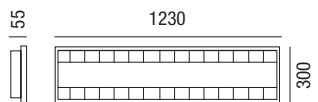

220  
240V

50/60  
Hz

	colour	W max	lm output max	K	L (mm)	pcs/pallets	Kg	CELL
	B	44	4840	4000	1230	60	4.10	25936/104
	B	44	4840	4000	1230	60	4.10	25936/104DALI
	B	44	4840	4000	1230	60	4.10	25936104DAPU

## Accessori non inclusi - Not included accessories

### KIT SOSPENSIONE - SUSPENSION KIT Cod. 31300



Cod. 31300  
Kit sospensione con cavo 2 m che consente di installare LED Syros Q e LED Syros R. Si consiglia l'installazione mantenendo una distanza di almeno 50/60 cm tra soffitto e plafoniera.  
Suspension kit with 2 m cable allows the suspended mounting of the LED Zante Q and LED Syros R. We recommend leaving at least 50/60cm between the ceiling and the lamp when installing it.



### Cavetto di sicurezza in acciaio - Safety steel wire

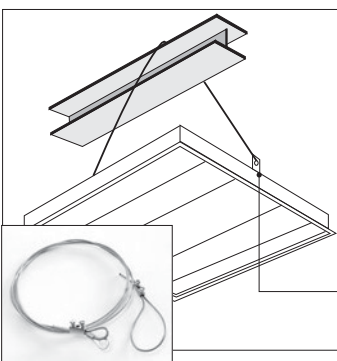

Cod. 000/210  
Kit sicurezza 1500mm, Ø1,5mm.  
Cavetto acciaio anticaduta per LED Syros da incasso.  
Safety Kit 1500mm, Ø 1,5mm. Steel fall arrest cable for flush mounting LED Syros

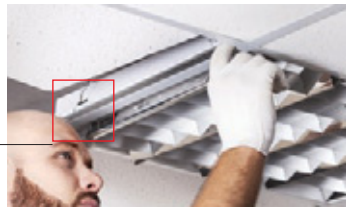

### Kit staffe fissaggio per cartongesso - Recessed bracket kit



Cod. 000120  
"Kit staffe da incasso" per installazione in controsoffitti in cartongesso continuo.  
"Recessed bracket kit" for installation in cardboard false ceiling.



# RILEVATORI DI PRESENZA INFRAROSSI - INFRARED PRESENCE DETECTOR

	Code	W	VA	n°	V	Hz	ta °C
<b>0-10V</b>	<b>HIR22</b>	500 *	250 *	max 15	220-240	50/60	-20...50

	Code	V <sub>dc</sub>	n°	Hz	ta °C
<b>DALI 2</b>	<b>HIR23</b>	9,5÷22,5	max 64	8 mA	-20...50

Rilevatore di PRESENZA ad infrarossi passivi con uscita DALI o 0-10V per la gestione di LED Driver dimmerabili; con crepuscolare per impostazione soglia Lux ambiente di intervento.

Il sensore "percepisce" le variazioni di temperatura provocate dal movimento di persone o animali di grossa taglia entro la zona di copertura, accendendo e regolando automaticamente la luce in base al livello dei LUX impostato. Lo spegnimento si avrà, dopo l'arresto del movimento, in base al tempo precedentemente impostato. Grazie alle sue particolari lenti, il rilevatore, è in grado di percepire non solo il movimento ma anche la PRESENZA di uno o più individui all'interno dell'ambiente controllato.

**Passive infrared PRESENCE detector with DALI or 0-10V output for dimmable LED Drivers; with twilight function in Lux threshold setting within the range of intervention.**

The sensor "perceives" variations in temperature caused by the movement of people or big animals within the covered area, which automatically turns on the light, which is also based on the previously set level of environmental LUX. Shutdown will take place shortly after the motion within the range of detection stops, according to the previously set time.

Thanks to its particular lenses, the detector is able to perceive not only the movement but also the PRESENCE of one or more individuals within the controlled environment.

## Installazione ad incasso - Recessed installation

Rilevatore di PRESENZA infrarossi  
Infrared PRESENCE detector



Dimensioni (mm) - Dimensions (mm)

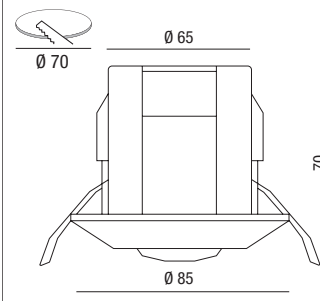

Ampiezza rilevamento - Detection width

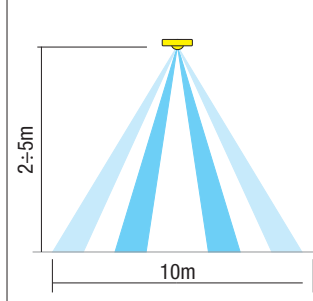

Angolo di rivelamento: 360°

Altezza di montaggio: 2-5 metri

Ampiezza rilevamento: Ø 10m

Assorbimento stand by: < 0,5W

Detection angle: 360°

Assembly height: 2-5 metres

Detection Width: Ø 10m

Stand-by absorption: < 0,5W



	Code	V <sub>dc</sub>	n°	ta °C
	<b>ES-GL01</b>	1-10	1...6	-20...50



Sistema di controllo dell'efficienza energetica, facile da usare, sicuro e pratico. Il sensore adotta la tecnologia di regolazione 1-10Vdc. in grado di sfruttare al massimo la luce naturale per aumentare l'efficienza energetica e ridurre i consumi.

Safe and practical energy efficiency control system. The sensor uses 1-10Vdc regulation technology capable of fully exploiting natural light to increase energy efficiency and to reduce consumption.

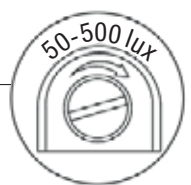
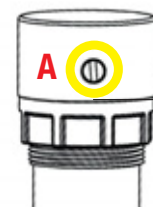

**A** Potenziometro per la regolazione del livello di luce.  
Potentiometer for adjusting target light level.

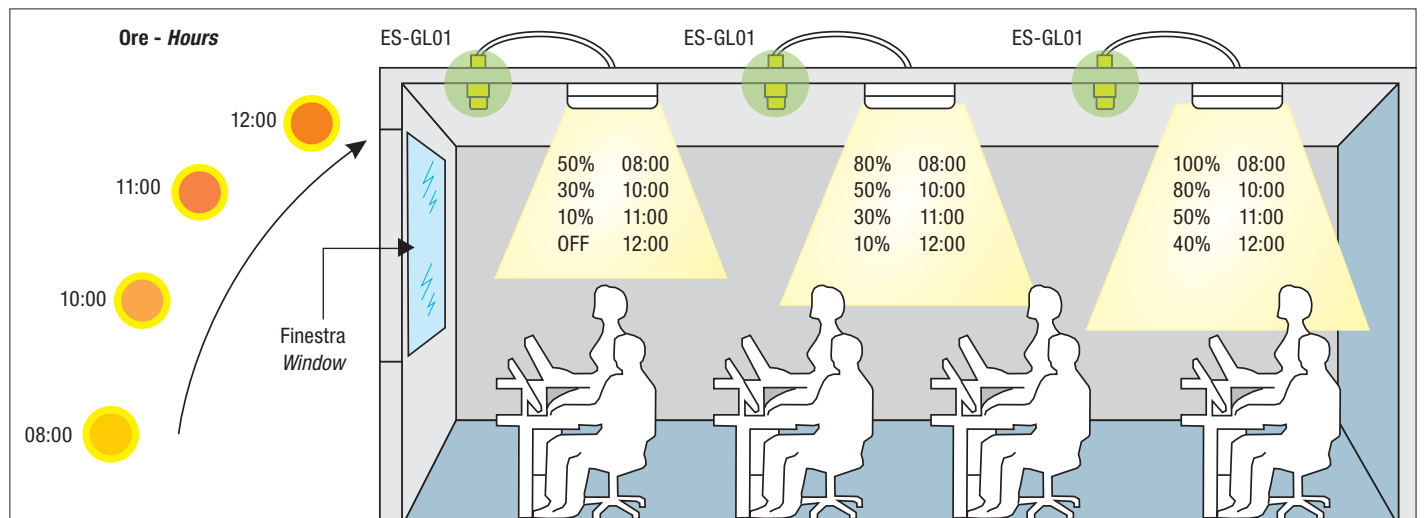

## LED Patmos lens R-C

A RICHIESTA  
ON DEMAND



Apparecchio a LED da incasso versione Backlite, di forma innovativa che garantisce una distribuzione ottimale della luce, adatto per controsoffitti a vista. Ideale per spazi di lavoro in cui è necessaria una luce diffusa perfettamente omogenea e un maggiore controllo dell'abbagliamento, conforme agli standard di comfort visivo ( $UGR \leq 17$ ).

**Installazione:** ad incasso in appoggio sulla struttura a "T" del controsoffitto, ad incasso in controsoffitti di cartongesso (con accessori di montaggio), a plafone (con accessori di montaggio), a sospensione (con accessori di montaggio).

**Corpo e telaio:** struttura in lamiera di acciaio elettrozincata, cornice in alluminio estruso EN AW 6060, verniciati con polvere termoindurente poliestere.

**Verniciatura:** di tipo poliestere eseguita a polvere. Colore bianco RAL 9010.

**Ottica:** diffondente con lenti secondarie in PMMA ad alta trasparenza e anti-ingiallimento.

**Diffusore:** PMMA di spessore 2mm.

**UGR:** Conforme alla norma EN 12464-1 -  $\leq 17$ .

**Temperatura colore:** di serie 3000K 4000K.

**Conforme alla norma:** EN60598-1, RG0 nessun rischio fotobiologico ai fini della norma EN62471.

**Led:** mantenimento del flusso luminoso minimo al 80%: 50.000h (L80B10).

**Driver:** multipotenza . Fattore di potenza  $\geq 0,95$ .

**Prodotto conforme alle direttive:**

*Backlite version recessed LED luminaire, with an innovative shape that guarantees optimal light distribution, suitable for exposed false ceilings. Ideal for work spaces where perfectly homogeneous diffused light and greater glare control are required, compliant with visual comfort standards ( $UGR \leq 17$ ).*

**Installation:** lay-in installation on T-beams of false ceiling, recessed use in plasterboard false ceilings (with mounting accessories), ceiling use (with mounting accessories), suspended use (with mounting accessories).

**Body and frame:** structure made by galvanized steel sheet, frame made by EN AW 6060 extruded aluminum, coated with polyester thermoset powder.

**Coating:** coated with powdered polyester. RAL 9010 white color.

**Optic:** diffused with secondary lenses in high transparency and anti-yellowing PMMA.

**Diffuser:** PMMA with 2mm thickness.

**UGR:** According to Standard EN 12464-1 -  $\leq 17$

**Color temperature:** standard 4000K, 3000K.

**According to standard:** EN60598-1, RG0 exempt from photo-biological risks in compliance with standard EN62471.

**Led:** maintenance of minimum luminous flux to 80%: 50.000h (L80B10).

**Driver:** multipower. Power factor  $\geq 0,95$ .

**Product compliant with directives:**



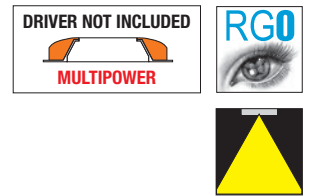
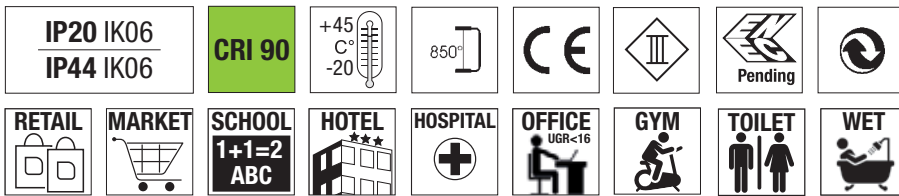

### LED Patmos QR lens

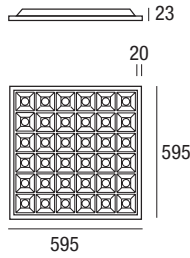

colour	W max	lm output max	K	pcs/pallets	Kg	S+L
B	40	4800	4000	60	3.00	24933/B4K

### Dati fotometrici Photometric data

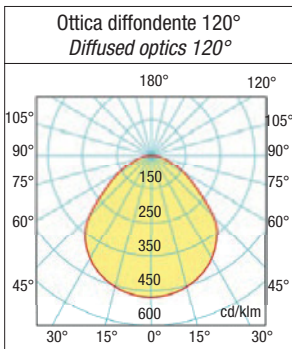

### Connessione rapida Rapid connection



Per una più rapida installazione tutti i modelli da incasso sono dotati di cavo con morsetto per collegamento rapido.  
*For quicker installation, all the recessed models are equipped of dedicated cable with fast connection terminal.*

### Facilità di installazione Easy installation

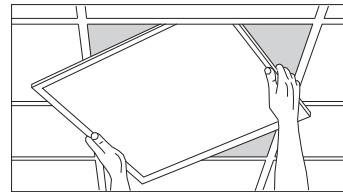

Facilità di installazione: connessione rapida senza necessità di apertura dell'apparecchio, facilmente inseribile nel plafone. Dopo l'installazione il prodotto non richiede manutenzione.  
*Easy installation: quick connection without having to open the device, easily installed in the ceiling. The device requires no maintenance after installation.*

### Flicker free



Luce uniforme per garantire un'ottimale protezione agli occhi.  
*flicker for greater eye protection.*

### Accessori non inclusi - Not included accessories



### Driver con connessione rapida Driver with fast connection



LED driver multipower   
**RN9164/FAST (ON-OFF)**  
**RN9164-1-10VF (0-10V)**  
**RN9168/DAFAST (DALI, PUSH,0-10V)**  
**RN9182DAPUFAS (DALI2 PUSH)**



### Cod. 65151LED80CP3

Kit emergenza 3W - 3h/12% 180÷250 Vac  
180÷250 Vac - 3h/12% - 3W emergency kit

### Cod. RP0714CP3 - AUTOTEST

Kit emergenza 3W - 3h/12% 180÷250 Vac  
180÷250 Vac - 3h/12% - 3W emergency kit

### Tabella di scelta potenza driver LED - LED Power supply table choice



Fornito di dip switch per la selezione della corrente in uscita. Il driver incluso nella confezione è normalmente settato a 34W (vedi tabella). Se necessario è possibile diminuire o aumentare la potenza e di conseguenza il lumen output.

**Equipped with dip switch for selecting the current output.** The driver included inside the package is usually set to 34W (see table). If necessary it is possible to decrease or increase the power and consequently the lumen output.

Taratura Dip-switch	Potenza Power	Lm Output
mA	Watt	Lm
800	29	3480
900	34	4080
950	36	4320
1050	40	4800

Taratura standard di fabbrica  
Driver Standard factory setting



**Accessori non inclusi - Not included accessories**

**Kit sicurezza; cavo di sicurezza in acciaio**  
*Security Kit; safety steel wire*

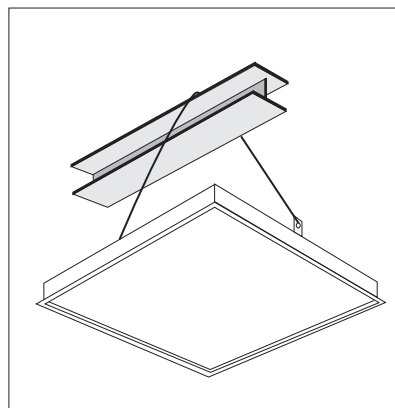

**Cod. 000/210**

Kit sicurezza: Lunghezza 1500mm,  
Ø 1,5mm. Cavo in acciaio anticaduta  
per Led Zante da incasso.  
*Security kit. Length 1500mm, Ø1,5mm.  
Anti-fall steel cable for recessed Led Zante*



**Cod. 000/211**

Ganci per Kit sicurezza  
*Hooks for security kit*

**Kit sospensione**  
*Suspension Kit*



**Cod. 000102-M**

**Cod. 31300**

Kit sospensione con cavo 2m che consente di installare LED Patmos sospesa (per essere sospesa necessita anche dell' accessorio **Cod. 000102-M** cassaforma per installazione a plafone).  
Si consiglia l'installazione mantenendo una distanza di almeno 50/60cm tra soffitto e plafoniera.

*Suspension kit with 2 m cable allows the suspended mounting of the LED Zante Q and LED Zante R (also add accessory **Cod. 000102-M** formwork for ceiling installation).  
We recommend leaving at least 50/60cm between the ceiling and the lamp when in-*

Montaggio per cartongesso - *Mounting for plasterboard*

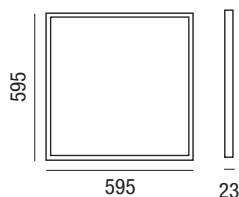

**Cod. 25930/CLIPS**

4 molle di fissaggio per installazione ad incasso in controsoffitti di cartongesso + 8 viti  
 4 fixing springs for recessed installation on plasterboard false ceiling + 8 screws

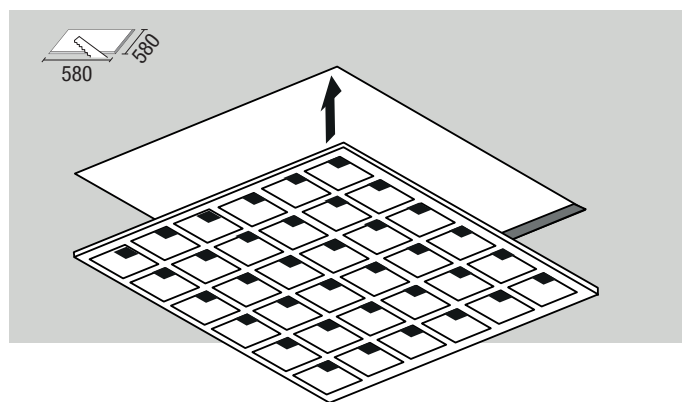

Montaggio a plafone - *Ceiling mounting*

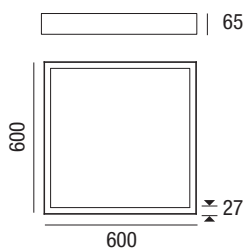

**Cod. 000102-M**

Cassaforma per installazione a **plafone**. Questo accessorio consente di montare LED Patmos direttamente a soffitto. La cassaforma è composta da un telaio componibile in lamiera verniciata bianca, costituito da quattro elementi ad incastro e viti a corredo.

*Coffer for ceiling installation. This accessory makes it possible to install the LED Patmos directly on a ceiling. The framework is composed of a modular frame in white painted sheet, consisting of four interlocking elements and screws supplied.*

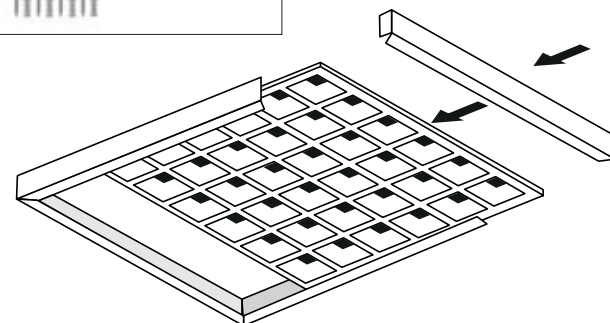

Recessed

## LED Egeo R-C

A RICHIESTA  
ON DEMAND

0-10V

DALI 2



Serie di apparecchi a LED per aree comuni, corridoi, scale, laboratori, strutture sanitarie, sale riunioni, negozi, adatte per controsoffitti a vista. Per ambienti dove sia necessaria una luce diffusa perfettamente omogenea. Ideale per spazi di lavoro in cui è necessario un maggiore controllo dell'abbagliamento, grazie allo schermo microprismatizzato che fornisce un'illuminazione ottimale e rispettosa delle normative sul comfort visivo ( $UGR \leq 16$ ).

**Installazione:** ad incasso in appoggio sulla struttura a "T" del controsoffitto, a plafone (con accessori di montaggio), a sospensione (con accessori di montaggio).

**Corpo e telaio:** struttura in lamiera di acciaio elettrozincata, cornice in alluminio estruso EN AW 6060.

**Verniciatura:** di tipo poliestere eseguita a polvere. Colore bianco RAL 9010.

**Ottica:** lastra in policarbonato diffondente.

**Schermo:** microprismatizzato di spessore 2mm.

**UGR:** Conforme alla norma EN 12464-1 -  $\leq 16$ .

**Temperatura colore:** 4000K.

**Conforme alla norma:** EN60598-1, RG0 nessun rischio fotobiologico ai fini della norma EN62471.

**Led:** mantenimento del flusso luminoso minimo al 80%: 50.000h (L80B10).

**Driver multipotenza:** non incluso, fattore di potenza  $\geq 0,95$  conforme alle norme.

*Luminaire for recessed, ceiling or suspended installation designed to light up spaces requiring perfectly homogeneous diffused light.*

*It is suitable for modular false ceilings with exposed structure (lay-in installation) where it's necessary a higher glare control, the models with micro-prismatic shield supply an ideal lighting complying standards about visual comfort ( $UGR \leq 16$ ).*

**Installation:** lay-in installation on T-beams of false ceiling, ceiling use (with mounting accessories), suspended use (with mounting accessories).

**Body and frame:** structure made by galvanized steel sheet, frame made by EN AW 6060 extruded aluminum.

**Coating:** coated with powdered polyester. RAL 9010 white color.

**Optic:** polycarbonate sheet diffusing.

**Shield:** opal or micro-prismatic engineering plastic sheet with 2mm thickness.

**UGR:** According to Standard EN 12464-1 -  $\leq 16$

**Color temperature:** 4000K.

**According to standard:** EN60598-1, RG0 exempt from photo-biological risks in compliance with standard EN62471.

**Led:** maintenance of minimum luminous flux to 80%: 50.000h (L80B10).

**Driver multipower:** not included. Power factor  $\geq 0,95$ , compliant with standards.



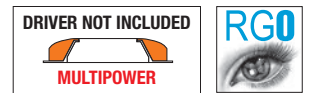
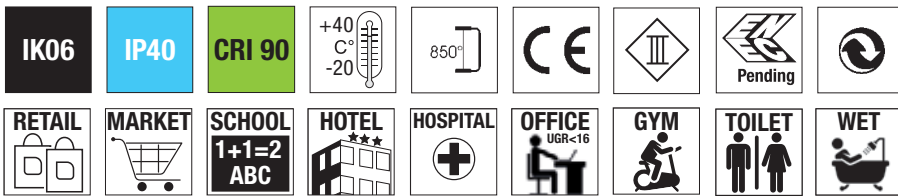

### LED Egeo Q

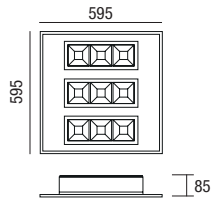
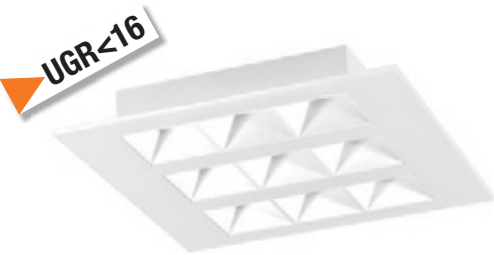

colour	W max	Lm output	K	pcs	Kg	S+L
B	35	4350	4000	001	3,50	27390-B

### LED Egeo R

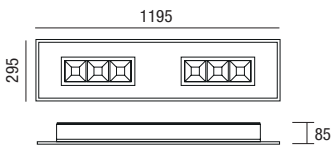

colour	W max	Lm output	K	pcs	Kg	S+L
B	35	4350	4000	001	3,50	27391-B

#### Connessione rapida Rapid connection



Per una più rapida installazione tutti i modelli da incasso sono dotati di cavo con morsetto per collegamento rapido.  
For quicker installation, all the recessed models are equipped of dedicated cable with fast connection terminal.

#### Facilità di installazione Easy installation

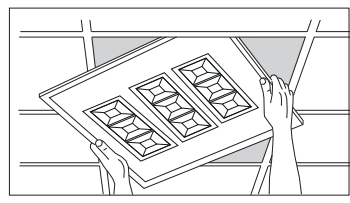

Facilità di installazione: connessione rapida senza necessità di apertura dell'apparecchio, facilmente inseribile nel plafone. Dopo l'installazione il prodotto non richiede manutenzione.  
Easy installation: quick connection without having to open the device, easily installed in the ceiling. The device requires no maintenance after installation.

#### Flicker free



Luce uniforme per garantire un'ottimale protezione agli occhi.  
Uniform light with no flicker for greater eye protection.

#### Dati fotometrici Photometric data

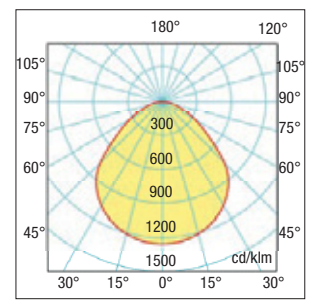

Recessed-ceiling-suspended

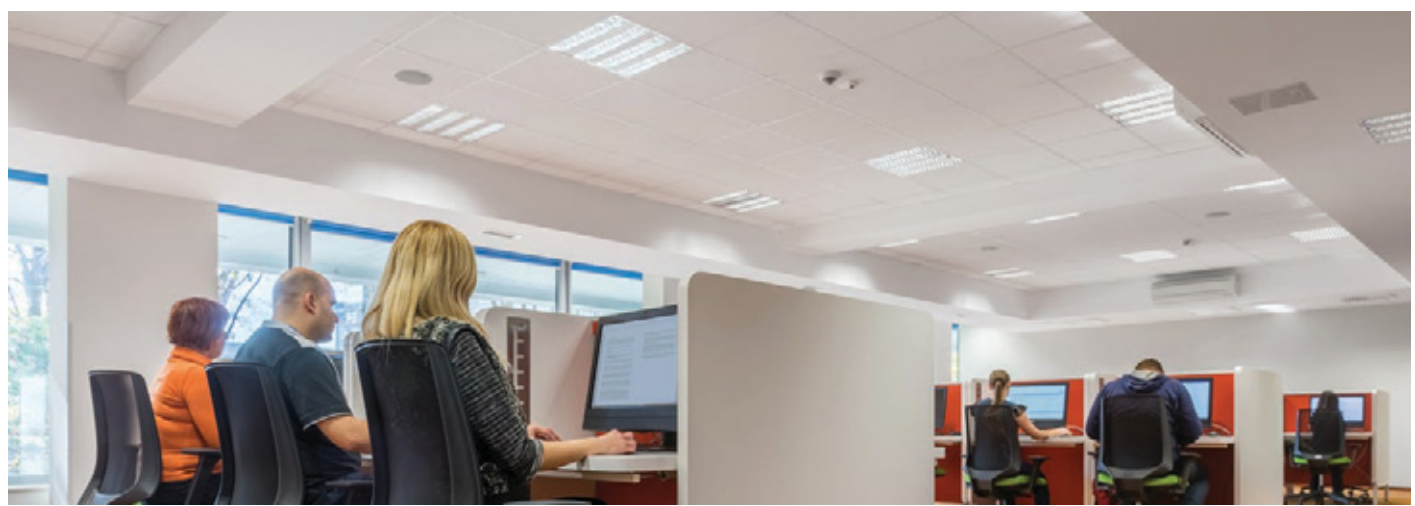



## Accessori non inclusi - Not included accessories



### Cod. 31300

Kit sospensione con cavo 2 m che consente di installare LED Egeo Q e R. Si consiglia l'installazione mantenendo una distanza di almeno 50/60cm tra soffitto e plafoniera.

*Suspension kit with 2 m cable allows the suspended mounting of the LED Egeo Q and R. We recommend leaving at least 50/60cm between the ceiling and the lamp when installing it.*

## LED DRIVER Multipower

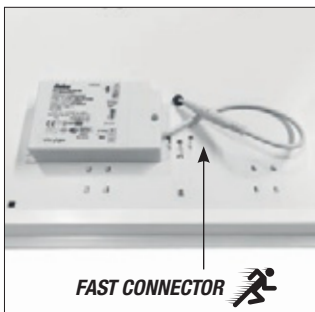

Driver con connessione rapida  
Driver with fast connection.

LED driver multipower

**RN9164/FAST**

**RN9164-1-10VF (0-10V)**

**RN9168/DAFAST (DALI, PUSH,0-10V)**

**RN9182DAPUFAS (DALI2 PUSH)**

## Kit emergenza - Emergency kit



### Cod. 65151LED80CP3

Kit emergenza 3W - 3h/12% 180÷250 Vac  
180÷250 Vac - 3h/12% - 3W emergency kit

### Cod. RP0714CP3 - AUTOTEST

Kit emergenza 3W - 3h/12% 180÷250 Vac  
180÷250 Vac - 3h/12% - 3W emergency kit

## Tabella di scelta potenza driver LED - LED Power supply table choice



Fornito di dip switch per la selezione della corrente in uscita. Il driver incluso nella confezione è normalmente settato a 35W (vedi tabella). Se necessario è possibile diminuire o aumentare la potenza e di conseguenza i lumen output.

*Equipped with dip switch for selecting the current output. The driver included inside the package is usually set to 35W (see table). If necessary it is possible to decrease or increase the power and consequently the lumen output.*

Taratura Dip-switch	Potenza Power	Lm Output
mA	Watt	Lm
800	33	3630
900	38	4180
950	40	4400
1050	44	4840
Taratura standard di fabbrica Driver Standard factory setting		



### Cassaforma per installazione a plafone (non incassata).

Questo accessorio consente di montare LED Egeo Q e LED Egeo R direttamente a soffitto. La cassaforma è composta da un telaio componibile in lamiera verniciata bianca, costituito da quattro elementi ad incastro e 4 viti a corredo.

### Coffer for ceiling installation (not recessed).

*This accessory makes it possible to install the LED Egeo Q e LED Egeo R directly on a ceiling. The framework is composed of a modular frame in white painted sheet, consisting of four interlocking elements and 4 screws supplied.*

### Cod. 27390/CF LED Egeo Q 600x600mm

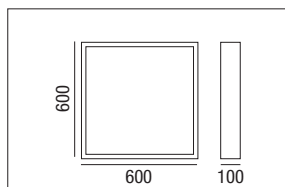

### Cod. 27391/CF LED Egeo R 300x1200mm

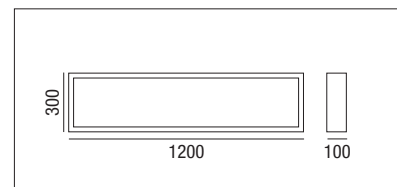

## LED Zante R-C

A RICHIESTA  
ON DEMAND



Serie di apparecchi a LED per aree comuni, corridoi, scale, laboratori, strutture sanitarie, sale riunioni, negozi, adatte per controsoffitti a vista. Per ambienti dove sia necessaria una luce diffusa perfettamente omogenea. Ideale per spazi di lavoro in cui è necessario un maggiore controllo dell'abbagliamento, grazie allo schermo microprismatizzato che fornisce un'illuminazione ottimale e rispettosa delle normative sul comfort visivo ( $UGR \leq 19$ ).

Per applicazioni in uffici ove ci siano attività lavorative svolte al videoterminale si consiglia l'utilizzo della serie SYROS o EGEO che hanno un maggior confort visivo grazie al  $UGR < 16$ .

**Installazione:** ad incasso in appoggio sulla struttura a "T" del controsoffitto, ad incasso in controsoffitti di cartongesso (con accessori di montaggio), a plafone (con accessori di montaggio), a sospensione (con accessori di montaggio).

**Corpo e telaio:** struttura in lamiera di acciaio elettrozincata, cornice in alluminio estruso EN AW 6060, verniciati con polvere termoindurente poliestere.

**Verniciatura:** di tipo poliestere eseguita a polvere. Colore bianco RAL 9003.

**Ottica:** diffondente. Composta da lastra in tecnopolimero (MS).

**Schermo:** in materiale PMMA microprismatizzato, spessore 2mm.

**UGR:** Conforme alla norma EN 12464-1 -  $\leq 19$ .

**Temperatura colore:** standard 4000K a richiesta 3000K e 6000K.

**Conforme alla norma:** EN60598-1, RG0 nessun rischio fotobiologico ai fini della norma EN62471.

**Led:** mantenimento del flusso luminoso minimo al 80%: 50.000h (L80B10).

**Driver:** multipotenza . Fattore di potenza  $\geq 0,95$ .

**Prodotto conforme alle direttive:**

*Luminaire for recessed, ceiling or suspended installation designed to light up spaces requiring perfectly homogeneous diffused light. It is suitable for modular false ceilings with exposed structure (lay-in installation) where it's necessary a higher glare control, the models with micro-prismatic shield supply an ideal lighting complying standards about visual comfort ( $UGR \leq 19$ ).*

*For applications in offices where there are work activities carried out at the video terminal, the use of the SYROS or EGEO series is recommended, which have a greater visual comfort thanks to the  $UGR < 16$ .*

**Installation:** lay-in installation on T-beams of false ceiling, recessed use in plasterboard false ceilings (with mounting accessories), ceiling use (with mounting accessories), suspended use (with mounting accessories).

**Body and frame:** structure made by galvanized steel sheet, frame made by EN AW 6060 extruded aluminum, coated with polyester thermoset powder.

**Coating:** coated with powdered polyester. RAL 9003 white color.

**Optic:** diffused. Engineering plastic sheet (MS).

**Shield:** PMMA micro-prismatic engineering plastic sheet with 2mm thickness.

**UGR:** According to Standard EN 12464-1 -  $\leq 19$

**Color temperature:** standard 4000K, 3000K and 6000K on request.

**According to standard:** EN60598-1, RG0 exempt from photo-biological risks in compliance with standard EN62471.

**Led:** maintenance of minimum luminous flux to 80%: 50.000h (L80B10).

**Driver:** multipower. Power factor  $\geq 0,95$ .

**Product compliant with directives:**



Diffusore microprismatizzato in PMMA 0,75mm  
PMMA microprismatic diffuser 0,75mm

**UGR<19**

Recessed-ceiling-suspended

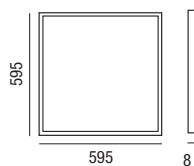
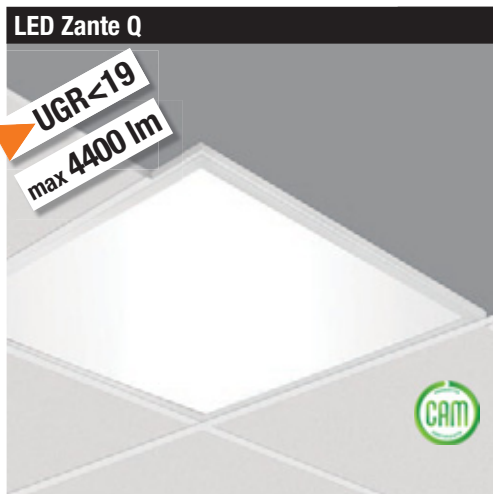
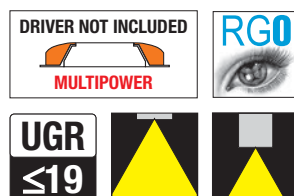
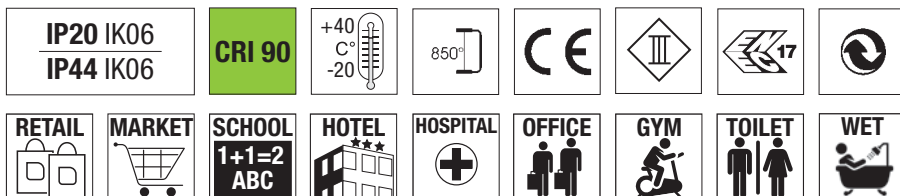

**NEW packaging**  
- In confezione da 10pcs.  
- 10 pcs packs.

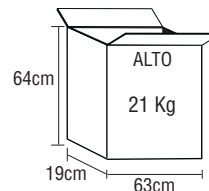

**A richiesta:** versione 3000K e 6000K (consegna 90gg.)  
**On demand:** 3000K and 6000K versions (delivery 90 days)

colour	W max	Lm output	K	pcs	Kg	S+L
B	44	max 4400	3000	012	2,00	25932/B
B	44	max 4400	4000	012	2,00	25930/B

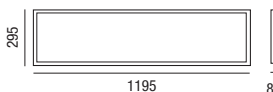
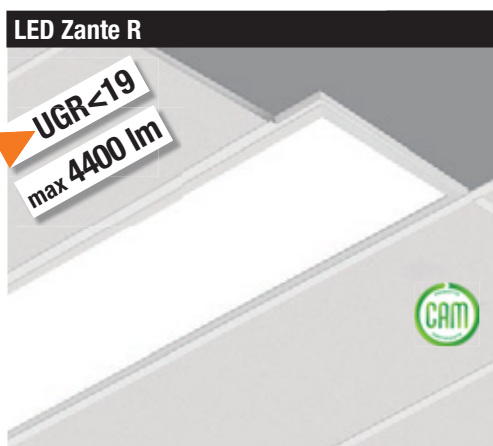

**NEW packaging**  
- In confezione da 10pcs.  
- 10 pcs packs.



**A richiesta:** versione 3000K e 6000K (consegna 90gg.)  
**On demand:** 3000K and 6000K versions (delivery 90 days)

colour	W max	lm output	K	Kg	S+L
B	44	max 4400	4000	3,20	26013/B

### Accessori non inclusi - Not included accessories

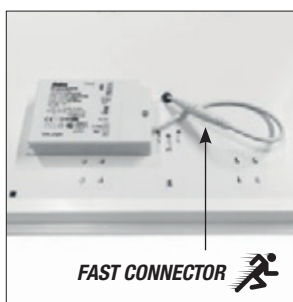

Driver con connessione rapida  
Driver with fast connection.

LED driver multipower   
**RN9164/FAST (ON-OFF)**  
**RN9164-1-10VF (0-10V)**  
**RN9168/DAFAST (DALI, PUSH,0-10V)**  
**RN9182DAPUFAS (DALI2 PUSH)**



**Cod. 65151LED80CP3**  
Kit emergenza 3W - 3h/12% 180÷250 Vac  
180÷250 Vac - 3h/12% - 3W emergency kit

**Cod. RP0714CP3 - AUTOTEST**  
Kit emergenza 3W - 3h/12% 180÷250 Vac  
180÷250 Vac - 3h/12% - 3W emergency kit

### Tabella di scelta potenza driver LED - LED Power supply table choice

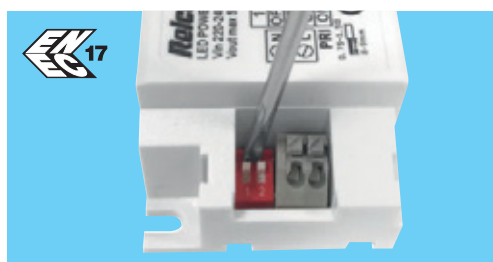

Fornito di dip switch per la selezione della corrente in uscita. Il driver incluso nella confezione è normalmente settato a 38W (vedi tabella). Se necessario è possibile diminuire o aumentare la potenza e di conseguenza i lumen output.

**Equipped with dip switch for selecting the current output.** The driver included inside the package is usually set to 38W (see table). If necessary it is possible to decrease or increase the power and consequently the lumen output.

Taratura Dip-switch	Potenza Power	Lm Output
mA	Watt	Lm
800	33	3300
900	38	3800
950	40	4000
1050	44	4400
Taratura standard di fabbrica Driver Standard factory setting		

**Dati fotometrici**  
**Photometric data**

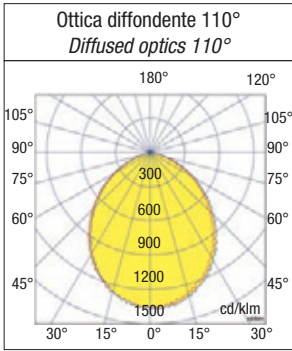

**Connessione rapida**  
**Rapid connection**



Per una più rapida installazione tutti i modelli da incasso sono dotati di cavo con morsetto per collegamento rapido.  
*For quicker installation, all the recessed models are equipped of dedicated cable with fast connection terminal.*

**Facilità di installazione**  
**Easy installation**

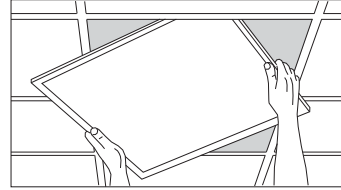

Facilità di installazione: connessione rapida senza necessità di apertura dell'apparecchio, facilmente inseribile nel plafone. Dopo l'installazione il prodotto non richiede manutenzione.  
*Easy installation: quick connection without having to open the device, easily installed in the ceiling. The device requires no maintenance after installation.*

**Flicker free**



Luce uniforme per garantire un'ottimale protezione agli occhi.  
*flicker for greater eye protection.*

**Composizione lampada - Lamp composition**

**Le qualità dello schermo microprismatizzato**

LED Zante è dotato di schermo microprismatizzato per un elevato controllo dell'abbagliamento, creato da una lastra in **PMMA** (Polimetilmetacrilato) un polimero che non ingiallisce e mantiene inalterate le sue caratteristiche nel tempo. La qualità dei materiali utilizzati da Relco garantiscono un mantenimento del flusso luminoso minimo al 80%: **50.000h** (L80B10) un alta resa del colore (**CRI≤90**), assenza di abbagliamento (**UGR≤19**) e basso livello di Flickering.

**The qualities of the microprismatic screen**

LED Zante is equipped with a micro-prismatic screen for high glare control, created from a **PMMA** (Polymethylmethacrylate) plate, a polymer that does not yellow and maintains its characteristics over time. The quality of the materials used by Relco guarantee a minimum luminous flux maintenance at 80%: **50.000h** (L80B10) a high color rendering (**CRI≤90**), absence of glare (**UGR≤19**) and low level of Flickering.

Film E.V.A. (Ethilene vinil acetato) Spessore 2mm  
*E.V.A. film - Thickness 2mm*

Fondo di chiusura in acciaio verniciato Bianco  
*Closure bottom made of steel; White Painted*

Film riflettente - Spessore 0,25mm

Recessed-ceiling-suspended

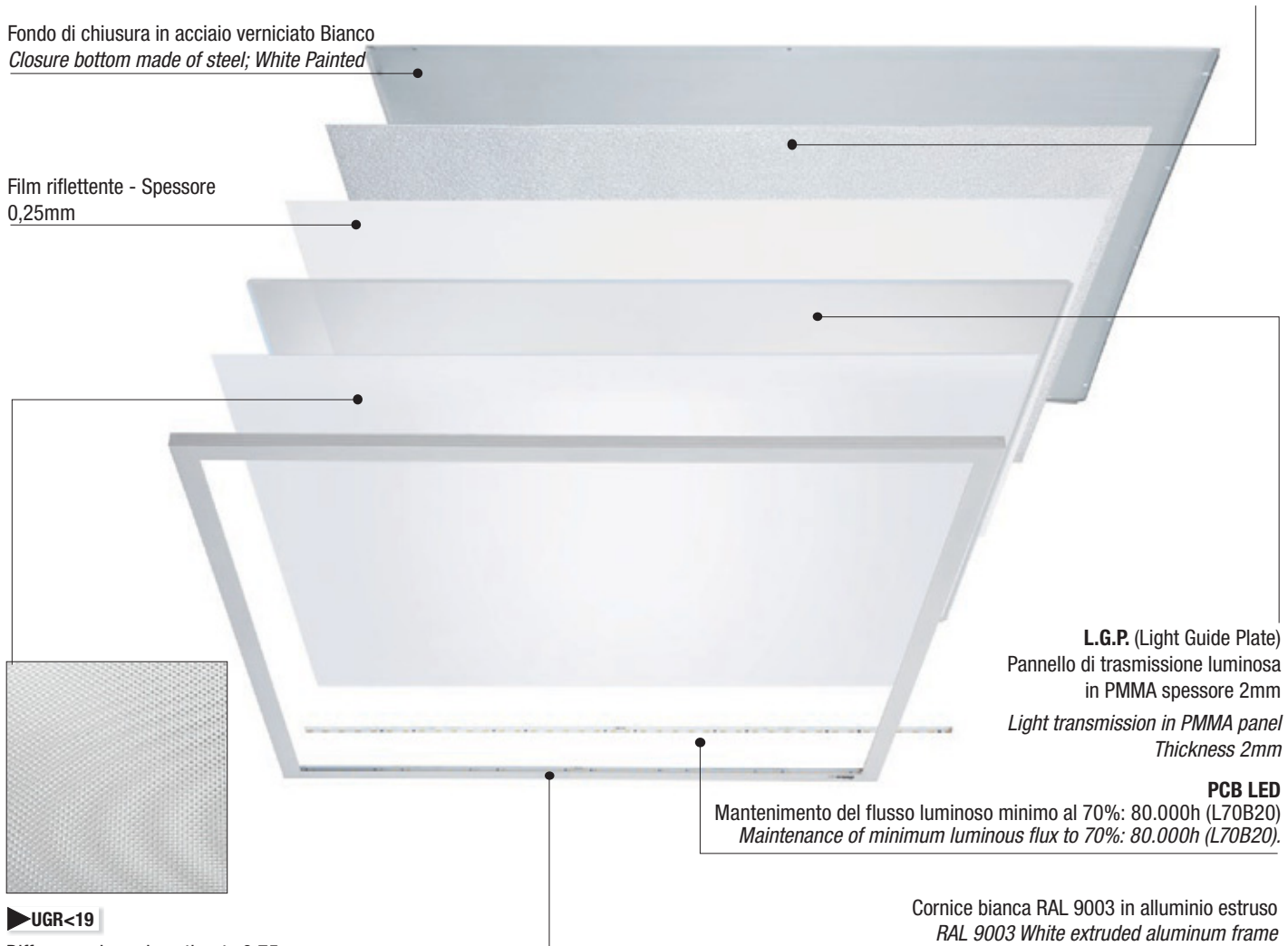

**L.G.P.** (Light Guide Plate)  
Pannello di trasmissione luminosa in PMMA spessore 2mm  
*Light transmission in PMMA panel Thickness 2mm*

**PCB LED**  
Mantenimento del flusso luminoso minimo al 70%: 80.000h (L70B20)  
*Maintenance of minimum luminous flux to 70%: 80.000h (L70B20).*

Cornice bianca RAL 9003 in alluminio estruso  
*RAL 9003 White extruded aluminum frame*

► **UGR<19**

Diffusore microprismatizzato 0,75mm  
*Microprismatic diffuser 0,75mm*





**Kit sicurezza; cavo di sicurezza in acciaio**  
**Security Kit; safety steel wire**

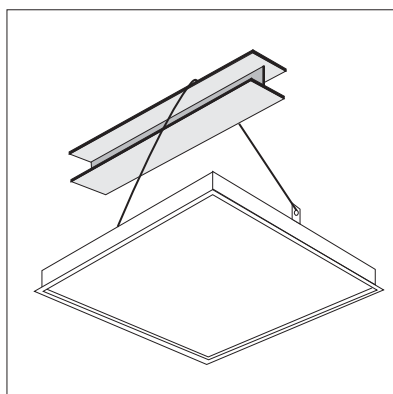

**Cod. 000/210**

Kit sicurezza: Lunghezza 1500mm, Ø 1,5mm. Cavo in acciaio anticaduta per Led Zante da incasso.

*Security kit. Length 1500mm, Ø1,5mm. Anti-fall steel cable for recessed Led Zante*



**Cod. 000/211**

Ganci per Kit sicurezza  
*Hooks for security kit*



**Cod. 31300**

Kit sospensione con cavo 2m che consente di installare LED Zante Q e LED Zante R (aggiungere anche accessorio 000103 cassaforma 300X1200). Si consiglia l'installazione mantenendo una distanza di almeno 50/60cm tra soffitto e plafoniera.

*Suspension kit with 2 m cable allows the suspended mounting of the LED Zante Q and LED Zante R (also add accessory 000103 formwork 300X1200). We recommend leaving at least 50/60cm between the ceiling and the lamp when installing it.*

## Installazione con accessori per plafone cartongesso - Plasterboard accessories ceiling installation

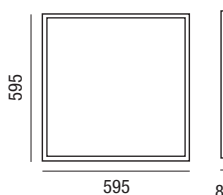

### Cod. 25930/CLIPS

4 molle di fissaggio per installazione ad incasso in controsoffitti di cartongesso + 8 viti  
4 fixing springs for recessed installation on plasterboard false ceiling + 8 screws

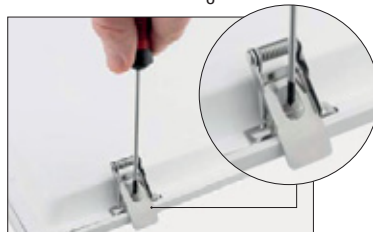
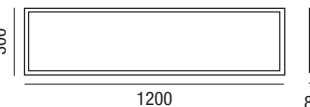
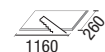

### Cod. 000102 (000102-M)



### Cod. 000102 - LED Zante Q 600x600mm Cod. 000103 - LED Zante R 300x1200mm

Cassaforma per installazione a plafone (non incassata). Questo accessorio consente di montare LED Zante Q e R direttamente a soffitto. La cassaforma è composta da un telaio componibile in lamiera verniciata bianca, costituito da quattro elementi ad incastro e viti a corredo.

Coffer for ceiling installation (not recessed). This accessory makes it possible to install the LED Zante Q or R directly on a ceiling. The framework is composed of a modular frame in white painted sheet, consisting of four interlocking elements and screws supplied.

### Cod. 000102 (000102-M)

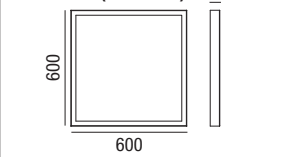

### Cod. 000103 (000103-M)

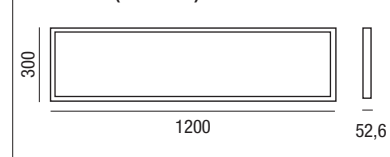

## RILEVATORI DI PRESENZA INFRAROSSI - INFRARED PRESENCE DETECTOR

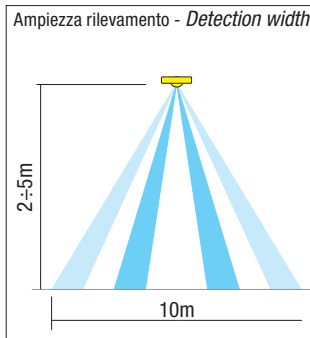
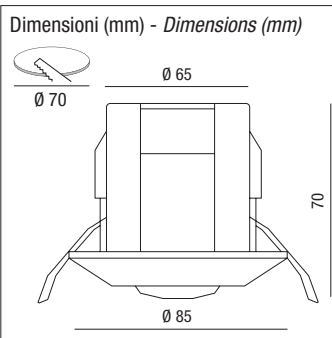

### Angolo di rivelamento:

360°

### Altezza di montaggio:

2-5 metri

### Ampiezza rilevamento:

Ø 10m

### Absorbimento stand by:

< 0,5W

### Detection angle:

360°

### Assembly height:

2-5 metres

### Detection Width:

Ø 10m

### Stand-by absorption:

< 0,5W

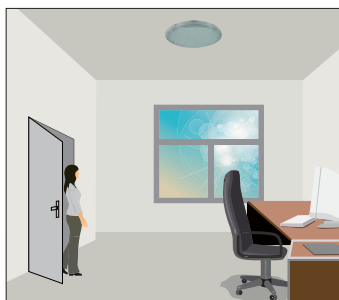

Con sufficiente luce naturale, la luce non si accende quando viene rilevata la presenza.

With sufficient natural light, the light does not switch on when presence is detected

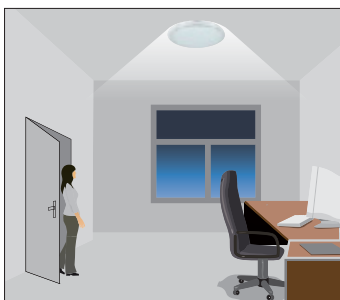

Con luce naturale insufficiente, il sensore accende automaticamente la luce quando viene rilevata la presenza.

With insufficient natural light, the sensor switches on the light automatically when presence is detected.

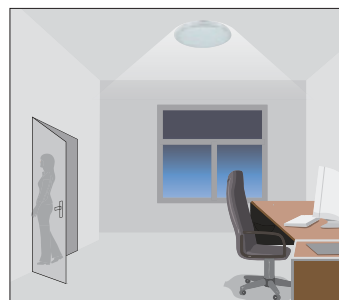

Dopo il tempo di attesa, la luce si attenua al livello di attesa predefinito.

After hold-time, the light dims to stand-by level preset.

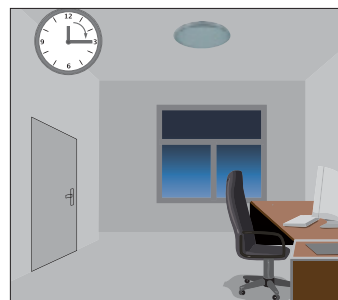

La luce si spegne automaticamente al termine del periodo di stand-by.

Light switches off automatically after the stand-by period elapses.

## LED Milo Backlit

A RICHIESTA  
ON DEMAND

0-10V



Apparecchio a LED per aree comuni, corridoi, scale, laboratori, strutture sanitarie, sale riunioni, negozi, adatte per controsoffitti a vista. Per ambienti dove sia necessaria una luce diffusa perfettamente omogenea. Ideale per spazi di lavoro in cui è necessario un maggiore controllo dell'abbagliamento, grazie allo schermo microprismatizzato che fornisce un'illuminazione ottimale e rispettosa delle normative sul comfort visivo (UGR≤19).

Per applicazioni in uffici ove ci siano attività lavorative svolte al videoterminale si consiglia l'utilizzo della serie SYROS, EGEO o ITACA che hanno un maggior confort visivo grazie al UGR<16.

**Installazione:** ad incasso in appoggio sulla struttura a "T" del controsoffitto.

**Corpo e telaio:** struttura in lamiera di acciaio elettrozincata, cornice in alluminio estruso EN AW 6060, verniciati con polvere termoindurente poliestere.

**Verniciatura:** di tipo poliestere eseguita a polvere. Colore bianco RAL 9003.

**Ottica:** diffondente. Composta da lastra in tecnopolimero (MS).

**Schermo:** Milo Basic - Milo HE diffusore opale.

Milo Plus diffusore prismatizzato.

**Conforme alla norma:** EN60598-1, RGO nessun rischio fotobiologico ai fini della norma EN62471.

**Led:** mantenimento del flusso luminoso minimo al 80%: 50.000h (L80B10).

**Driver:** multipotenza . Fattore di potenza ≥0,95 **da ordinare a parte**.

**Prodotto conforme alle direttive:**

*LED appliance for common areas, halls, stairs, laboratories, healthcare facilities, meeting rooms, shops, suitable for visible false ceilings. For environments requiring perfectly evenly diffused light. Ideal for workspaces which need greater glare control, thanks to the microprismatic screen which provides optimal lighting and complies with standards on visual comfort (UGR≤19).*

*For applications in offices where work is carried out at video terminals, we recommend using the SYROS or EGEO or ITACA series which provide greater visual comfort thanks to UGR<16.*

**Installation:** recessed set on the T-shaped false ceiling structure.

**Body and frame:** electro-galvanised steel sheet structure, EN AW 6060 extruded aluminium frame, coated with thermosetting polyester powder.

**Painting:** powder polyester coating. White RAL 9003.

**Optics:** diffusing. Consisting of techno-polymer sheet (MS).

**Screen:** Milo Basic - Milo HE opal diffuser.

Milo Plus prismatic diffuser.

**Compliant with standard:** EN60598-1, RGO no photobiological risk for the purposes mentioned in standard EN62471.

**LED:** maintenance of 80% minimum luminous flux: 50,000h (L80B10).

**Driver:** multi-power factor ≥0.95 **to be ordered separately**.

**Product compliant with directives:**





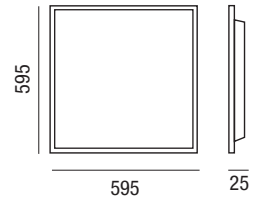

LED Milo Backlit Q

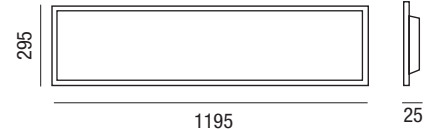

LED Milo Backlit R

	colour	Wmax	Lm output	lm/W	K	pcs	Kg	S+L			
<b>BASIC series</b>	LED Milo Backlit Q 60X60	B	40	max 4400	110	4000	10	1,30	25938/B	UGR ≤ 19*	IP20 IK06 IP44 IK06
		B	40	max 4400	110	4000	10	1,30	25938/65/B	UGR ≤ 19*	IP20 IK06 IP65 IK06
		B	40	max 4400	110	3000	10	1,30	25938/3K/B	UGR ≤ 19*	IP20 IK06 IP44 IK06
<b>BASIC series</b>	LED Milo Backlit R 30X120	B	40	max 4400	110	4000	10	1,30	25938/B30120	UGR ≤ 19*	IP20 IK06 IP44 IK06
		B	40	max 4400	110	4000	10	1,30	2593865B30120	UGR ≤ 19*	IP20 IK06 IP65 IK06
		B	40	max 4400	110	3000	10	1,30	25938B301203K	UGR ≤ 19*	IP20 IK06 IP44 IK06
<b>PLUS series</b>	LED Milo Backlit Q 60X60	B	40	max 4640	116	4000	10	1,30	25938/BPLUS		
		B	40	max 4610	116	3000	10	1,30	25938/BPLUS3K	UGR - 19	IP20 IK06 IP44 IK06
	LED Milo Backlit R 30X120	B	40	max 4640	116	4000	10	1,30	25938BPL30120		



	colour	W	Lm output	lm/W	K	pcs	Kg	S+L	
<b>HE series</b>	LED Milo Backlit Q 60X60	B	40	max 5600	147	4000	10	1,60	25938/BHE

**UGR ≤ 19\*** IP20 IK06 IP44 IK06 Grande vantaggio economico, consumo ridotto e alta efficienza luminosa. *Great economic advantage, low consumption and high luminous efficiency.*

**Dati fotometrici**  
**Photometric data**

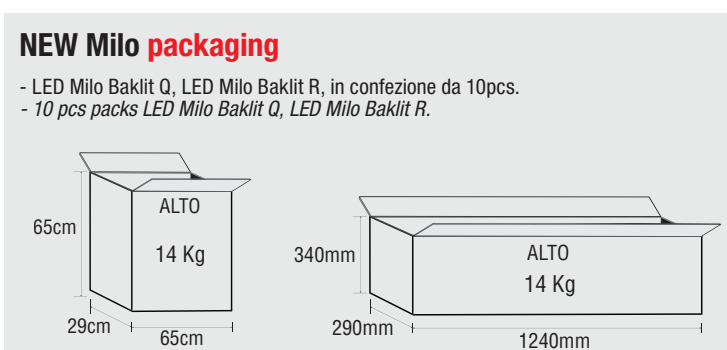
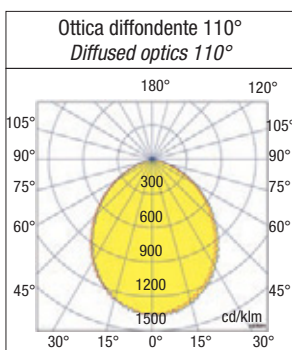

**UGR ≤ 19\***  
\* Valori raggiunti per maggior parte di applicazioni per interni. Verificare con vostro lighting designer in fase di progetto la migliore soluzione illuminotecnica per il vostro ufficio.  
\* Values achieved for most interior applications. Check with your lighting designer during the design phase for the best lighting solution for your office.

Recessed/ceiling

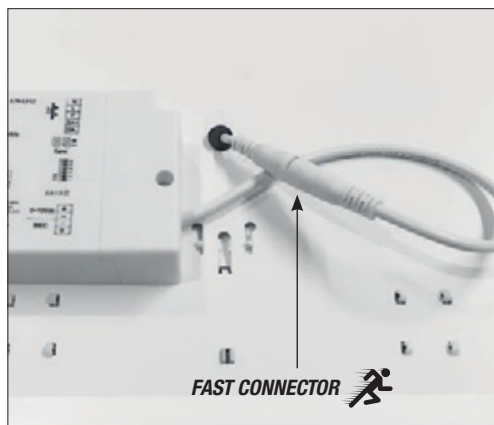

### FAST CONNECTOR

Driver con connessione rapida  
Driver with fast connection.

**STANDARD 900mA**  
per MILO BASIC e PLUS

LED driver multipower

**RN9164/FAST**  
**RN9164-1-10VF (0-10V)**  
**RN9168/DAFAST (DALI, PUSH,0-10V.)**  
**RN9182DAPUFAS (DALI2 PUSH)**

### FAST CONNECTOR

Driver con connessione rapida  
Driver with fast connection.

**STANDARD consigliato**  
**600mA per MILO HE**

LED driver multipower

**RN9163FA60MI**  
**RN9163DFA60MI (0-10V)**  
**RN9168DFA60MI (DALI, PUSH,0-10V.)**  
**RN9182DAP60MI DALI2 PUSH)**

**SCEGLI LA GIUSTA  
CORRENTE PER OTTIMIZZARE  
IL FLUSSO LUMINOSO  
NECESSARIO**  
**CHOOSE THE RIGHT CURRENT  
TO OPTIMIZE THE NECESSARY  
LUMINOUS FLUX**

Taratura Dip-switch	Potenza Power
mA	Watt
800	32
900	36
950	38
1050	40
	Taratura standard di fabbrica Driver Standard factory setting

Possibilità di scegliere la corrente di pilotaggio del LED **max 1050mA**, tenendo presente che la scelta di una corrente più bassa aumenterà l'efficienza e quindi migliorerà il risparmio energetico. In questo modo potrai scegliere il flusso luminoso ideale per ogni progetto illuminotecnico.

*Possibility to choose the driving current of the LED **max 1050mA**, bearing in mind that choosing a lower current will increase efficiency and therefore improve energy savings. In this way you can choose the ideal luminous flux for each lighting project.*

**Accessori non inclusi - cassaforma da assemblare per installazione a plafone e molle di fissaggio per cartongesso**  
**Accessories not included - formwork to be assembled for ceiling installation and fixing springs for plasterboard**

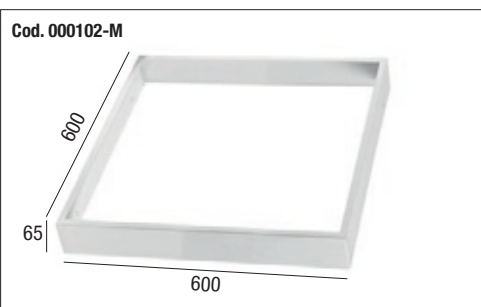

**Cod. 000102-M (versione quadrata)**

Cassaforma da assemblare per installazione **a plafone**. Questo accessorio consente di montare LED Milo Q direttamente a soffitto in modo veloce. La cassaforma è composta da un telaio componibile in lamiera verniciata bianca RAL 9003, costituito da quattro elementi ad incastro.

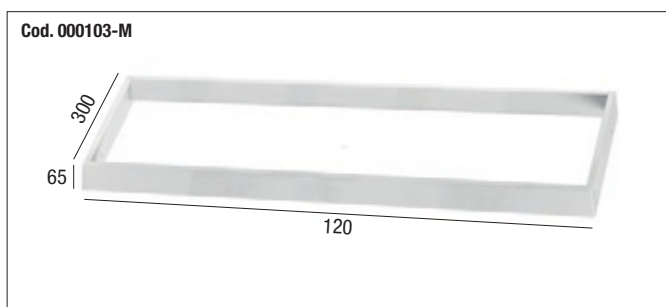

**Cod. 000103-M (rectangular version)**

Frame to be assembled for ceiling **installation**. This accessory makes it possible to install the LED Milo Q directly on a ceiling quickly. The framework is composed of a modular frame in RAL 9003 white painted sheet, consisting of four interlocking elements.

**Cod. 25930/CLIPS**

4 molle di fissaggio per installazione ad incasso in controsoffitti di cartongesso + 8 viti.

4 fixing springs for recessed installation on plasterboard false ceiling + 8 screws.

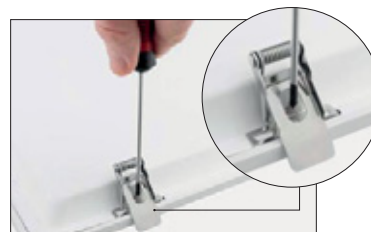
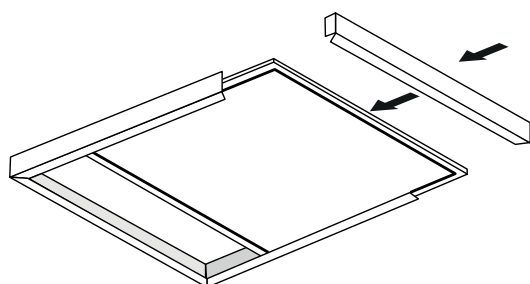

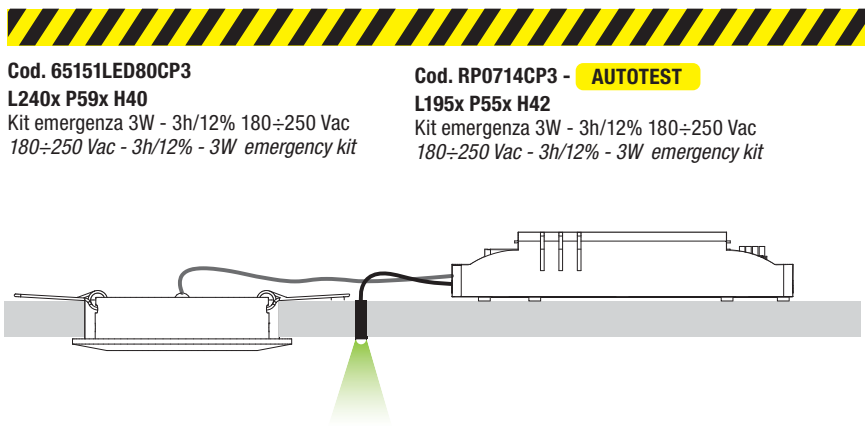

**Cod. 65151LED80CP3**  
**L240x P59x H40**  
 Kit emergenza 3W - 3h/12% 180÷250 Vac  
 180÷250 Vac - 3h/12% - 3W emergency kit

**Cod. RP0714CP3 - AUTOTEST**  
**L195x P55x H42**  
 Kit emergenza 3W - 3h/12% 180÷250 Vac  
 180÷250 Vac - 3h/12% - 3W emergency kit

**VANTAGGI EMERGENZA CON AUTOTEST**  
**ADVANTAGES OF EMERGENCY WITH SELF-TEST**

Il modello Autotest segnala eventuali anomalie (attraverso il Led bicolore Rosso-Verde) che possono presentarsi durante il normale funzionamento della batteria e/o circuito di pilotaggio della lampada a cui è collegato l'inverter.

The Autotest model signals any anomalies (through the two-colour Red-Green LED) that may occur during normal operation of the battery and/or piloting circuit of the lamp to which the inverter is connected

Colore LED - LED indication	Stato - Status
Verde fisso - Permanent Green	Batteria carica o in carica - Battery charge or charging
Verde lampeggiante - Flashing Green	Funzione TEST avviata - TEST in progress
Verde lampeggiante lento (1s ON - 1s OFF) Slow flashing green (1s ON - 1s OFF)	TEST di autonomia avviato - Autonomy TEST in progress
Rosso fisso - Permanent Red	Lampada guasta - Lamp failure
Rosso lampeggio veloce (0,1s ON - 0,1s OFF) Fast flashing Red (0,1s ON - 0,1s OFF)	Guasto circuito di ricarica - Charging failure
Lampeggio Rosso lento (1s ON - 1s OFF) Slow flashing Red (1s ON - 1s OFF)	Batteria guasta - Battery failure
Verde e Rosso OFF - Green and Red OFF	Emergenza ON - Emergency ON

**Possibilità di gestione del punto luce centralizzata o con sensori di presenza / luminosità.**  
**Possibility of managing the centralized light point or with presence / brightness sensors.**

vedi pag. see page  
**215**



**cod. HBTDA**  
 Informazioni prodotto  
 Product information



**cod. HBTDA P**  
 Accessorio per montaggio a plafone  
 Ceiling mount accessory

**Sensore di movimento e crepuscolare con Varialuce integrato:**

- è il **software**, è l'**hardware** del sistema integrato nell'apparecchio.
- Funzione MASTER e SLAVE.
- Dimmer **DALI** in **Bluetooth** 5.0 SIG MESH funzione ON-OFF, temporizzazione.
- Applicazione ad incasso o plafone.

**Motion and twilight sensor with integrated Dimmer:**

- it is the **software**, the **hardware** of the system integrated into the device.
- MASTER and SLAVE function.
- Dimmer **DALI** in **Bluetooth** 5.0 SIG MESH function, timing.
- Recessed or ceiling-mounted application.

	Lenti incluse nella confezione <i>Lenses included in the package</i>	Rilevamento max (DxH) Max detection (DxH)	Asimmetrica <i>Asymmetric</i>	Per corridoi for corridors
Convessa <i>Convex</i>		10m x 3m		
Piatta <i>Flax</i>		9m x 3m		



- Max 40 apparecchi  
Max 40 devices
- Max 35m

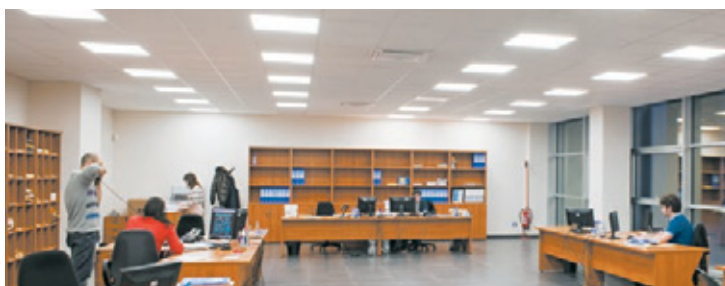

## LED Itaca R-C-S

A RICHIESTA  
ON DEMAND

0-10V

DALI 2



Famiglia di apparecchi a LED ad elevato confort visivo con un bassissimo indice di abbagliamento, pensata per aree comuni, corridoi, scale, laboratori, strutture sanitarie, sale riunioni, negozi. Ideale dove è richiesta un'illuminazione con livelli di abbagliamento minimi. Il bassissimo consumo energetico e le contenute temperature garantiscono una lunga durata al prodotto. L'utilizzo della tecnologia LED garantisce una resa luminosa elevata in relazione al consumo di energia, annullando completamente i costi di manutenzione.

**Installazione:** ad incasso in appoggio alla struttura del controsoffitto.

A plafone e a sospensione (con accessori di montaggio **Cod. 31300**).

**Corpo:** in alluminio verniciato (bianco RAL 9003 versione R-C) (grigio RAL9006 versione S).

**Ottica:** dark-light per una riduzione massima dell'abbagliamento.

**Temperatura di colore:** 4000K (3000K a richiesta, consegna 60 giorni).

**Driver multipotenza** : **da ordinare a parte.**

Con possibilità di diminuzione della potenza (Lm) tramite DIP. Fattore di potenza  $\geq 0,95$ .

**Conforme alla norma:** EN60598-1, RGO nessun rischio fotobiologico ai fini della norma EN62471.

**Led: SMD** Mantenimento del flusso luminoso minimo al 80%: 50.000h (L80B10).

**Prodotto conforme alle direttive:** 

*Range of high visual comfort LED appliances with a very low glare index, designed for public areas, halls, stairs, laboratories, healthcare facilities, meeting rooms, shops. Ideal where light is required with minimal glare levels. Very low energy consumption and low temperatures guarantee a long product life.*

*LED technology guarantees high light output in relation to energy consumption, completely eliminating maintenance costs.*

**Installation:** recessed set on false ceiling structure.

Ceiling and suspension (with assembly accessories **Code 31300**).

**Body:** in painted aluminum (white RAL 9003 R-C version) (grey RAL9006 S version).

**Optic:** dark-light for maximum glare reduction.

**Color temperature:** 4000K (3000K on-demand, delivery in 60 days).

**Multipower driver** : **to be ordered separately.**

With possibility of decreasing power (Lm) by means of DIP switch. Power factor  $\geq 0.95$ .

**According to standard:** EN60598-1, RGO no photobiological risk for the purposes mentioned in standard EN62471.

**Led: SMD** Maintenance of 80% minimum luminous flux: 50,000h (L80B10)..

**Product compliant with directives:** 

### LED Itaca R - incasso/recessed



### LED Itaca C - plafone/ceiling







### LED Itaca RR 30X60

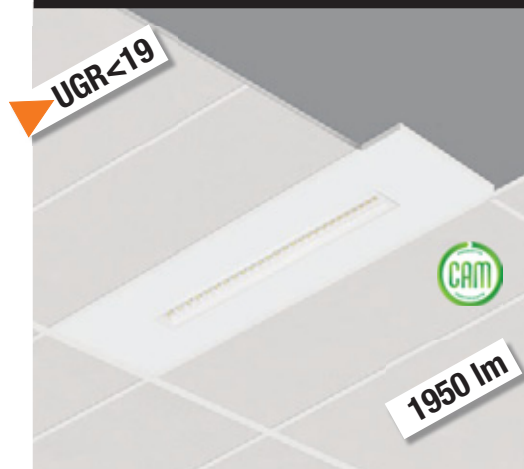

DRIVER NOT INCLUDED

+

Driver con connessione rapida  
 Driver with fast connection.  
 LED driver multipower   
**RN9161FAST350**  
**RN9160DIMFA35 (0-10V)**  
**RN9182DAFA350 DALI 2**

colour	W max	lm output	lm/W	K	Kg	S+L
B	15	1950	130	4000	3,20	25888/3060

### LED Itaca RR 30X120

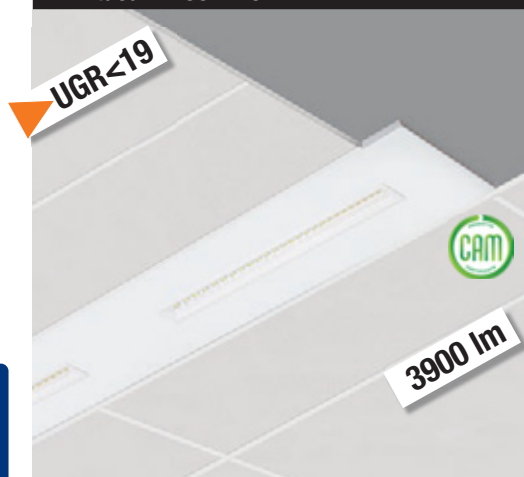

DRIVER NOT INCLUDED

+

Driver con connessione rapida  
 Driver with fast connection.  
 LED driver multipower   
**RN9163FAST700**  
**RN9163DIMFA70 (0-10V)**  
**RN9168DAFA700-DALI-PUSH-010V.**  
**RN9182DAP700F - DALI 2 - PUSH**

colour	W max	lm output	lm/W	K	LxPxH cm	Kg	S+L
B	30	max 3900	130	4000	30x120x5	3,20	25888/30120
B	30	max 3900	130	4000	30x150x5	3,20	25888/30150

A richiesta: aumentando il numero dei moduli si può arrivare alla potenza di 60W  
 On demand: by increasing the number of modules, the power of 60W can be reached

### LED Itaca QR 60X60

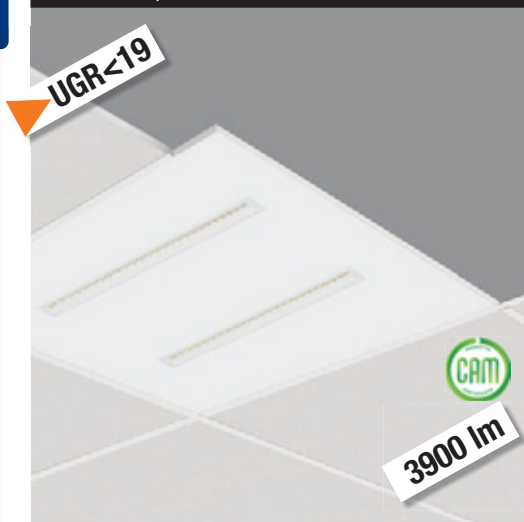

DRIVER NOT INCLUDED

+

Driver con connessione rapida  
 Driver with fast connection.  
 LED driver multipower   
**RN9163FAST700**  
**RN9163DIMFA70 (0-10V)**  
**RN9168DAFA700 - DALI - PUSH - 010V.**  
**RN9182DAP700F - DALI 2 - PUSH**

colour	W max	lm output	lm/W	K	Kg	S+L
B	30	max 3900	130	4000	3,20	25888

A richiesta: aumentando il numero dei moduli si può arrivare alla potenza di 60W  
 On demand: by increasing the number of modules, the power of 60W can be reached

Recessed-ceiling-suspended

LED Itaca RR 60X120

UGR<19

7800 lm

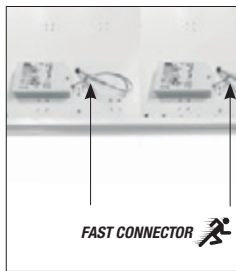
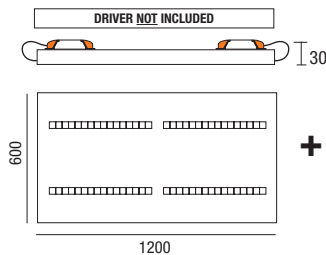

Driver con connessione rapida  
Driver with fast connection.

LED driver multipower   
2x RN9163FAST700  
2x RN9163DIMFA70 (0-10V)  
2x RN9168DAFA700 - DALI-PUSH-010V.  
2x RN9182DAP700F- DALI2 - PUSH

colour	W max	lm output	lm/W	K	Kg	S+L
B	60	max 7800	130	4000	6,40	25888/60120

A richiesta: aumentando il numero dei moduli si può arrivare alla potenza di 60W  
On demand: by increasing the number of modules, the power of 60W can be reached



Recessed-ceiling-suspended

**Connessione rapida**  
**Rapid connection**

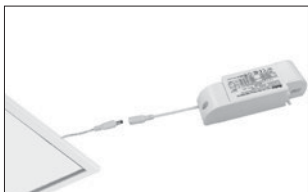

Per una più rapida installazione tutti i modelli da incasso sono dotati di cavo con morsetto per collegamento rapido.  
For quicker installation, all the recessed models are equipped of dedicated cable with fast connection terminal.

**Dati fotometrici**  
**Photometric data**

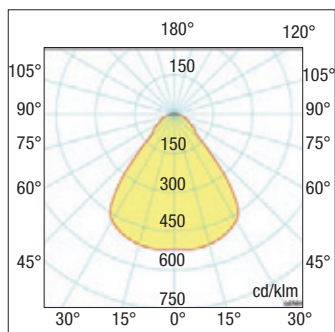

**Accessori non inclusi - Not included accessories**



**Kit emergenza**  
**Emergency kit**

**Cod. 65151LED80CP3**   
Kit emergenza 3W - 3h/12% 180÷250 Vac  
180÷250 Vac - 3h/12% - 3W emergency kit

**Cod. RP0714CP3 - AUTOTEST**  
Kit emergenza 3W - 3h/12% 180÷250 Vac  
180÷250 Vac - 3h/12% - 3W emergency kit

## LED Itaca C Plafone - Surface

A RICHIESTA  
ON DEMAND



### LED Itaca C 15W 30X60 H.4cm

UGR<19

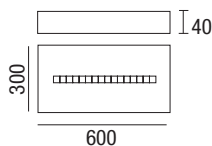

220  
240V

50/60  
Hz



	colour	W max	lm output	lm/W	K	LxPxH cm	Kg	CELL
	B	15	max 1950	130	4000	30x60x4	3,20	25888/3060C
	B	15	max 1950	130	4000	30x60x4	3,20	25888/3060CDA

### LED Itaca C 30W 30X120 H.4cm

UGR<19

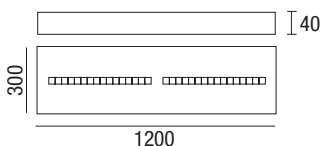

220  
240V

50/60  
Hz



	colour	W max	lm output	lm/W	K	LxPxH cm	Kg	CELL
	B	30	max 3900	130	4000	30x120x4	3,20	25888/30120C
	B	30	max 3900	130	4000	30x120x4	3,20	25888/30120CD

A richiesta: aumentando il numero dei moduli si può arrivare alla potenza di 60W  
On demand: by increasing the number of modules, the power of 60W can be reached

### LED Itaca C 30W 30X150 H.4cm

UGR<19

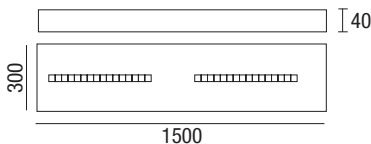

220  
240V

50/60  
Hz



	colour	W max	lm output	lm/W	K	LxPxH cm	Kg	CELL
	B	30	max 3900	130	4000	30x150x4	3,20	25888/30150C
	B	30	max 3900	130	4000	30x150x4	3,20	25888/30150CD

A richiesta: aumentando il numero dei moduli si può arrivare alla potenza di 60W  
On demand: by increasing the number of modules, the power of 60W can be reached

### LED Itaca C 30W 60X60 H.4cm

UGR<19

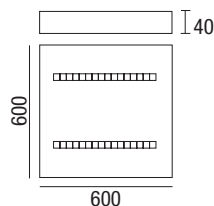

220  
240V

50/60  
Hz



	colour	W max	lm output	lm/W	K	LxPxH cm	Kg	CELL
	B	30	max 3900	130	4000	60x60x4	3,20	25888C
	B	30	max 3900	130	4000	60x60x4	3,20	25888CDA

A richiesta: aumentando il numero dei moduli si può arrivare alla potenza di 60W  
On demand: by increasing the number of modules, the power of 60W can be reached

Recessed



## LED Itaca 60W C 60X120 H.4cm

UGR<19

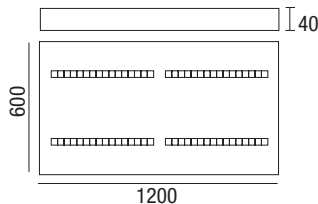
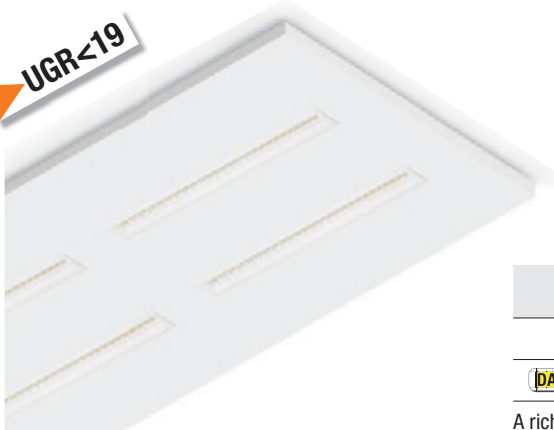

colour	W max	lm output	lm/W	K	LxPxH cm	Kg	CELL	
B	60	max 7800	130	4000	60x120x4	6,40	25888/60120C	
<b>DALI 2</b>	B	60	max 7800	130	4000	60x120x4	6,40	25888/60120CD

A richiesta: aumentando il numero dei moduli si può arrivare alla potenza di 60W  
 On demand: by increasing the number of modules, the power of 60W can be reached

## LED Itaca S - Suspension

### LED Itaca S 30W 30X120 - 30x150 H.6cm

UGR<19

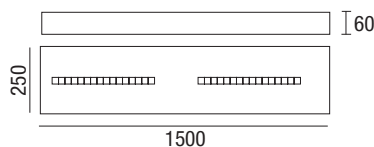
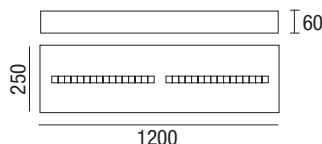

220  
240V

50/60  
Hz



colour	W max	lm output	lm/W	K	LxPxH cm	Kg	CELL	
G	30	max 3900	130	4000	30x120x6	3,20	25888/30120S	
<b>DALI 2</b>	G	30	max 3900	130	4000	30x120x6	3,20	25888/30120SD
G	30	max 3900	130	4000	30x150x6	3,20	25888/30150S	
<b>DALI 2</b>	G	30	max 3900	130	4000	30x150x6	3,20	25888/30150SD

A richiesta: aumentando il numero dei moduli si può arrivare alla potenza di 60W  
 On demand: by increasing the number of modules, the power of 60W can be reached

### Accessori non inclusi - Not included accessories

#### Cod. ITASFC

Staffa per fila continua.  
 Bracket for continuous row.

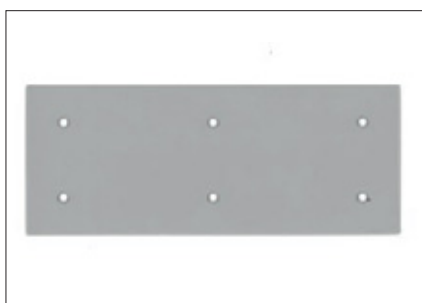

#### Cod. 31300

Kit per sospensione  
 Suspensione Kit



Kit sospensione con cavo 2m che consente di installare LED Itaca S.

Si consiglia l'installazione mantenendo una distanza di almeno 50/60 cm tra soffitto e plafoniera.

*Suspension kit with 2 m cable allows the suspended mounting of the LED Itaca S.*

*We recommend leaving at least 50/60 cm between the ceiling and the lamp when installing it.*

# LED Itaca doghe speciali - Prodotto personalizzato



**LED Itaca, cucita su misura.  
LED Itaca, sewn to measure.**

Recessed-ceiling-suspended

# LED Itaca doghe speciali - Custom product

Apparecchio a LED Custom **UGR<19** per un elevato confort visivo con un bassissimo indice di abbagliamento, in sostituzione retrofit di lampade fluorescenti installate su controsoffitti a doghe. Ideale laddove è richiesta un'illuminazione con livelli di abbagliamento minimi come uffici ed Enti pubblici. Speciale sistema ottico quadrato in cui ogni singolo LED è corredato di lenti per aumentare la resa luminosa. Il bassissimo consumo energetico e le contenute temperature garantiscono una lunga durata al prodotto, inoltre l'utilizzo della tecnologia LED annulla completamente i costi di manutenzione.

**Installazione:** retrofit per lampade fluorescenti su doghe, **adatto per cablaggi in Classe I e Classe II.**

**Corpo:** in alluminio verniciato bianco RAL 9003

**Ottica:** bassa luminanza.

**Potenze disponibili:** **min.18W max.60W.**

**Regolazione:** dimmerabile a richiesta.

**Temperatura di colore:** 4000K (Altre temperature di colore a richiesta).

**Driver multipotenza:** incluso. Fattore di potenza  $\geq 0,95$

**Conforme alla norma:** EN60598-1, RGO nessun rischio fotobiologico ai fini della norma EN62471.

**Led:** Samsung.

Prodotto conforme alle direttive: 

*Custom LED fixture with **UGR<19** for high visual comfort with a very low glare index, replacing retrofit of fluorescent lamps installed on strip false ceilings. Ideal where light is required with minimal glare levels such as offices and public buildings. Special square optic system where each individual LED has a lens to increase the light rendering. The very low energy consumption and the limited temperatures guarantee a long life to the product, moreover the use of the LED technology completely eliminates the maintenance costs.*

**Installation:** retrofit for fluorescent lamps on strips, **suitable for Class I and Class II wiring.**

**Body:** in white painted metal RAL 9003

**Optics:** low luminance.

**Available power:** **min.18W max.60W.**

**Adjustment:** dimmable on request.

**Colour temperature:** 4000K (other colour temperatures on request).

**Multipower driver:** included. Power factor  $\geq 0.95$

**Compliant with standard:** EN60598-1, RGO no photobiological risk for the purposes mentioned in standard EN62471.

**Led:** Samsung.

Product compliant with directives: 

A richiesta  
On demand

**0-10V**



**WIRELESS**



220-240V 50/60Hz



**IK06**

**IP20**

**IK06**

**IP44**

**IK06**

LED Itaca doghe

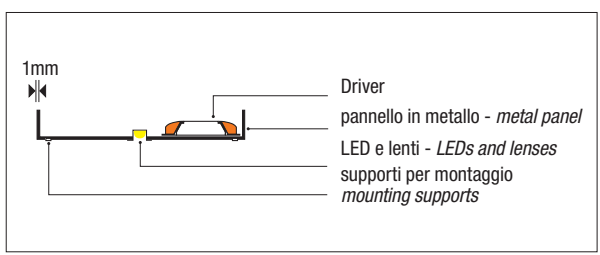
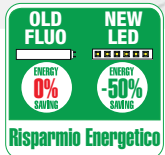

Il seguente articolo è personalizzabile a seconda delle esigenze tecniche ed estetiche del cliente. **Richiedere un preventivo.**

*The following item can be customised according to the customer's technical and aesthetic needs. Request an estimate.*



## Come sostituire i vecchi apparecchi luminosi in 5 minuti, in modo semplice e immediato. How to replace old light fixtures simply and immediately in five minutes.

Rimuovere la griglia, tubo fluorescente e attacchi (dopo aver scollegato l'impianto esistente dall'alimentazione senza necessità di dover smontare) delle vecchie lampade d'incasso su controsoffitto a doghe e sostituire con il nostro kit **LED Itaca doghe UGR<19**. Inviatici il campione dello schermo dark light (fig.1) e del corpo lampada, i nostri tecnici customizzeranno la nuova lampada per un relamping immediato. Il sistema di fissaggio del Kit è perfettamente compatibile con la struttura del canale e permette un aggancio rapido e sicuro del corpo illuminante.

*Remove the grid, fluorescent tube and connections (after disconnecting the existing system from the power supply without the need to disassemble) of your old flush mounted lamps on a strip false ceiling and replace with our kit **UGR<19 LED Itaca strips panel**. Send us the sample of the dark light screen (fig.1) or the lamp body, our technicians will customise the new lamp for immediate relamping. The fixing system of the Kit is perfectly compatible with the structure of the channel and allows a quick and safe attachment of the lighting body.*

Rimuovere la griglia  
Remove the grid



Rimuovere la vecchia lampada fluorescente  
Remove the old fluorescent lamp



Aggianciare LED Itaca tramite i supporti  
Hook the Itaca LEDs on the supports



## LED Mercedes S-C



Serie di apparecchi a LED per ambienti dove sia necessaria una luce diffusa perfettamente omogenea.

**Installazione:** a plafone (con accessori di montaggio inclusi) o sospensione "rigido" solo per diametro 600 o con cavi (con accessori di montaggio non inclusi).

**Corpo e telaio:** struttura in Alluminio verniciato, bianco RAL 9010, nero RAL 9005.

**Verniciatura:** di tipo poliester e eseguita a polvere.

**Diffusore:** lastra in policarbonato diffondente.

**Schermo:** in policarbonato opale di spessore 2mm.

**Temperatura colore:** 3000K - 4000K .

**Led:** mantenimento del flusso luminoso minimo al 80%: 50.000h (L80B10).

**Driver:** conforme alle norme EN55015, EN6100-3-2, EN6100-3-3, EN61347-1, EN61347-2-13, EN61547, EN62384.

Fattore di potenza  $\geq 0,95$ .

**Prodotto conforme alle direttive:** 

*Series of LED devices for environments requiring a perfectly evenly diffused light.*

**Installation:** ceiling (with mounting accessories included) or "rigid" suspension only for diameter 600 or with cables (with mounting accessories not included).

**Body and frame:** structure in painted aluminum, white RAL 9010, black RAL 9005.

**Coating:** coated with powdered polyester.

**Diffuser:** sheet in diffusing polycarbonate.

**Shield:** in 2mm thick opal polycarbonate.

**Color temperature:** 3000k or 4000K.

**Led:** maintenance of 80% minimum luminous flux: 50,000h (L80B10).

**Driver:** in compliant with standards EN55015, EN6100-3-2, EN6100-3-3, EN61347-1, EN61347-2-13, EN61547, EN62384.

Power factor  $\geq 0,95$ .

**Product compliant with directives:** 

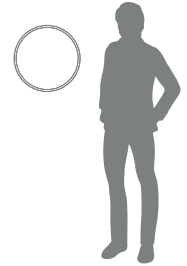
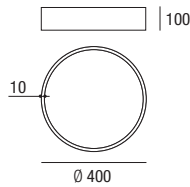
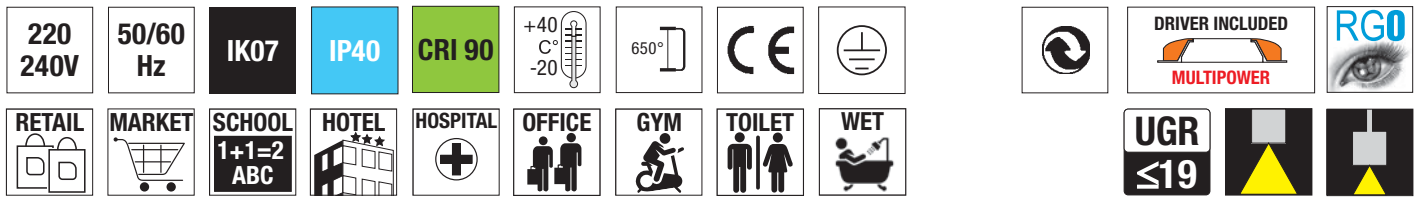

**Dati fotometrici**  
**Photometric data**

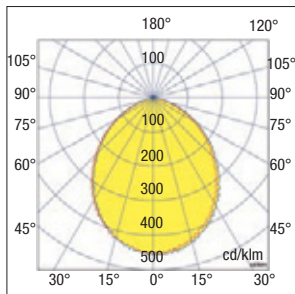

	colour	W max	Lm output	K	pcs	Kg	CELL
	B	24	2184	3000	001	3,50	6024-400
	N	24	2184	3000	001	3,50	6024-400B
	<b>DALI 2</b> PUSH B	24	2184	3000	001	3,50	6024-400110
	<b>DALI 2</b> B	24	2184	3000	001	3,50	6024-400DA
	<b>DALI 2</b> N	24	2184	3000	001	3,50	6024-400BDA
	B	24	2184	4000	001	3,50	6024-400/4K
	N	24	2184	4000	001	3,50	6024-400B/4K
	<b>DALI 2</b> PUSH B	24	2184	4000	001	3,50	6024-4004K110
	<b>DALI 2</b> B	24	2184	4000	001	3,50	6024-400/4KDA
	<b>DALI 2</b> N	24	2184	4000	001	3,50	6024-400B4KDA

**N** RAL 9005 - tempi di consegna 45 giorni - *available in 45 days*

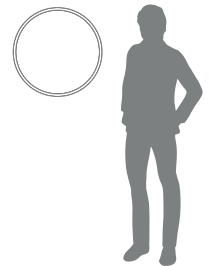
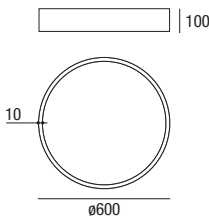

**Dati fotometrici**  
**Photometric data**

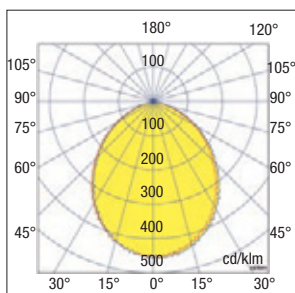

	colour	W max	Lm output	K	pcs	Kg	CELL
	B	45	4095	3000	001	3,50	6048-600
	N	45	4095	3000	001	3,50	6048-600B
	<b>DALI 2</b> PUSH B	45	4095	3000	001	3,50	6048-600110
	<b>DALI 2</b> B	45	4095	3000	001	3,50	6048-600DA
	<b>DALI 2</b> N	45	4095	3000	001	3,50	6048-600BDA
	B	45	4095	4000	001	3,50	6048-600/4K
	N	45	4095	4000	001	3,50	6048-600B/4K
	<b>DALI 2</b> PUSH B	45	4095	4000	001	3,50	6048-6004K110
	<b>DALI 2</b> B	45	4095	4000	001	3,50	6048-600/4KDA
	<b>DALI 2</b> N	45	4095	4000	001	3,50	6048-600B4KDA

**N** RAL 9005 - tempi di consegna 45 giorni - *available in 45 days*

Ceiling/suspended

## LED Mercedes 80 S-C

UGR < 19

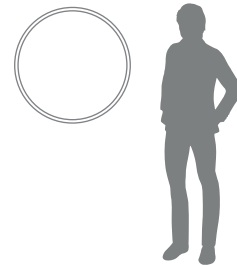
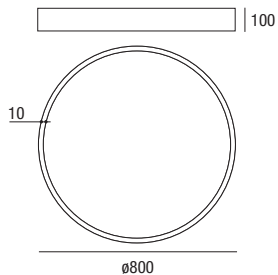

### Dati fotometrici Photometric data

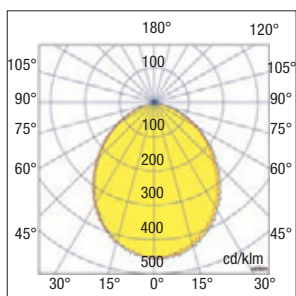

	colour	W max	Lm output	K	pcs	Kg	CELL
	B	80	7280	3000	001	3,50	6048-800
	N	80	7280	3000	001	3,50	6048-800B
	<b>DALI 2</b> PUSH B	80	7280	3000	001	3,50	6048-800110
	<b>DALI 2</b> B	80	7280	3000	001	3,50	6048-800DA
	<b>DALI 2</b> N	80	7280	3000	001	3,50	6048-800BDA
	B	80	7280	4000	001	3,50	6048-800/4K
	N	80	7280	4000	001	3,50	6048-800B/4K
	<b>DALI 2</b> PUSH B	80	7280	4000	001	3,50	6048-8004K110
	<b>DALI 2</b> B	80	7280	4000	001	3,50	6048-800/4KDA
	<b>DALI 2</b> N	80	7280	4000	001	3,50	6048-800B4KDA

**N** RAL 9005 - tempi di consegna 45 giorni - *available in 45 days*

## LED Mercedes 120 S-C

UGR < 19

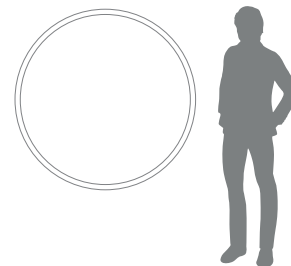
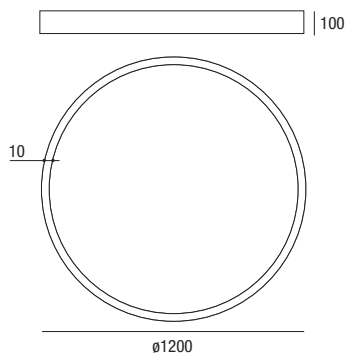

### Dati fotometrici Photometric data

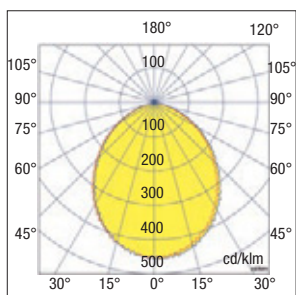

	colour	W max	Lm output	K	pcs	Kg	CELL
	B	120	10900	3000	001	15,50	6048-1200
	N	120	10900	3000	001	15,50	6048-1200B
	<b>DALI 2</b> PUSH B	120	10900	3000	001	15,50	6048-1200110
	<b>DALI 2</b> B	120	10900	3000	001	15,50	6048-1200DA
	<b>DALI 2</b> N	120	10900	3000	001	15,50	6048-1200BDA
	B	120	10900	4000	001	15,50	6048-1200/4K
	N	120	10900	4000	001	15,50	6048-1200B/4K
	<b>DALI 2</b> PUSH B	120	10900	4000	001	15,50	604812004K110
	<b>DALI 2</b> B	120	10900	4000	001	15,50	6048-1200/4KD
	<b>DALI 2</b> N	120	10900	4000	001	15,50	6048-1200B4KD

**N** RAL 9005 - tempi di consegna 45 giorni - *available in 45 days*

## Mercedes Dimmerabile da pulsante a muro (NON-FORNITO)

### Mercedes Dimmable from PUSH-button (NOT SUPPLIED)

Con **DALI 2 PUSH** si possono creare sistemi luminosi che possono essere accesi, spenti e dimmerati in modo semplice, grazie all'utilizzo di pulsanti standard per la gestione della tensione di rete al fine di regolare il flusso luminoso. Una breve pressione del pulsante accende o spegne i driver collegati, invece tenendo premuto il pulsante più a lungo si effettuerà la dimmerazione dei driver collegati.

With **DALI 2 PUSH** it is possible to create lighting systems that can be switched on, off and dimmed in a simple way, thanks to the use of standard buttons for managing the mains voltage in order to regulate the luminous flux. A short press of the button turns the connected drivers on or off, while keeping the button pressed for longer will dim the connected drivers.

### Esempio applicativo - Application example

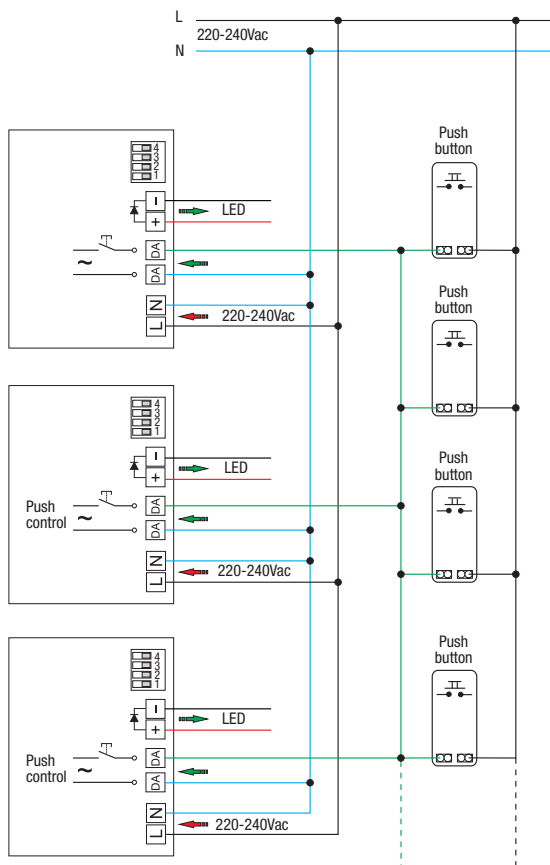

## Mercedes doppia emissione (a richiesta)

### Mercedes double emission (on demand)



### MERCEDES Ø400 - Ø600 - Ø800

#### con doppia emissione

A richiesta per LED Mercedes Ø400 - Ø600 - Ø800 doppia emissione con sovrapprezzo del 50% rispetto al listino.

### MERCEDES Ø400 - Ø600 - Ø800

#### with double emission

On request for LED Mercedes Ø400 Ø600 - Ø800 double emission with a 50% surcharge on the price list.

## Tabella di scelta potenza driver LED - LED Power supply table choice

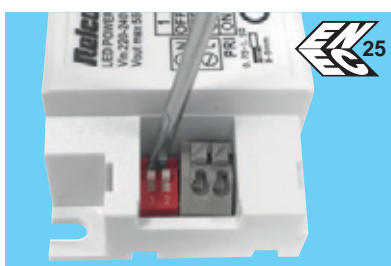

Fornito di dip switch per la selezione della corrente in uscita. Il driver incluso nel prodotto ha una taratura di fabbrica (vedere tabella). Se necessario è possibile diminuire la potenza nei modelli Ø600 e Ø800, nel modello Ø400 e' possibile diminuire o aumentare la potenza e di conseguenza i lumen output.

Equipped with dip switch for selecting the current output. The driver included inside the product have a driver standard factory setting (see table). If necessary, it is possible to decrease the power in the Ø600 and Ø800 models, in the Ø400 model it is possible to decrease or increase the power and consequently the lumen output.

### Mercedes Ø400

Taratura Dip-switch	Potenza Power	Lm Output
mA	Watt	Lm
500	20	1820
600	24	2184
650	27	2457
700	30	2730

Taratura standard di fabbrica  
Driver Standard factory setting

### Mercedes Ø600

Taratura Dip-switch	Potenza Power	Lm Output
mA	Watt	Lm
800	35	3185
900	38	3458
950	40	3640
1050	45	4095

Taratura standard di fabbrica  
Driver Standard factory setting

### Mercedes Ø800

Taratura Dip-switch	Potenza Power	Lm Output
mA	Watt	Lm
800	55	5000
900	65	5900
950	70	6370
1050	80	7280

Taratura standard di fabbrica  
Driver Standard factory setting

Versione C a plafone: accessori per montaggio a plafone inclusi.  
Ceiling C version: ceiling mounting accessories included.

**B** Bianco RAL9010 - di serie/ standard



**N** Nero RAL9005



**N** RAL 9005 - tempi di consegna 45 giorni - available in 45 days

Accessori sospensione non inclusi - Not included suspension accessories



Ceiling/suspended

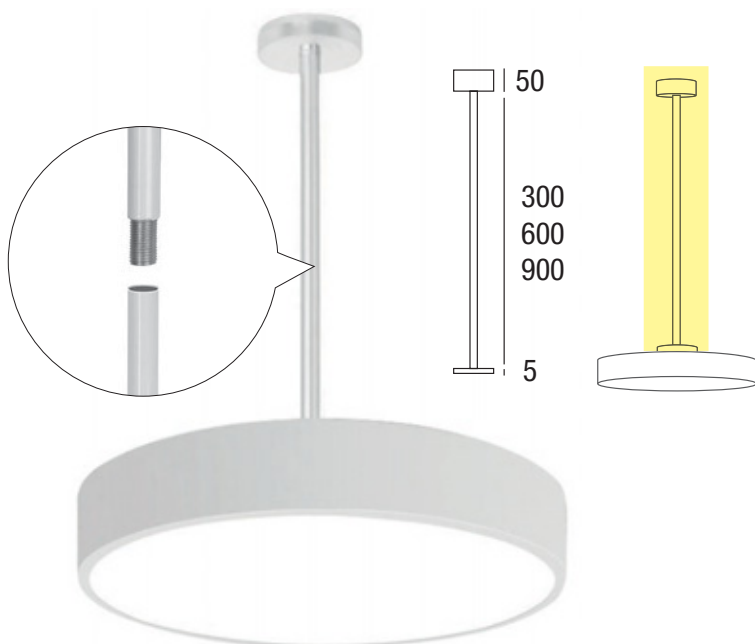

Cod. 6024-SR  
Ø400 - Ø600



Cod. 8024-SR  
Ø800



**Staffa rigida a richiesta**  
**Rigid ceiling staff on request**

Staffa rigida a plafone per Mercedes Ø400 Ø600 - Ø800 sezionabile in 3 moduli da 30 cm.

Ceiling mounted for Mercedes Ø400 - Ø600 Ø800 rigid bracket sectionable into 3 modules of 30 cm.





**Cod. 6024-S (400/800/600)  
Cod. 6024-S-1200**

**DALI 2 PUSH** Per versione Dali sostituire il cavo di alimentazione 3 poli con un cavo a 5 poli (non fornito).

*For Dali version replace the 3-pole power cable with a 5-pole cable (not supplied).*



**Cod. 6024-B-S (400/800/600)  
Cod. 6024-B-S-1200**

**DALI 2 PUSH** Per versione Dali sostituire il cavo di alimentazione 3 poli con un cavo a 5 poli (non fornito).

*For Dali version replace the 3-pole power cable with a 5-pole cable (not supplied).*

**MERCEDES VERSIONE **DALI 2****

Kit sospensione per LED Mercedes 40, 60, 80 e 120 va modificato utilizzando un cavo a 5 poli.

**MERCEDES DALI VERSION**

*Suspension kit for LED Mercedes 40, 60, 80 and 120 must be modified using a 5-pole cable.*

**Cod. 6024-5m-S**

Kit sospensione L.5 metri, per LED Mercedes 40, 60, 80 e 120 con cavo 2x0,75 Bianco H053N-F-2x0,75 e cavo in acciaio 2mm da 15m.

*Suspension kit L.5 meters, for LED Mercedes 40, 60, 80 and 120 with 2x0.75 White cable H053N-F-2x0.75 and 2mm 15m steel cable.*





Ceiling/suspended



**Piantana a LED dimmerabile a 3 step** ad emissione diretta e indiretta ad alta resa cromatica, per aree comuni, uffici, sale riunioni. Ideale in ambienti dove sia necessaria una luce diffusa perfettamente omogenea e per spazi di lavoro in cui è necessario un maggiore controllo dell'abbagliamento, grazie allo schermo diffusore microprismato, abbinato ad un film diffondente, consente un'ottimale diffusione della componente diretta della luce e un controllo della luminanza UGR<10.

I led per l'emissione down light e up light sono disposti nel perimetro.

**Installazione:** da terra. Il sistema è completo di cavi di alimentazione di lunghezza 2000 mm.

**Corpo e telaio:** profilo perimetrale in alluminio estruso anodizzato, verniciati con polvere termoidurente poliesteri.

**Verniciatura:** di tipo poliesteri eseguita a polvere. Colore bianco RAL 9010.

**Ottica:** diffondente. Composta da lastra in tecnopolimero (PMMA).

**Schermo:** schermo diffusore PMMA.

**UGR:** Conforme alla norma EN 12464-1 - ≤10.

**Temperatura colore:** standard 4000K.

**Conforme alla norma:** EN60598-1, RG0 nessun rischio fotobiologico ai fini della norma EN62471.

**Led:** mantenimento del flusso luminoso minimo al 80%: 50.000h (L80B10).

**Driver:** multipotenza . Fattore di potenza ≥0,95.

**3 Step dimmable LED floor lamp** with direct and indirect emission with high colour rendering, for public areas, offices, meeting rooms. Ideal for rooms requiring perfectly evenly diffused light and for workspaces which need greater glare control, thanks to the microprismatic diffuser screen, coupled to an internal diffuser film screen, for optimal diffusion of the direct light component and luminance control UGR<10.

LEDs for down light and up light emission are set up in the perimeter.

**Installation:** on floor. The system includes 2000 mm long power cables.

**Body and frame:** perimeter profile in anodised extruded aluminium, coated with thermosetting polyester powder.

**Painting:** powder polyester coating. White RAL 9010.

**Optics:** diffusing. Consisting of techno-polymer sheet (PMMA).

**Screen:** PMMA diffuser screen.

**UGR:** Complies with standard EN 12464-1 - ≤10.

**Colour temperature:** standard 4000K.

**Compliant with standard:** EN60598-1, RG0 no photobiological risk for the purposes mentioned in standard EN62471.

**LED:** maintenance of 80% minimum luminous flux: 50,000h (L80B10).

**Driver:** multipower . Power factor ≥0.95.

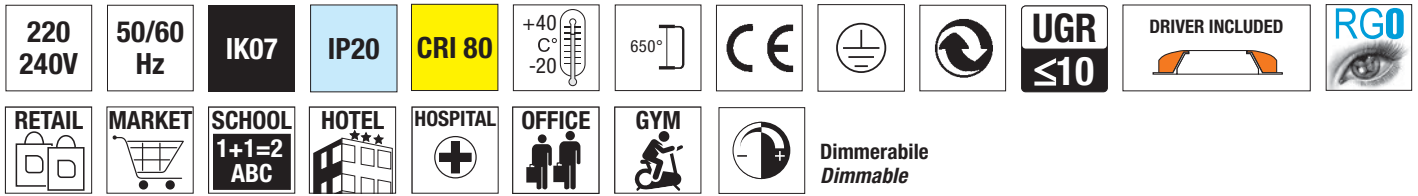

**LED Mercedes floor Up & Down**



Tastierino push 3 STEP per la regolazione della luminosità.  
3 STEP push keypad for brightness adjustment.

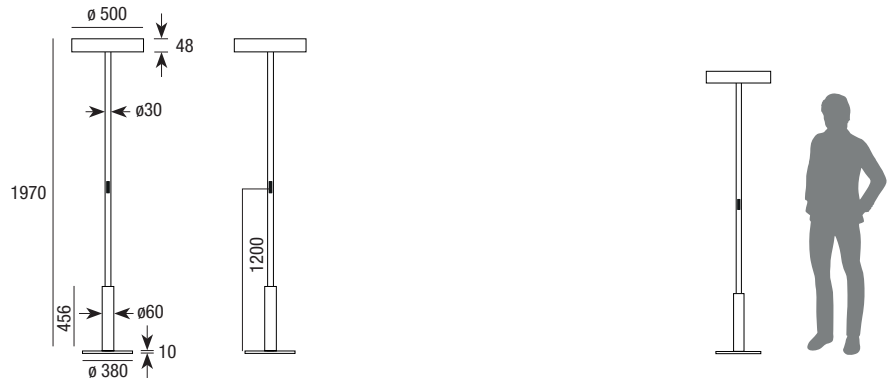

colour	W max	Lm output	lm/W	K	pcs	Kg	CELL
B	↑ 40 ↓ 40	↑ 4800 ↓ 4800	120	4000	001	13,9	RLRF1904506

**Dati fotometrici  
Photometric data**

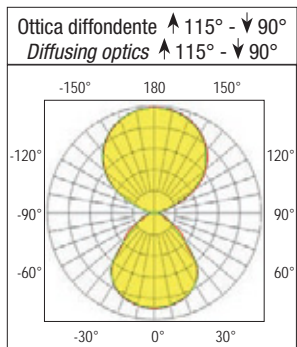

Floor up & down

## LED Zante Floor Up & Down



**Piantana a LED dimmerabile** ad emissione diretta e indiretta neutral white 4000K ad alta resa cromatica, per aree comuni, uffici, sale riunioni, negozi. Ideale in ambienti dove sia necessaria una luce diffusa perfettamente omogenea e per spazi di lavoro in cui è necessario un maggiore controllo dell'abbagliamento, grazie allo schermo diffusore microprismato, abbinato ad uno schermo interno e ad un film diffondente, consente un'ottimale diffusione della componente diretta della luce e un controllo della luminanza UGR<19.

I led per l'emissione down light e up light sono disposti nel perimetro.

**Installazione:** da terra. Il sistema è completo di cavi di alimentazione di lunghezza 2000 mm.

**Corpo e telaio:** profilo perimetrale in alluminio estruso anodizzato, verniciati con polvere termoindurente poliesteri.

**Verniciatura:** di tipo poliesteri eseguita a polvere. Colore bianco RAL 9010.

**Ottica:** diffondente. Composta da lastra in tecnopolimero (PMMA).

**Schermo:** schermo diffusore microprismato.

**UGR:** Conforme alla norma EN 12464-1 -  $\leq 19$ .

**Temperatura colore:** standard 4000K.

**Conforme alla norma:** EN60598-1, RG0 nessun rischio fotobiologico ai fini della norma EN62471.

**Led:** mantenimento del flusso luminoso minimo al 80%: 50.000h (L80B10).

**Driver:** multipotenza . Fattore di potenza  $\geq 0,95$ .

*Dimmable LED floor lamp with direct and indirect emission, neutral white 4000K with high colour rendering, for public areas, offices, meeting rooms, shops. Ideal for rooms requiring perfectly evenly diffused light and for workspaces which need greater glare control, thanks to the micro-prismatic diffuser screen, coupled to an internal diffuser film screen, for optimal diffusion of the direct light component and luminance control UGR<19.*

*LEDs for down light and up light emission are set up in the perimeter.*

**Installation:** on floor. The system includes 2000 mm long power cables.

**Body and frame:** perimeter profile in anodised extruded aluminium, coated with thermosetting polyester powder.

**Painting:** powder polyester coating. White RAL 9010.

**Optics:** diffusing. Consisting of techno-polymer sheet (PMMA).

**Screen:** microprismatic diffuser screen.

**UGR:** Complies with standard EN 12464-1 -  $\leq 19$ .

**Colour temperature:** standard 4000K.

**Compliant with standard:** EN60598-1, RG0 no photobiological risk for the purposes mentioned in standard EN62471.

**LED:** maintenance of 80% minimum luminous flux: 50,000h (L80B10).

**Driver:** multipower . Power factor  $\geq 0.95$ .

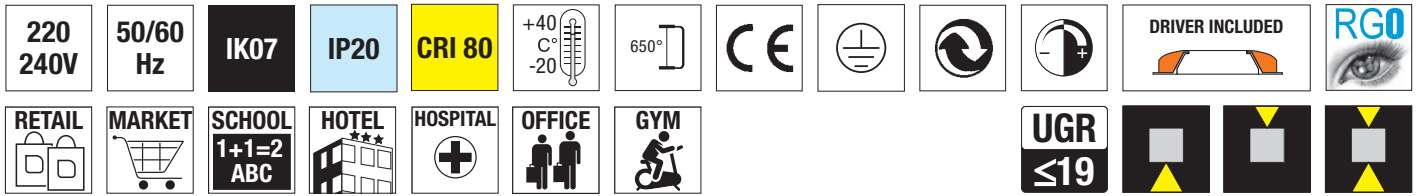

**LED Zante Floor Up & Down**



colour	W max	Lm output	lm/W	K	pcs	Kg	CELL
[B]	55	max 6.600	120	4000	001	13,9	25930/FLOOR

**Dati fotometrici  
Photometric data**

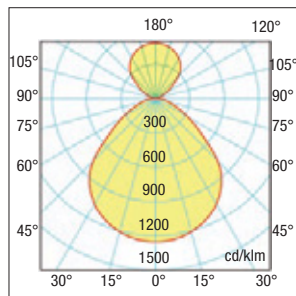

*illuminazione solo sotto  
Lighting only below*



*illuminazione solo sopra  
Lighting only above*



*illuminazione sopra e sotto  
Lighting above and below*



**Floor up & down**



**Piantana a LED dimmerabile a 3 step** ad emissione indiretta ad alta resa cromatica, per aree comuni, uffici, sale riunioni, negozi. Ideale in ambienti dove sia necessaria una luce diffusa perfettamente omogenea.

**Installazione:** da terra.

Il sistema è completo di cavi di alimentazione di lunghezza 2000 mm.

**Corpo e telaio:** profilo perimetrale in alluminio estruso anodizzato, verniciati con polvere termoindurente poliestere.

**Verniciatura:** di tipo poliestere eseguita a polvere. Colore bianco RAL 9010.

**Ottica:** diffondente.

**Schermo:** schermo diffusore microprismato.

**UGR:** Conforme alla norma EN 12464-1 -  $\leq 10$ .

**Temperatura colore:** 3000K.

**Conforme alla norma:** EN60598-1, RG0 nessun rischio fotobiologico ai fini della norma EN62471.

**Led:** mantenimento del flusso luminoso minimo al 80%: 50.000h (L80B10).

**Driver:** multipotenza . Fattore di potenza  $\geq 0,95$ .

**3 step dimmable LED floor lamp** with indirect emission with high colour rendering, for public areas, offices, meeting rooms, shops. Ideal for rooms requiring perfectly evenly diffused light.

LEDs for down light and up light emission are set up in the perimeter.

**Installation:** on floor. The system includes 2000 mm long power cables.

**Body and frame:** perimeter profile in anodised extruded aluminium, coated with thermosetting polyester powder.

**Painting:** powder polyester coating. White RAL 9010.

**Optics:** diffusing.

**Screen:** microprismatic diffuser screen.

**UGR:** Complies with standard EN 12464-1 -  $\leq 10$ .

**Colour temperature:** 3000K.

**Compliant with standard:** EN60598-1, RG0 no photobiological risk for the purposes mentioned in standard EN62471.

**LED:** maintenance of 80% minimum luminous flux: 50,000h (L80B10).

**Driver:** multipower . Power factor  $\geq 0.95$ .



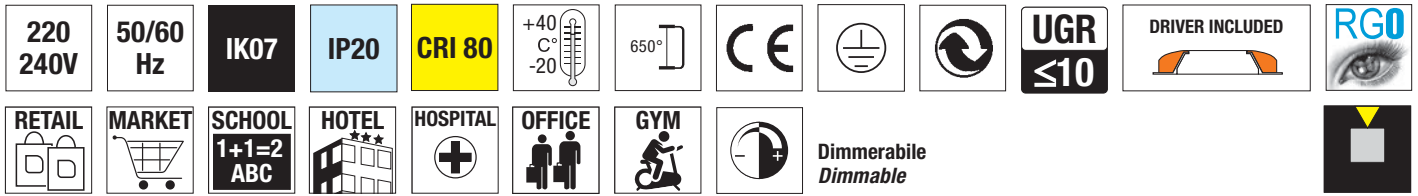

**LED Giorgia Floor Up**



Tastierino push  
3 STEP per la  
regolazione della  
luminosità.  
3 STEP push  
keypad for  
brightness  
adjustment.

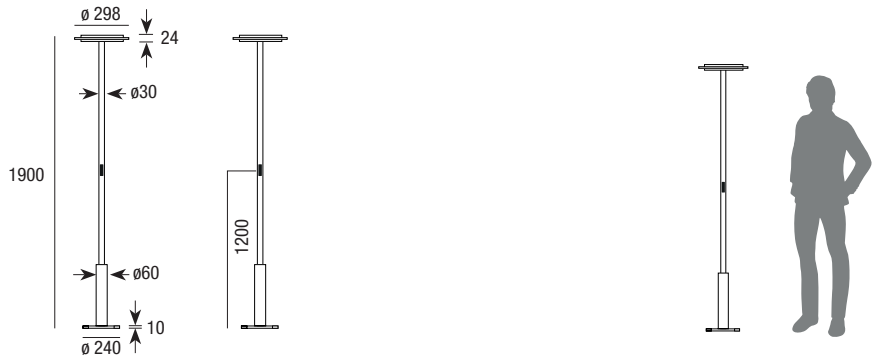

colour	W max	Lm output	lm/W	K	pcs	Kg	CELL
B	45	max 5.400	120	3000	001	13,9	RLSF1904506

**Dati fotometrici  
Photometric data**

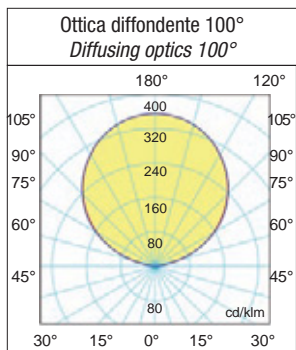

Floor up & down

## LED Unica S-C

Apparecchio singolo e fila continua  
*Single devices and continuous line*

A RICHIESTA  
ON DEMAND

0-10V



È un oggetto brillante che valorizza gli ambienti di lavoro e di comunicazione sia con l'effetto di luce che con l'estetica. Ideale per lavorare ma anche per rilassarsi e disporre sempre di un'atmosfera piacevole.

LED Unica è decisamente versatile nell'impiego: uffici, istituti scolastici sono le due applicazioni più tipiche in cui si rivela la soluzione ideale per economicità e non solo in termini di luce ma anche di manutenzione.

**Installazione:** sospensione (accessori non inclusi), plafone (con accessori di montaggio inclusi).

**Corpo e telaio:** struttura in lamiera di acciaio.

**Verniciatura:** di tipo poliestere eseguita a polvere. Colore bianco RAL 9010.

**Diffusore:** lastra in policarbonato diffondente.

**Schermo:** in policarbonato opale di spessore 2mm.

**Temperatura colore:** 3000 e 4000K.

**Led:** mantenimento del flusso luminoso minimo al 80%: 50.000h (L80B10).

**Driver:** conforme alle norme EN55015, EN6100-3-2, EN6100-3-3, EN61347-1, EN61347-2-13, EN61547, EN62384.

Fattore di potenza  $\geq 0,95$ .

Prodotto conforme alle direttive:

*it is a brilliant object that enhances work and communication environments both with the light effect and with the aesthetics. Ideal for working but also for relaxing and always having a pleasant atmosphere.*

*LED Unica is decidedly versatile in its use: offices and schools are the two most typical applications in which it proves to be the ideal solution in terms of economy and not only in terms of light but also in terms of maintenance.*

**Installation:** Suspension (accessories not included) or ceiling (with included assembly accessories).

**Body and frame:** structure in sheet steel.

**Coating:** powder polyester coating. White RAL 9010.

**Diffuser:** sheet in diffusing polycarbonate.

**Shield:** in 2mm thick opal polycarbonate.

**Color temperature:** 3000K or 4000K.

**Led:** maintenance of 80% minimum luminous flux: 50,000h (L80B10).

**Driver:** compliant with standards EN55015, EN6100-3-2, EN6100-3-3, EN61347-1, EN61347-2-13, EN61547, EN62384.

Power factor  $\geq 0,95$ .

Product compliant with directives:

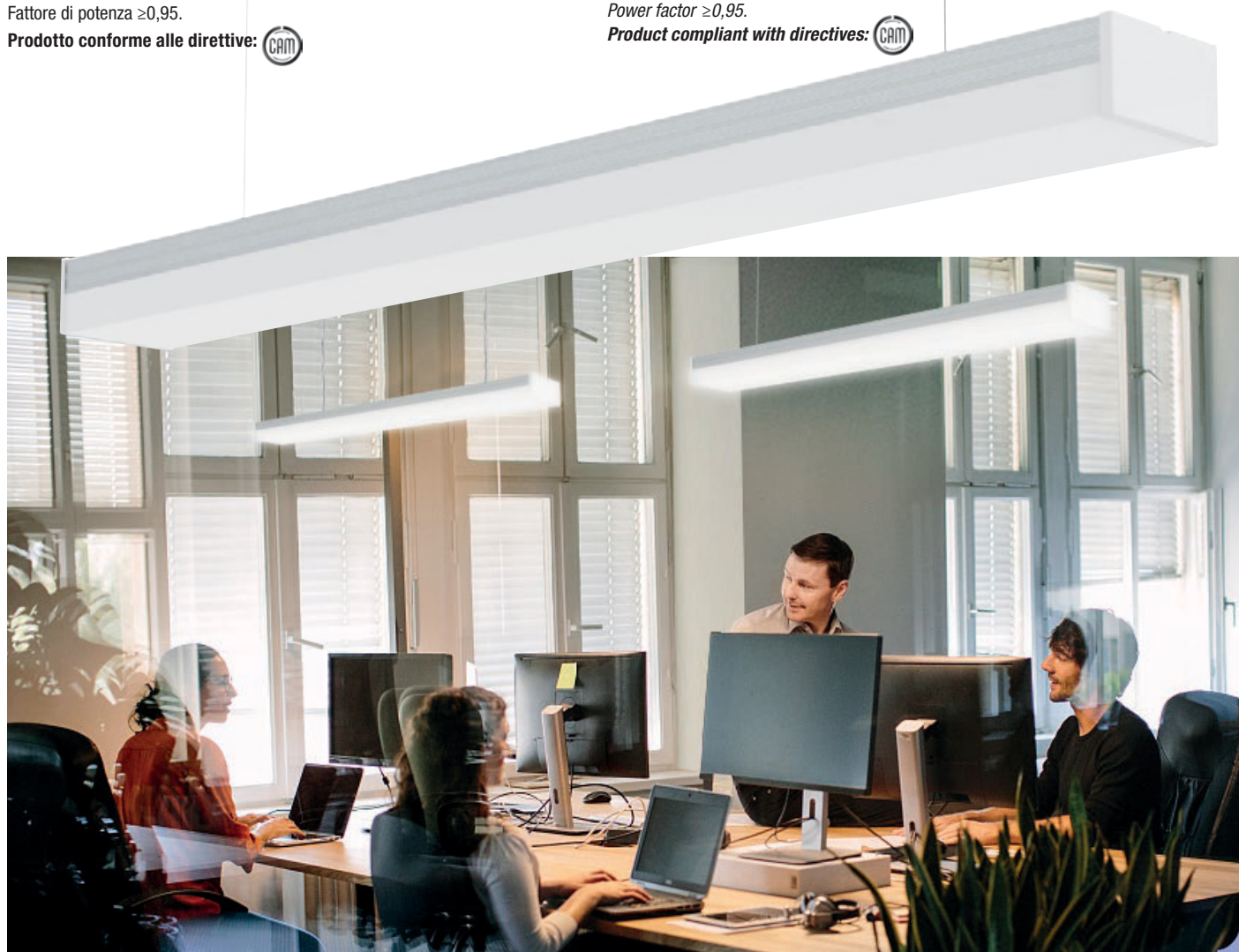

### Accessori non inclusi - Accessoires not included

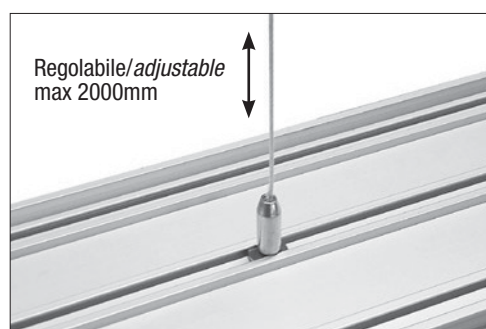

#### Cod.6024-S

Cavi per sospensione comprensivi di rosoni, saliscendi viti e tasselli.

*Suspension cables including rosettes, latch screws and plugs.*

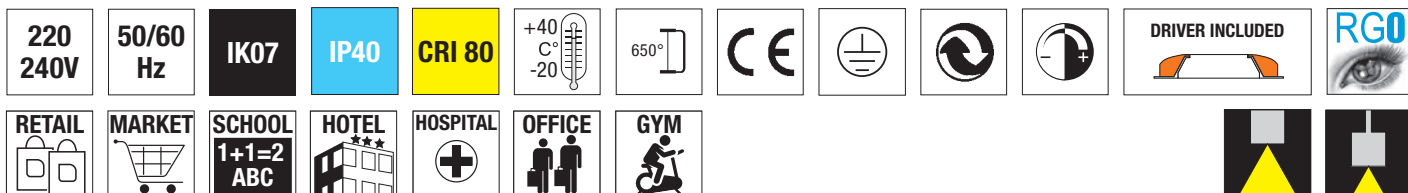

**LED Unica**

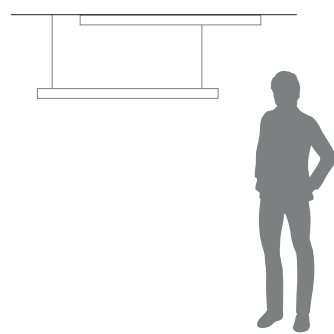
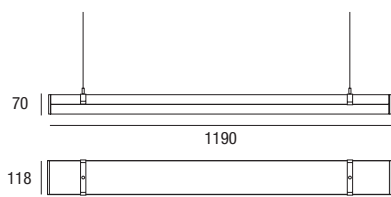

**Dati fotometrici  
Photometric data**

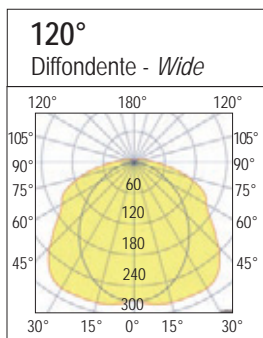

colour	W max	Vac	lm output	lm/W	K	pcs	Kg	CELL
B	24	220-240	2400	100	4000	001	4.50	6025-24
B	36	220-240	3600	100	4000	001	4.50	6025-36
B	48	220-240	4800	100	4000	001	4.50	6025-48
<b>DALI 2</b>	B	24	220-240	2400	100	4000	4.50	6025-24DA
<b>DALI 2</b>	B	36	220-240	3600	100	4000	4.50	6025-36DA
<b>DALI 2</b>	B	48	220-240	4800	100	4000	4.50	6025-48DA
B	24	220-240	2400	100	3000	001	4.50	6025-243K
B	36	220-240	3600	100	3000	001	4.50	6025-363K
B	48	220-240	4800	100	3000	001	4.50	6025-483K
<b>DALI 2</b>	B	24	220-240	2400	100	3000	4.50	6025-243KDA
<b>DALI 2</b>	B	36	220-240	3600	100	3000	4.50	6025-363KDA
<b>DALI 2</b>	B	48	220-240	4800	100	3000	4.50	6025-483KDA

Applicazione a soffitto o sospensione in linea continua, con collegamento in parallelo  
*Ceiling or suspension application continuous row, with parallel connection*

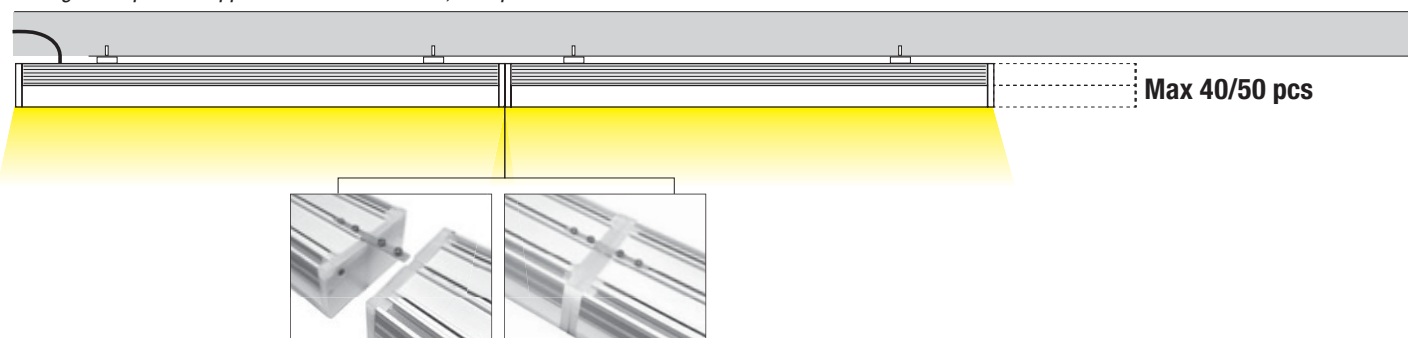

**Accessori inclusi - Accessoires included**

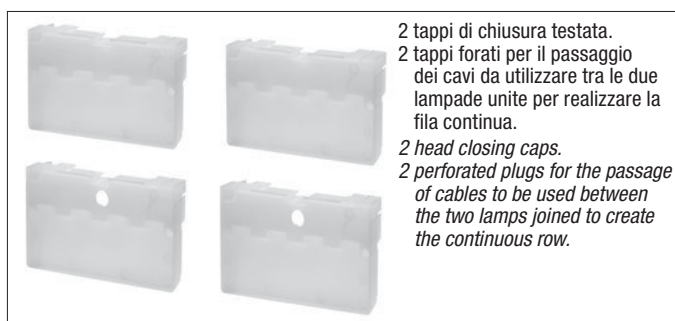

## Syros slim system S-C

Apparecchio singolo e fila continua  
Single devices and continuous line

A RICHIESTA  
ON DEMAND

WIRELESS

0-10V

DALI 2

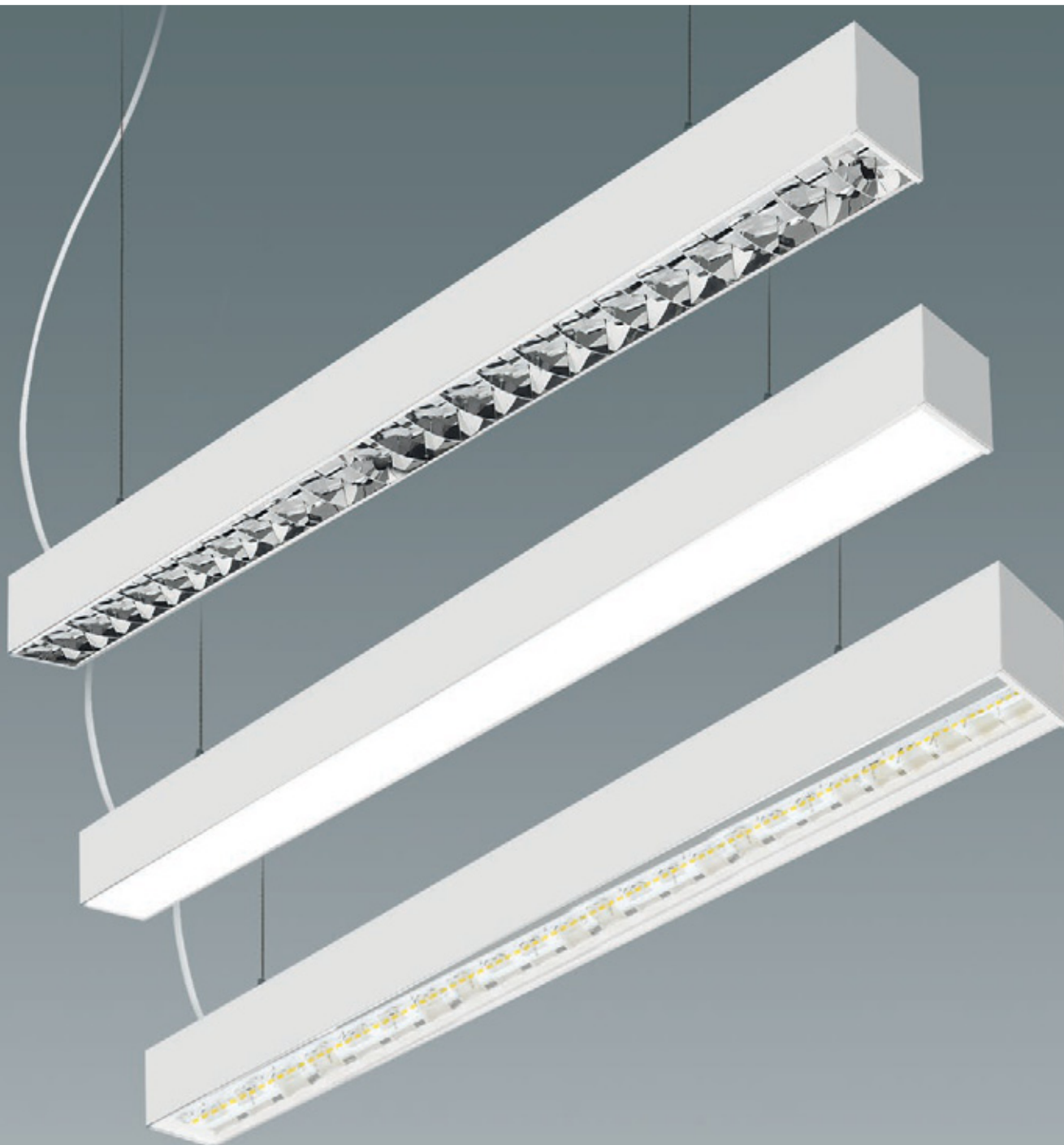

### LED Syros slim S-C dark light, opale, asimmetrica.

Sistema luminoso modulare per file continue a sospensione o a plafone in versione dark light, opale o con lenti, uffici, reception, supermarket, palestre. Elementi di giunzione di semplice utilizzo per linee continue o accessorio per angoli a 90° a T e X non luminosi. Collegamento rapido con morsetto fast. Modulo cieco a richiesta predisposto per linea passante DALI, 0-10V. ed emergenza.

**Installazione:** a sospensione o a plafone.

**Corpo:** alluminio estruso anodizzato al naturale verniciato a polveri epossidiche bianco RAL 9010 e nero RAL 9005.

**Ottica dark Light:** parabola in alluminio 99,85, antiriflesso UGR<16 e antiridescente a bassissima luminanza.

**Ottica opale:** in policarbonato ad incastro a filo, UGR<19.

**Ottica asimmetrica e bi-asimmetrica:** in PMMA schermo trasparente.

**Conforme alla norma:** EN60598-1, RG0 nessun rischio fotobiologico ai fini della norma EN62471.

**Led:** Samsung SMD mantenimento del flusso luminoso minimo al 80%: 50.000h (L80B10).

**Driver multipotenza:** Incluso > 50.000 h  Fattore di potenza ≥0,95.

**A richiesta:** per quantità si esegue il settaggio dedicato della corrente del Driver e di conseguenza la potenza di W e Lm.

Prodotto conforme alle direttive: 

### LED Syros slim S-C dark light, opal, asymmetrical.

Modular light system for continuous rows, suspension or ceiling, in dark light version, opal or with lenses, for offices, receptions, supermarkets, gyms. Easy to use joining elements for continuous lines or non-luminous T- and X-shaped 90° angle accessory. Quick connection with fast clamp. Dummy model on demand designed for DALI feedthrough line, 0-10V. and emergency.

**Installation:** suspension or ceiling.

**Body:** natural anodised extruded aluminium painted with white RAL 9010 and black RAL 9005 epoxy powders.

**Dark light optics:** 99.85 aluminium parabola, antiglare UGR<16 and anti-iridescent, with very low luminance.

**Opal optics:** in flush joint polycarbonate, UGR<19.

**Asymmetric and bi-asymmetric optics:** in PMMA transparent screen.

**Compliant with standard:** : EN60598-1, RG0 no photobiological risk for the purposes mentioned in standard EN62471.

**Led:** Samsung SMD maintenance of 80% minimum luminous flux: 50,000h (L80B10).

**Driver multipower:** Included > 50,000 h  Power factor ≥0.95.

**On request:** for quantity, the dedicated setting of the Driver current and consequently the power of W and Lm is carried out.

Product compliant with directives: 

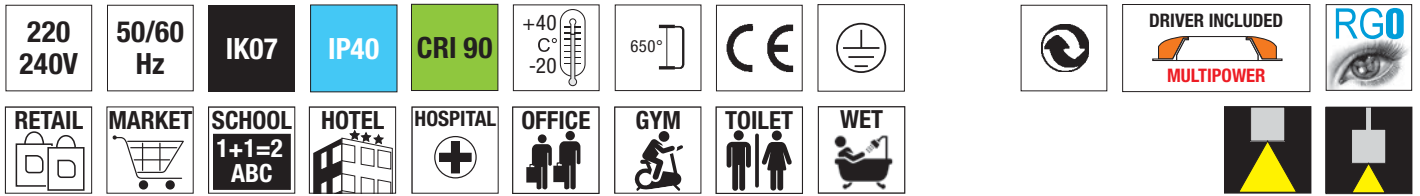

**Syros slim system S-C Dark light**

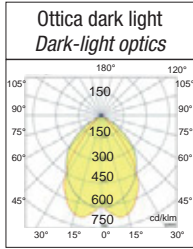
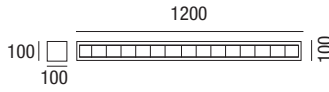

	colour	W max	Vac	lm output	lm/W	K	pcs/pallets	Kg	CELL
	B	40	220-240	5200	130	4000	60	4.50	25936/SL/SCDL
	N	40	220-240	5200	130	4000	60	4.50	25936SLSCDL/B
	0-10V	B	40	220-240	5200	130	60	4.50	25936SLSCDLDI
	DALI 2	B	40	220-240	5200	130	60	4.50	25936SLSCDLDA
	DALI 2	N	40	220-240	5200	130	60	4.50	25936SCDLDA/B
	B	60	220-240	7800	130	4000	60	4.50	25938/SL/SCDL
	N	60	220-240	7800	130	4000	60	4.50	25938SLSCDL/B
	0-10V	B	60	220-240	7800	130	60	4.50	25938SLSCDLDI
	DALI 2	B	60	220-240	7800	130	60	4.50	25938SLSCDLDA
	DALI 2	N	60	220-240	7800	130	60	4.50	25938SCDLDA/B

**85 W - 11.000 lm** A richiesta per quantità - *On request for quantity*

**EMER** Per lampade cablate in emergenza (aggiungere /EM dopo il codice) sovrapprezzo del 30%.  
**For wired emergency lights (add /EM after the code) 30% extra charge.**

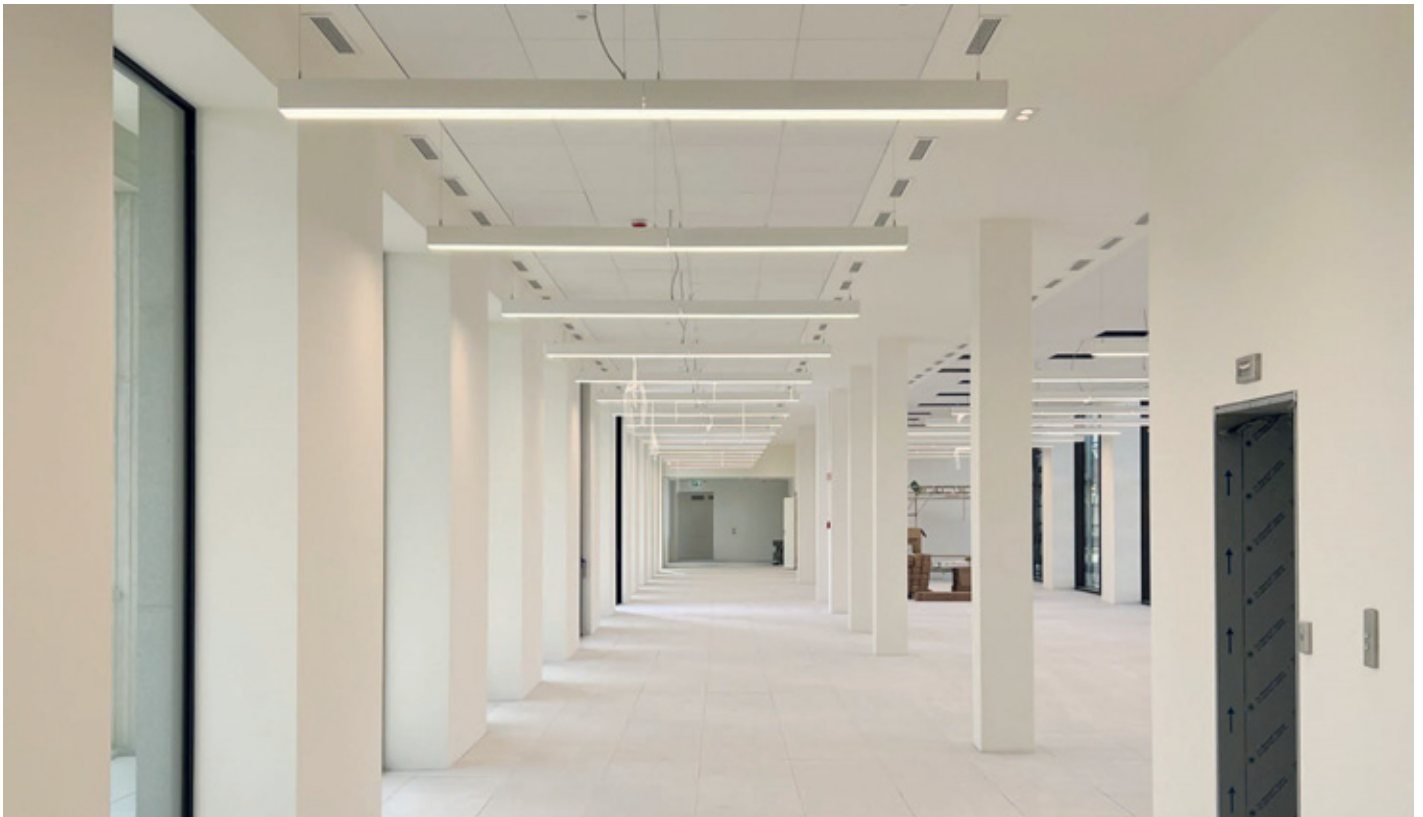

Ceiling/suspended

## Installazione a sospensione Suspension installation



### Installazione a sospensione con doppia accensione Suspended installation with double ignition

#### kit sospensione (non incluso)

Con l'aggiunta di kit sospensione è possibile decidere l'altezza della lampada con facilità agendo direttamente sul pulsante si può aumentare o diminuire il cavo fino ad un max di 1500mm.

**suspension kit (not included)**  
*With the addition of the suspension kit, you can easily decide the height of the lamp by acting directly on the button, you can increase or decrease the cable up to a maximum of 1500mm.*

A richiesta  
On request

#### Doppia emissione Double emission

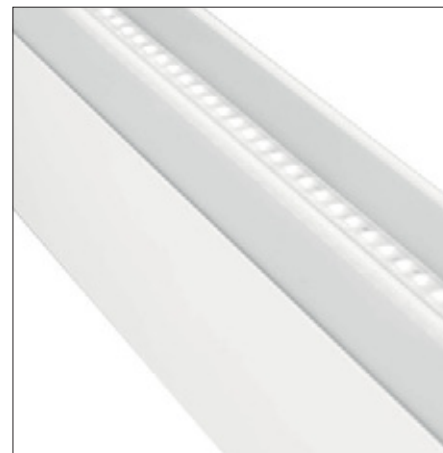
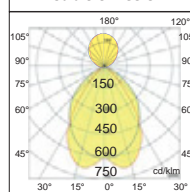

Luce indiretta 960 lm con doppia accensione, sovrapprezzo del 40%.  
(aggiungere /DM dopo il codice).  
*Indirect light 960 lm with double switch-on, 40% extra charge.  
(add /DM after the code).*

# Syros slim system S-C

## Syros slim system S-C Opal

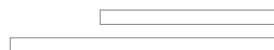
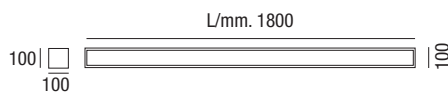
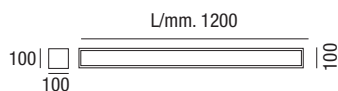

colour	W max	Vac	lm output	lm/W	K	L [mm]	pcs/pallets	Kg	CELL
B	40	220-240	5000	125	4000	1200	60	4.50	25940/SL/SCOP
N	40	220-240	5000	125	4000	1200	60	4.50	25940SLSCOPBL
0-10V	B	40	220-240	5000	125	4000	1200	60	25940SLSCOPDI
DALI 2	B	40	220-240	5000	125	4000	1200	60	25940SLSCOPDA
DALI 2	N	40	220-240	5000	125	4000	1200	60	25940SCOPDABL
B	60	220-240	7500	125	4000	1200	60	4.50	25942/SL/SCOP
N	60	220-240	7500	125	4000	1200	60	4.50	25942SLSCOP/B
0-10V	B	60	220-240	7500	125	4000	1200	60	25942SLSCOPDI
DALI 2	B	60	220-240	7500	125	4000	1200	60	25942SLSCOPDA
DALI 2	N	60	220-240	7500	125	4000	1200	60	25942SCOPDA/B
colour	W max	Vac	lm output	lm/W	K	L [mm]	pcs/pallets	Kg	CELL
B	85	220-240	11.000	129	4000	1800	60	5.00	25947/SL/SCOP
N	85	220-240	11.000	129	4000	1800	60	5.00	25947SLSCOPBL
0-10V	B	85	220-240	11.000	129	4000	1800	60	25948SLSCOPDI
DALI 2	B	85	220-240	11.000	129	4000	1800	60	25949LSCOPDA
DALI 2	N	85	220-240	11.000	129	4000	1800	60	25949SCOPDA/B

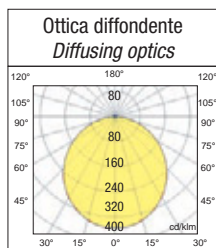

**EMER** Per lampade cablate in emergenza (aggiungere /EM dopo il codice) sovrapprezzo del 30%.  
For wired emergency lights (add /EM after the code) 30% extra charge.

## Installazione a plafone con accessori inclusi Ceiling installation with included accessories



Ceiling/suspended

# Syros slim system S-C



Ceiling/suspended

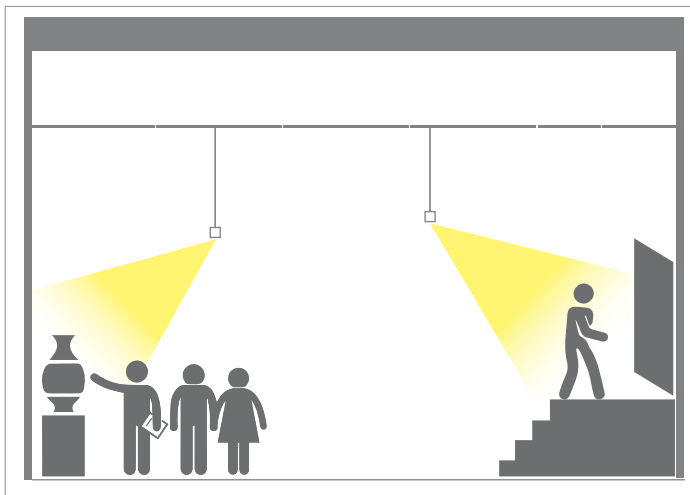

## Ottica asimmetrica

Ideale per l'illuminazione di pareti in modo uniforme.

## Asymmetric optics

Ideal for evenly lighting walls.

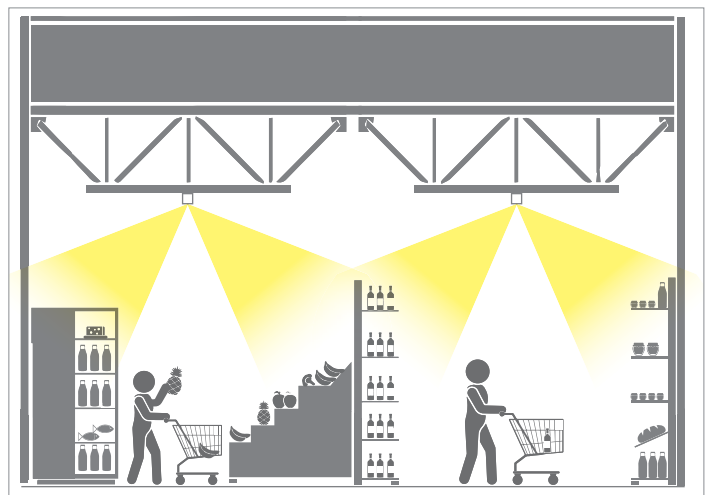

## Ottica bi-asimmetrica

Adatta per gli spazi commerciali al fine di dare maggior risalto alla merce esposta rispetto alle corsie.

## Bi-asymmetric optics

Suitable for sales spaces to allow the displayed goods to stand out respect to the lanes.



# Syros slim system S-C

## Syros slim system S-C asimmetrica

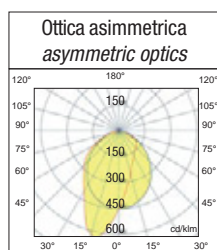
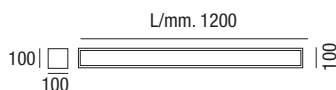

	colour	W max	Vac	lm output	lm/W	K	pcs/pallets	Kg	CELL
	B	40	220-240	5200	130	4000	60	4.50	25943/SL/SCWW
	<b>0-10V</b>	B	40	220-240	5200	130	4000	4.50	25943SLSCWWDI
	<b>DALI 2</b>	B	40	220-240	5200	130	4000	4.50	25943SLSCWWDA
	B	60	220-240	7800	130	4000	60	4.50	25944/SL/SCWW
	<b>0-10V</b>	B	60	220-240	7800	130	4000	4.50	25944SLSCWWDI
	<b>DALI 2</b>	B	60	220-240	7800	130	4000	4.50	25944SLSCWWDA

**EMER** Per lampade cablate in emergenza (aggiungere /EM dopo il codice) sovrapprezzo del 30%.  
For wired emergency lights (add /EM after the code) 30% extra charge.

## 3S Syros slim system bi-asimmetrica

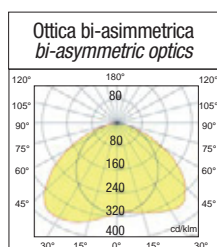
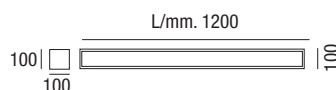

	colour	W max	Vac	lm output	lm/W	K	pcs/pallets	Kg	CELL
	B	40	220-240	5200	130	4000	60	4.50	25945/SL/SC2A
	<b>0-10V</b>	B	40	220-240	5200	130	4000	4.50	25945SLSC2ADI
	<b>DALI 2</b>	B	40	220-240	5200	130	4000	4.50	25945SLSC2ADA
	B	60	220-240	7800	130	4000	60	4.50	25946/SL/SC2A
	<b>0-10V</b>	B	60	220-240	7800	130	4000	4.50	25946SLSC2ADI
	<b>DALI 2</b>	B	60	220-240	7800	130	4000	4.50	25946SLSC2ADA

**EMER** Per lampade cablate in emergenza (aggiungere /EM dopo il codice) sovrapprezzo del 30%.  
For wired emergency lights (add /EM after the code) 30% extra charge.

# Syros slim system accessori - accessories

Serie di accessori che consentono il fissaggio in linea della famiglia Syros Slim.  
 Series of accessories that allow the Syros Slim family to be fixed in line.

## Accessori a richiesta - Accessoires on demand

**Modulo cieco** - predisposto con cablaggio per linee passanti e DALI o 0-10V. + EMERGENZA.

**Non-luminous pipe** - set up with wiring for through- and DALI or 0-10V lines. + EMERGENCY.

Colour		pcs	Kg	Code	
B	7 FILI/WIRE	1.200	001	3,80	25940/SL/SC

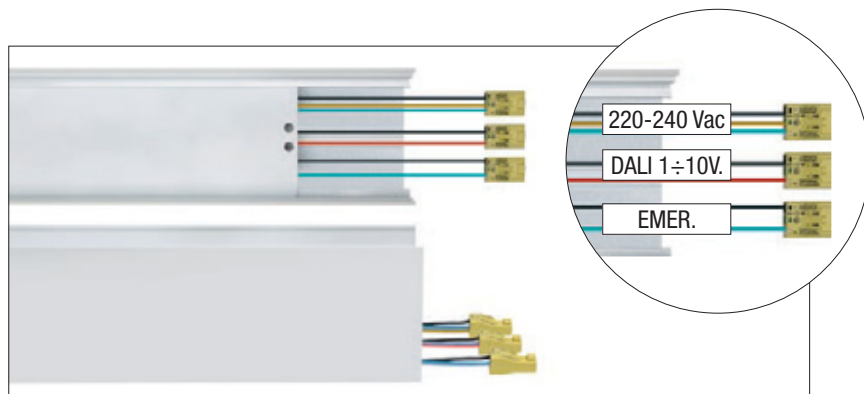
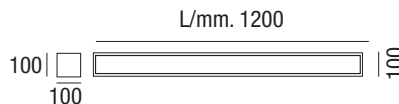

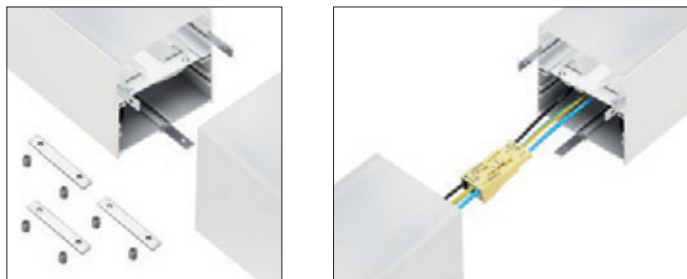

## Staffe di giunzione (KIT 3 pezzi) - Junction brackets (Kit 3 pieces)

Colour	pcs	Kg	Code
B	1	0,01	25803/SL



## Kit di alimentazione - Power supply kit

Colour	Cavo	pcs	Kg	Code
B	3x1,5	1	0,01	102/3/C
B	5x1,5	 1	0,01	102/5/C
N	3x1,5	1	0,01	102B/3/C
N	5x1,5	 1	0,01	102B/5/C

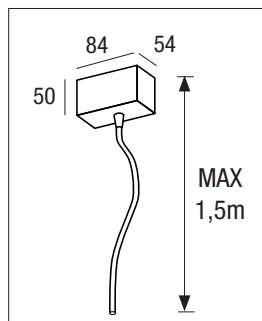

## Cavo per sospensione - Suspension cable

pcs	Kg	PCS	Code
001	0,250	1 cavi/cables	103/S

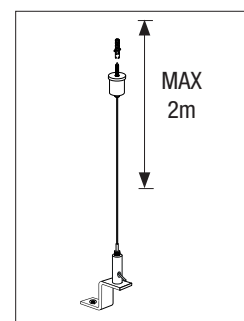
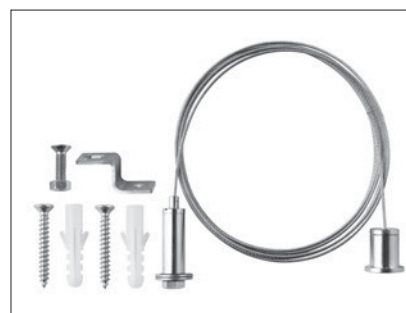

# Syros slim system accessori - accessories

## Giunto angolare a L - T - X con 4 tappi chiusura L - T - X-shaped corner joint with 4 closure caps

Colour	pcs	Kg	Code
<b>B</b>	1	0,20	25802/SL

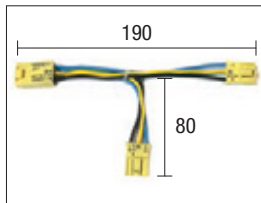
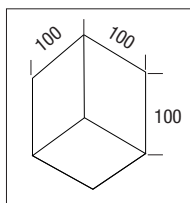
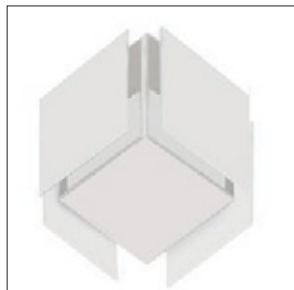

**Cod. 49002511**  
Accessorio connessione  
**T** ordinare 1 pz, **X** ordinare 2 pz.  
Accessory connection  
**T** order 1 pc, **X** order 2 pcs.



Soluzioni NON incluse per aumentare il risparmio energetico  
Solutions NOT included to increase energy saving

## Giunto angolare a L - T - X con rilevatore di presenza ad infrarossi, telecomando e 4 tappi chiusura L - T - X angular joint with infrared presence detector, remote control and 4 closure caps

Colour	pcs	Kg	Code
<b>0-10V</b> <b>B</b>	1	0,87	HIR22/SYROS/DI
<b>DALI</b> <b>B</b>	1	0,87	HIR23/SYROS/DA

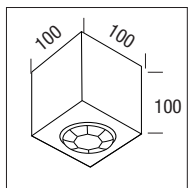

### Ampiezza rilevamento Detection width

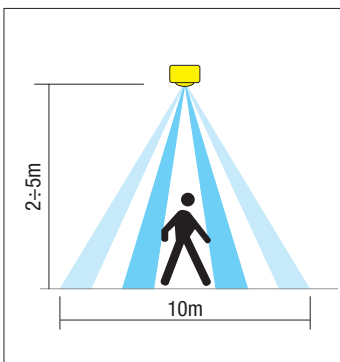

**HIR22/SYROS/DI** **DIM 1-10V**

Angolo di rivelamento Detection angle	360°
Altezza di montaggio Assembly height	2÷5 metri
Ampiezza rilevamento Detection Width	Ø 10m
Assorbimento stand by Stand-by absorption	<0,5W

**HIR23/SYROS/DA** **DALI**

Angolo di rivelamento Detection angle	360°
Altezza di montaggio Assembly height	2÷5 metri
Ampiezza rilevamento Detection Width	Ø 10m
Assorbimento stand by Stand-by absorption	<0,5W Max 64 Driver conforme allo standard DALI <0,5W Max 64 drivers compliant with DALI standard

**Cod. HRC-11**

#### Accessorio NON incluso

L'utilizzo del telecomando HRC-11 permette di modificare le impostazioni senza dover accedere direttamente al trimmer integrato

#### NOT included accessory

Using the HRC-11 remote control allows you to change settings without needing to directly access the built-in trimmer.



# Syros slim sospensione, esempio applicativo

## Syros slim suspension, application example

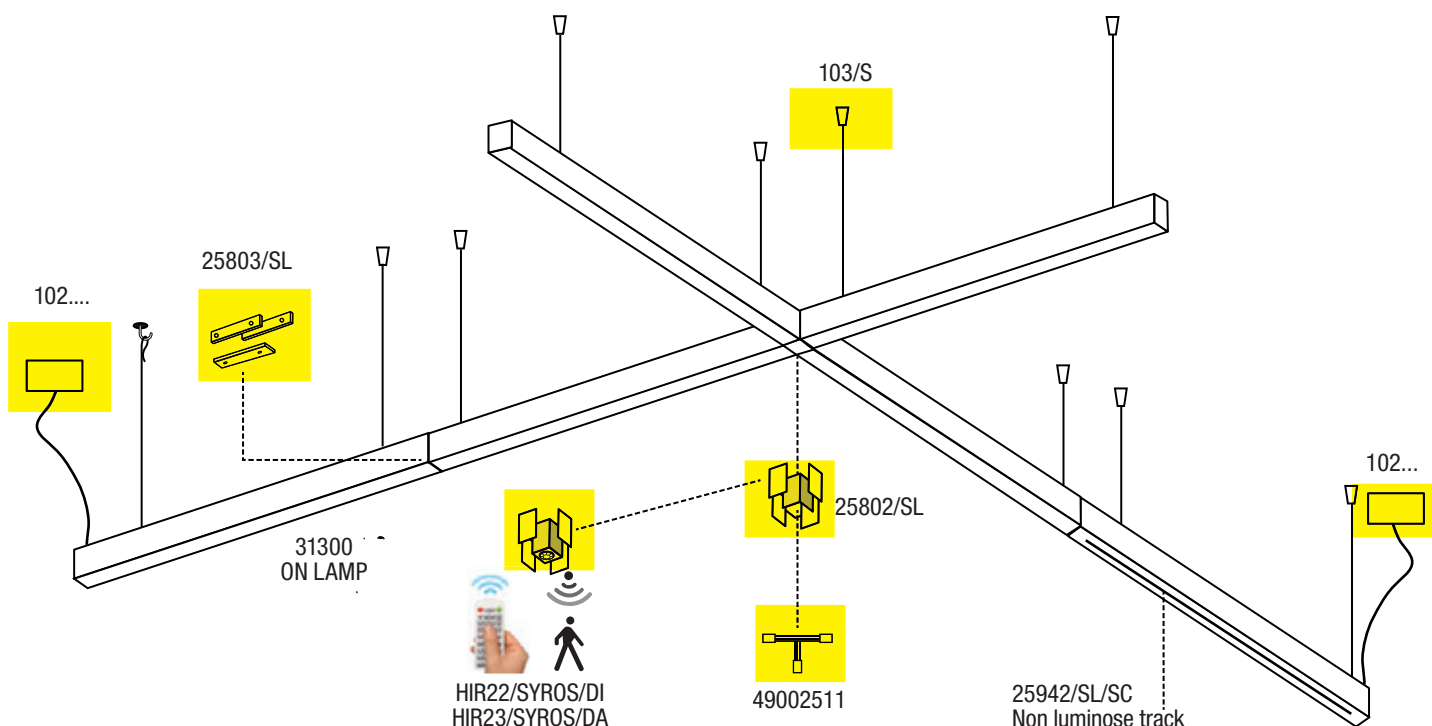

## Syros Slim Emergenza Autotest

### Apparecchi di illuminazione cablati in emergenza

Relco nella politica di offrire un servizio migliore alla clientela, ha deciso di utilizzare nei suoi apparecchi di illuminazione dotati di emergenza, solo INVERTER PER EMERGENZA CON AUTOTEST.

### Emergency wired luminaires

Relco in its policy of offering a better service to customers, has decided to use only EMERGENCY INVERTER WITH SELF-TEST in its luminaires equipped with emergency.

Le norme europee EN 1838, EN 60598-2-22, relative ai sistemi di illuminazione di emergenza, impongono che periodicamente, siano effettuati dei test per verificare sia il funzionamento sia l'efficienza (durata in emergenza) degli apparecchi di illuminazione che svolgono anche la funzione di illuminazione di emergenza. Questo costringe i manutentori dell'impianto ad interrompere la linea di alimentazione ed effettuare test con cadenza settimanale (test funzionale), e con cadenza trimestrale o annuale (test di autonomia).

Con i nostri kit di emergenza con autotest (conformi alla normativa europea EN 62034) queste prove vengono svolte automaticamente con cadenza programmabile in fase di installazione. Inoltre il nostro inverter analizza i tempi di normale accensione e spegnimento dell'apparecchio ed effettua (qualora possibile) i test nelle ore di assenza delle persone.

Eventuali anomalie sono segnalate tramite un indicatore (led) rosso verde.

A partire dal colore della segnalazione è possibile stabilire in maniera univoca gli eventuali problemi di funzionamento come evidenziato nella tabella seguente.

The European standards EN 1838, EN 60598-2-22, relating to emergency lighting systems, require that tests be periodically carried out to verify both the functioning and the efficiency (duration in emergency) of the lighting fixtures which also the emergency lighting function. This forces the system maintainers to interrupt the power supply line and carry out tests on a weekly basis (functional test), and on a quarterly or annual basis (autonomy test).

With our emergency kits with self-test (complying with European standard EN 62034) these tests are carried out automatically with a programmable cadence during installation.

Furthermore, our inverter analyzes the normal switching on and off times of the appliance and carries out (where possible) the tests in the hours when people are absent.

Any anomalies are signaled by a red-green indicator (led). Starting from the color of the signal, it is possible to unequivocally establish any functioning problems as shown in the following table.

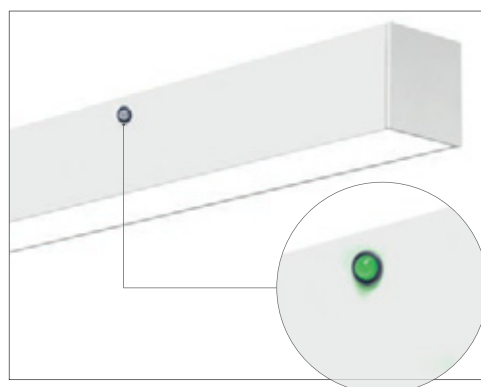

Colore LED - LED indication	Stato - Status
Verde fisso - Permanent Green	Batteria carica o in carica - Battery charge or charging
Verde lampeggiante - Flashing Green	Funzione TEST avviata - TEST in progress
Verde lampeggiante lento (1s ON - 1s OFF) Slow flashing green (1s ON - 1s OFF)	TEST di autonomia avviato Autonomy TEST in progress
Rosso fisso - Permanent Red	Lampada guasta - Lamp failure
Rosso lampeggio veloce (0,1s ON - 0,1s OFF) Fast flashing Red (0,1s ON - 0,1s OFF)	Guasto circuito di ricarica - Charging failure
Lampeggio Rosso lento (1s ON - 1s OFF) Slow flashing Red (1s ON - 1s OFF)	Batteria guasta - Battery failure
Verde e Rosso OFF - Green and Red OFF	Emergenza ON - Emergency ON

## Sky system S-C 40x40

Apparecchio singolo e fila continua  
Single devices and continuous line

A RICHIESTA  
ON DEMAND

0-10V

DALI 2



WIRELESS



### LED Sky slim S-C dark light, opale, asimmetrica.

Sistema luminoso modulare di spessore ridotto per file continue a sospensione o plafone in versione opale o con lenti, uffici, reception, supermarket, palestre. Elementi di giunzione di semplice utilizzo per linee continue o accessorio per angoli a 90°. Collegamento rapido con morsetto fast. Modulo cieco a richiesta predisposto per linea passante DALI, 0-10V. ed emergenza.

**A richiesta modello Biemissione vedi pag.242.**

**Installazione:** a sospensione S e parete W con accessorio (non incluso) o a plafone C con accessorio (non incluso), per montaggio a plafone in fila continua utilizzare lo specifico accessorio (non incluso).

**Corpo:** alluminio estruso anodizzato al naturale verniciato (goffrato) a polveri epossidiche bianco RAL 9010 e nero RAL 9005.

**Diffusore:** in policarbonato trasparente ad incastro a filo + film microstrutturato UGR<19.

**Diffusore asimmetrico e bi-asimmetrica:** lenti in PMMA e diffusore trasparente.

**Conforme alla norma:** EN60598-1, RG0 nessun rischio fotobiologico ai fini della norma EN62471.

**Led: Samsung SMD** mantenimento del flusso luminoso minimo al 80%: 50.000h (L80B10).

**Driver multipotenza:** Incluso > 50.000 h Fattore di potenza ≥0,95.

**A richiesta:** per quantità si esegue il settaggio dedicato della corrente del Driver e di conseguenza la potenza di W e Lm.

**Prodotto conforme alle direttive:**

### LED Sky slim S-C dark light, opal, asymmetrical.

Modular light system with reduced thickness for continuous rows, suspension or ceiling, in opal version or with lenses, for offices, receptions, supermarkets, gyms. Easy to use joining elements for continuous lines or 90° angle accessory.

Quick connection with fast clamp. Dummy model on demand designed for DALI feedthrough line, 0-10V. and emergency.

**On request Bi-emission model see page 242.**

**Installation:** suspension S or wall W with accessory (not included) or on ceiling C with accessory (not included), for ceiling mounting in a continuous row use the specific accessory (not included).

**Body:** natural anodised extruded aluminium painted (Textured) with white RAL 9010 and black RAL 9005 epoxy powders.

**Diffuser:** in flush joint transparent polycarbonate + microstructured film UGR <19.

**Asymmetric and bi-asymmetric diffuser:** lens in clear PMMA and transparent diffuser.

**Compliant with standard:** EN60598-1, RG0 no photobiological risk for the purposes mentioned in standard EN62471.

**Led: Samsung SMD** maintenance of 80% minimum luminous flux: 50,000h (L80B10).

**Multipower driver:** Included > 50,000 h Power factor ≥0.95.

**On request:** for quantity, the dedicated setting of the Driver current and consequently the power of W and Lm is carried out.

**Product compliant with directives:**

# Sky system per il Food

Per valorizzare i generi alimentari e prodotti freschi come frutta, verdura, pane e carne, è possibile (a richiesta) avere il sistema Sky con LED dedicati.

To enhance food and fresh products such as fruit, vegetables, bread and meat, it is possible (on request) to have the Sky system with dedicated LEDs.



## Ottica bread

la luce calda rivela la naturale colorazione di farinacei e prodotti di pasticceria  
*the warm light accentuates the natural coloring of starchy and pastry products*



## Ottica fruit -vegetables

aumenta la sensazione del cliente di acquistare di frutta e verdura fresche appena colte.  
*increases the customer's feeling of buying freshly picked fresh fruit and vegetables.*



## Ottica meat

accentua il colore della carne e dei salumi e ne risalta la freschezza.  
*accentuates the color of meat and cured meats and enhances their freshness.*



## Ottica fish

con luce fredda "glaciale" risalta la naturale freschezza del pesce e dei crostacei appena pescati  
*with cold "glacial" light, the natural freshness of freshly caught fish and crustaceans stands out*

# Sky system Emergenza Autotest

## Apparecchi di illuminazione cablati in emergenza

Relco nella politica di offrire un servizio migliore alla clientela, ha deciso di utilizzare nei suoi apparecchi di illuminazione dotati di emergenza, solo INVERTER PER EMERGENZA CON AUTOTEST.

## Emergency wired luminaires

Relco in its policy of offering a better service to customers, has decided to use only EMERGENCY INVERTER WITH SELF-TEST in its luminaires equipped with emergency.

Le norme europee EN 1838, EN 60598-2-22, relative ai sistemi di illuminazione di emergenza, impongono che periodicamente, siano effettuati dei test per verificare sia il funzionamento sia l'efficienza (durata in emergenza) degli apparecchi di illuminazione che svolgono anche la funzione di illuminazione di emergenza. Questo costringe i manutentori dell'impianto ad interrompere la linea di alimentazione ed effettuare test con cadenza settimanale (test funzionale), e con cadenza trimestrale o annuale (test di autonomia). Con i nostri kit di emergenza con autotest (conformi alla normativa europea EN 62034) queste prove vengono svolte automaticamente con cadenza programmabile in fase di installazione. Inoltre il nostro inverter analizza i tempi di normale accensione e spegnimento dell'apparecchio ed effettua (qualora possibile) i test nelle ore di assenza delle persone. Eventuali anomalie sono segnalate tramite un indicatore (led) rosso verde. A partire dal colore della segnalazione è possibile stabilire in maniera univoca gli eventuali problemi di funzionamento come evidenziato nella tabella seguente.

The European standards EN 1838, EN 60598-2-22, relating to emergency lighting systems, require that tests be periodically carried out to verify both the functioning and the efficiency (duration in emergency) of the lighting fixtures which also the emergency lighting function. This forces the system maintainers to interrupt the power supply line and carry out tests on a weekly basis (functional test), and on a quarterly or annual basis (autonomy test). With our emergency kits with self-test (complying with European standard EN 62034) these tests are carried out automatically with a programmable cadence during installation. Furthermore, our inverter analyzes the normal switching on and off times of the appliance and carries out (where possible) the tests in the hours when people are absent. Any anomalies are signaled by a red-green indicator (led). Starting from the color of the signal, it is possible to unequivocally establish any functioning problems as shown in the following table.

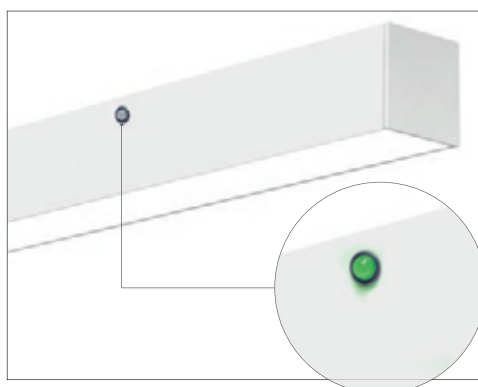

Colore LED - LED indication	Stato - Status
Verde fisso - Permanent Green	Batteria carica o in carica - Battery charge or charging
Verde lampeggiante - Flashing Green	Funzione TEST avviata - TEST in progress
Verde lampeggiante lento (1s ON - 1s OFF) Slow flashing green (1s ON - 1s OFF)	TEST di autonomia avviato Autonomy TEST in progress
Rosso fisso - Permanent Red	Lampada guasta - Lamp failure
Rosso lampeggio veloce (0,1s ON - 0,1s OFF) Fast flashing Red (0,1s ON - 0,1s OFF)	Guasto circuito di ricarica - Charging failure
Lampeggio Rosso lento (1s ON - 1s OFF) Slow flashing Red (1s ON - 1s OFF)	Batteria guasta - Battery failure
Verde e Rosso OFF - Green and Red OFF	Emergenza ON - Emergency ON



Ceiling/suspended/wall

220 240V	50/60 Hz	IK07	IP40	CRI 90	+40 C° -20	850°	CE				DRIVER INCLUDED MULTIPOWER	RG0
RETAIL	MARKET	SCHOOL 1+1=2 ABC	HOTEL	HOSPITAL	OFFICE	GYM	TOILET	EMER	Per lampade cablate in emergenza (aggiungere /EM dopo il codice) sovrapprezzo del 30%. Emergenza non possibile per versioni in linea continua. For wired emergency lights (add /EM after the code) 30% extra charge. Emergency not possible for versions in continuous line.			

### Sky system S-C 40x40

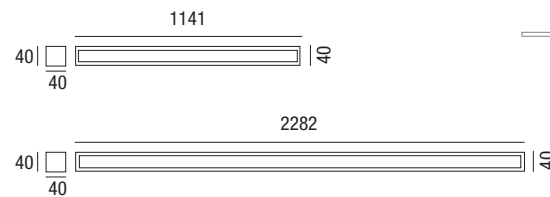
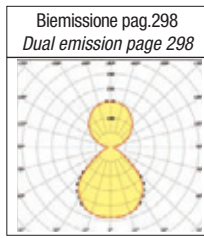
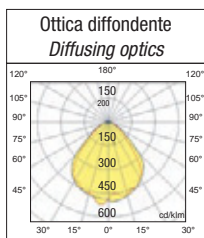

	colour	W max	Vac	lm output	lm/W	K	L [mm]	Kg	CELL
	B	30	220-240	3900	130	3000	1141	2.00	1003K
	B	30	220-240	3900	130	4000	1141	2.00	1004K
	DALI 2	B	30	220-240	3900	130	3000	2.00	1003KDA
	DALI 2	B	30	220-240	3900	130	4000	2.00	1004KDA
	N	30	220-240	3900	130	3000	1141	2.00	100B3K
	N	30	220-240	3900	130	4000	1141	2.00	100B4K
	DALI 2	N	30	220-240	3900	130	3000	2.00	100B3KDA
	DALI 2	N	30	220-240	3900	130	4000	2.00	100B4KDA
	B	50	220-240	6500	130	3000	2282	4.00	2003K
	B	50	220-240	6500	130	4000	2282	4.00	2004K
	DALI 2	B	50	220-240	6500	130	3000	4.00	2003KDA
	DALI 2	B	50	220-240	6500	130	4000	4.00	2004KDA
	N	50	220-240	6500	130	3000	2282	4.00	200B3K
	N	50	220-240	6500	130	4000	2282	4.00	200B4K
	DALI 2	N	50	220-240	6500	130	3000	4.00	200B3KDA
	DALI 2	N	50	220-240	6500	130	4000	4.00	200B4KDA

### Sky system S-C 40x40 asimmetrica

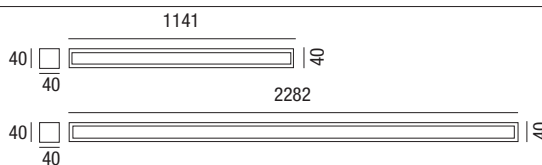
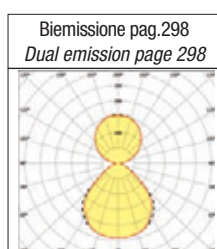
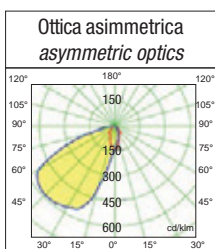

	colour	W max	Vac	lm output	lm/W	K	L [mm]	Kg	CELL
	B	30	220-240	3900	130	3000	1141	2.00	100AS3K
	B	30	220-240	3900	130	4000	1141	2.00	100AS4K
	DALI 2	B	30	220-240	3900	130	3000	2.00	100AS3KDA
	DALI 2	B	30	220-240	3900	130	4000	2.00	100AS4KDA
	N	30	220-240	3900	130	3000	1141	2.00	100ASB3K
	N	30	220-240	3900	130	4000	1141	2.00	100ASB4K
	DALI 2	N	30	220-240	3900	130	3000	2.00	100ASB3KDA
	DALI 2	N	30	220-240	3900	130	4000	2.00	100ASB4KDA
	B	50	220-240	6500	130	3000	2282	4.00	200AS3K
	B	50	220-240	6500	130	4000	2282	4.00	200AS4K
	DALI 2	B	50	220-240	6500	130	3000	4.00	200AS3KDA
	DALI 2	B	50	220-240	6500	130	4000	4.00	200AS4KDA
	N	50	220-240	6500	130	3000	2282	4.00	200ASB3K
	N	50	220-240	6500	130	4000	2282	4.00	200ASB4K
	DALI 2	N	50	220-240	6500	130	3000	4.00	200ASB3KDA
	DALI 2	N	50	220-240	6500	130	4000	4.00	200ASB4KDA



# Sky system S-C bi-asimmetrica

UGR < 19

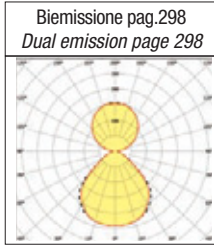
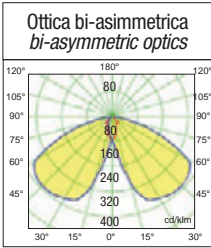
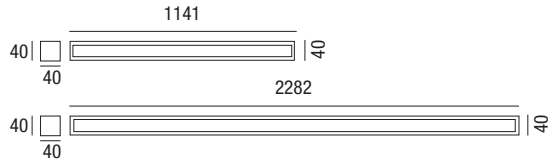

colour	W max	Vac	lm output	lm/W	K	L [mm]	Kg	CELL
B	30	220-240	3900	130	3000	1141	2.00	100BAS3K
B	30	220-240	3900	130	4000	1141	2.00	100BAS4K
<b>DALI 2</b> B	30	220-240	3900	130	3000	1141	2.00	100BAS3KDA
<b>DALI 2</b> B	30	220-240	3900	130	4000	1141	2.00	100BAS4KDA
N	30	220-240	3900	130	3000	1141	2.00	100BASB3K
N	30	220-240	3900	130	4000	1141	2.00	100BASB4K
<b>DALI 2</b> N	30	220-240	3900	130	3000	1141	2.00	100BASB3KDA
<b>DALI 2</b> N	30	220-240	3900	130	4000	1141	2.00	100BASB4KDA
B	50	220-240	6500	130	3000	2282	4.00	200BAS3K
B	50	220-240	6500	130	4000	2282	4.00	200BAS4K
<b>DALI 2</b> B	50	220-240	6500	130	3000	2282	4.00	200BAS3KDA
<b>DALI 2</b> B	50	220-240	6500	130	4000	2282	4.00	200BAS4KDA
N	50	220-240	6500	130	3000	2282	4.00	200BASB3K
N	50	220-240	6500	130	4000	2282	4.00	200BASB4K
<b>DALI 2</b> N	50	220-240	6500	130	3000	2282	4.00	200BASB3KDA
<b>DALI 2</b> N	50	220-240	6500	130	4000	2282	4.00	200BASB4KDA



Ottica asimmetrica - Asymmetric optics

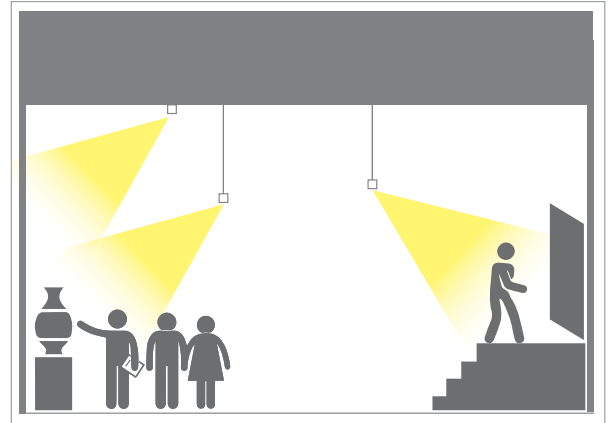

Ottica bi-asimmetrica - Bi-asymmetric optics

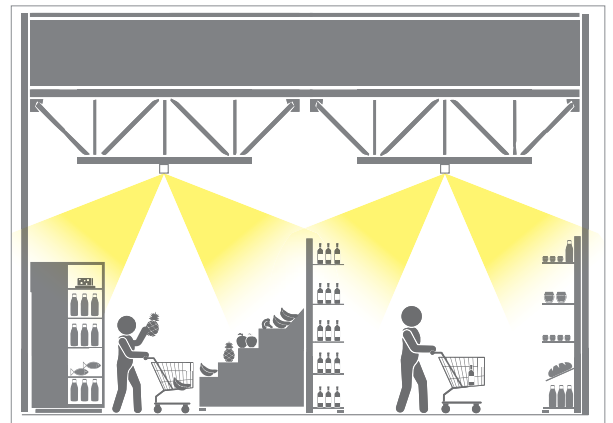

Ceiling/suspended/wall

Sky system Ottica ellittica a richiesta - Sky system Elliptical optic on demand

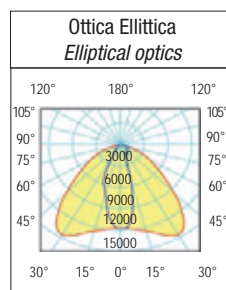
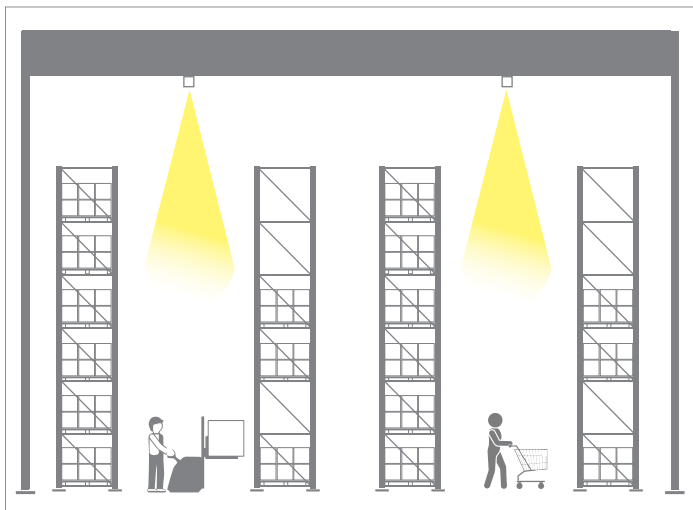

**A richiesta ottica ellittica 30°x90°**  
Ideale per illuminare ambienti con alte scaffalature o lunghi corridoi per la vendita al dettaglio, in modo da avere una luce diffusa e uniforme.

**On request elliptical optic 30°x90°**  
Ideal for lighting environments with high shelves or long corridors for retail, so as to have a uniformly diffused light.

Accessori a richiesta a sospensione - Suspension accessoires on demand



Staffa per parete wall bracket

Colour	Kg	PCS	Code
<b>B</b>	0,050	2 x profilo/profile L. 1141	104/2/C/WH
<b>B</b>	0,050	3 x profilo/profile L. 2282	104/3/C/WH
<b>N</b>	0,050	2 x profilo/profile L. 1141	104/2/C/BK
<b>N</b>	0,050	3 x profilo/profile L. 2282	104/3/C/BK

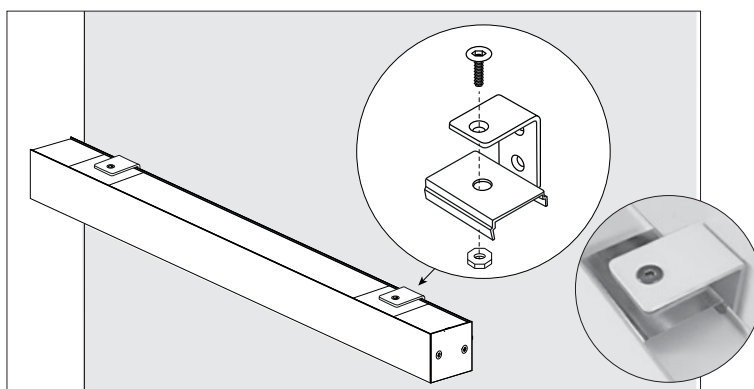
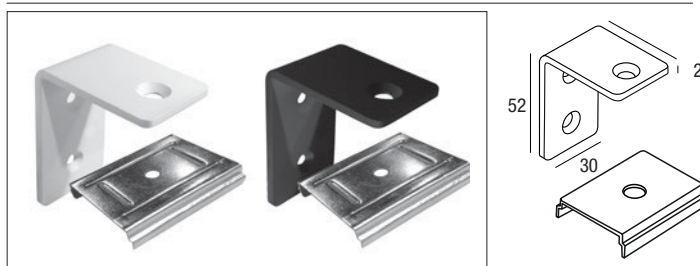



Ceiling/ suspended/ wall



Sky system 2 SPOT L. 1141 mm.

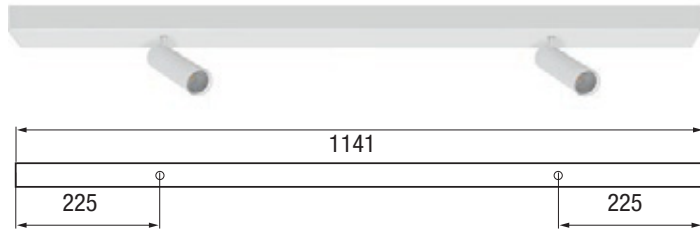

Colour	W	lm output	K	Angolo	Code
B	2x10	2x1700	3000	15 (36)	2SPOT/3K/15
B	2x10	2x1700	4000	15 (36)	2SPOT/4K/15
N	2x10	2x1700	3000	15 (36)	2SPOT/B/3K/15
N	2x10	2x1700	4000	15 (36)	2SPOT/B/4K/15

Sky system 3 SPOT L. 1141 mm.

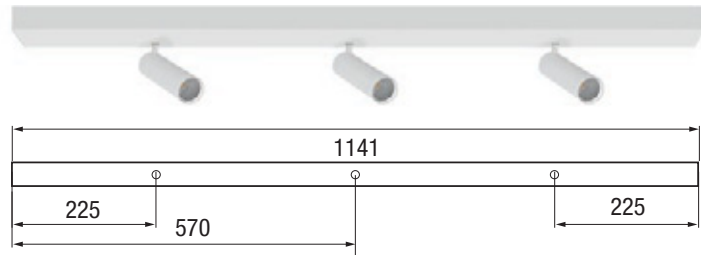

Colour	W	lm output	K	Angolo	Code
B	3x10	3x1700	3000	15 (36)	3SPOT/3K/15
B	3x10	3x1700	4000	15 (36)	3SPOT/4K/15
N	3x10	3x1700	3000	15 (36)	3SPOT/B/3K/15
N	3x10	3x1700	4000	15 (36)	3SPOT/B/4K/15

Spot 15°

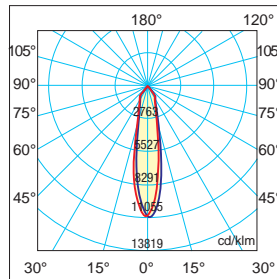

Spot 36° a richiesta on demand

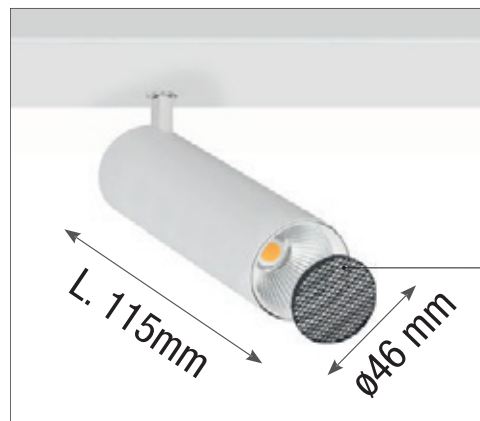
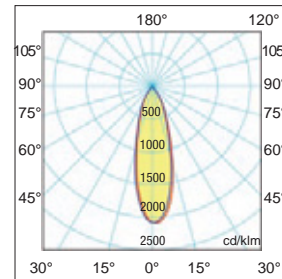

Frangiluce nido d'ape  
INCLUSO.  
INCLUDED  
Honeycomb louvre



# Sistema biemissione a richiesta

## Dual emission system on demand

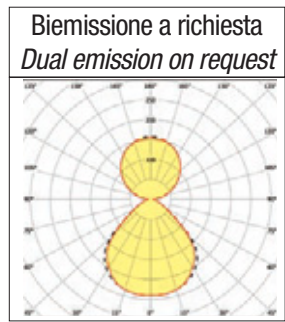

Sistema a biemissione applicabile a tutti i modelli **Led Sky system** lineari misura 1141 mm. e 2282 mm.  
Ideale per illuminazione rasente il muro, con doppia accensione.  
A richiesta con sovrapprezzo del 30%. (aggiungere /DM dopo il codice).  
**Non disponibile per Congiunzioni luminose a "T" o a "C".**

*Dual emission system applicable to all linear models **Led Sky system** measuring 1141mm. and 2282mm.  
Ideal for lighting close to the wall, with double switching.  
On request with 30% extra charge (add / DM after the code).  
**Not available for "T" or "C" Light Conjunctions.***

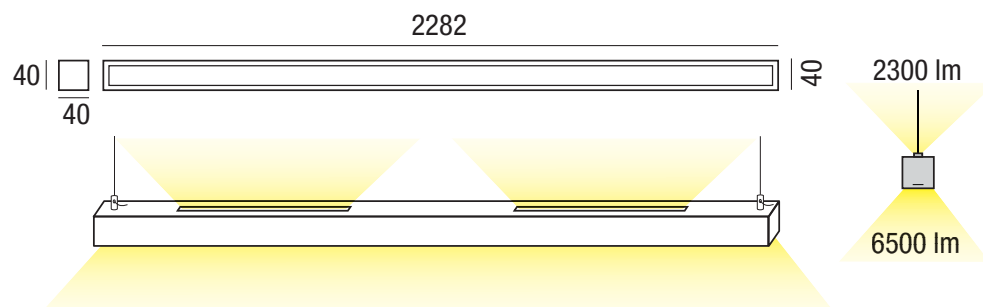
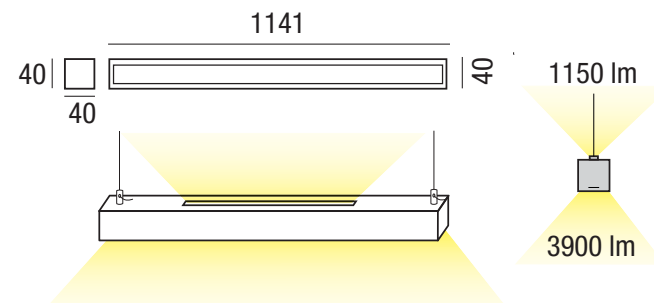

Frangiluce, evita che il flusso luminoso trafile tra i moduli Sky system in fila continua.

*Louvre mask, prevents the luminous flux from leaking between the Sky system modules in a continuous row.*

Ceiling/suspended/wall

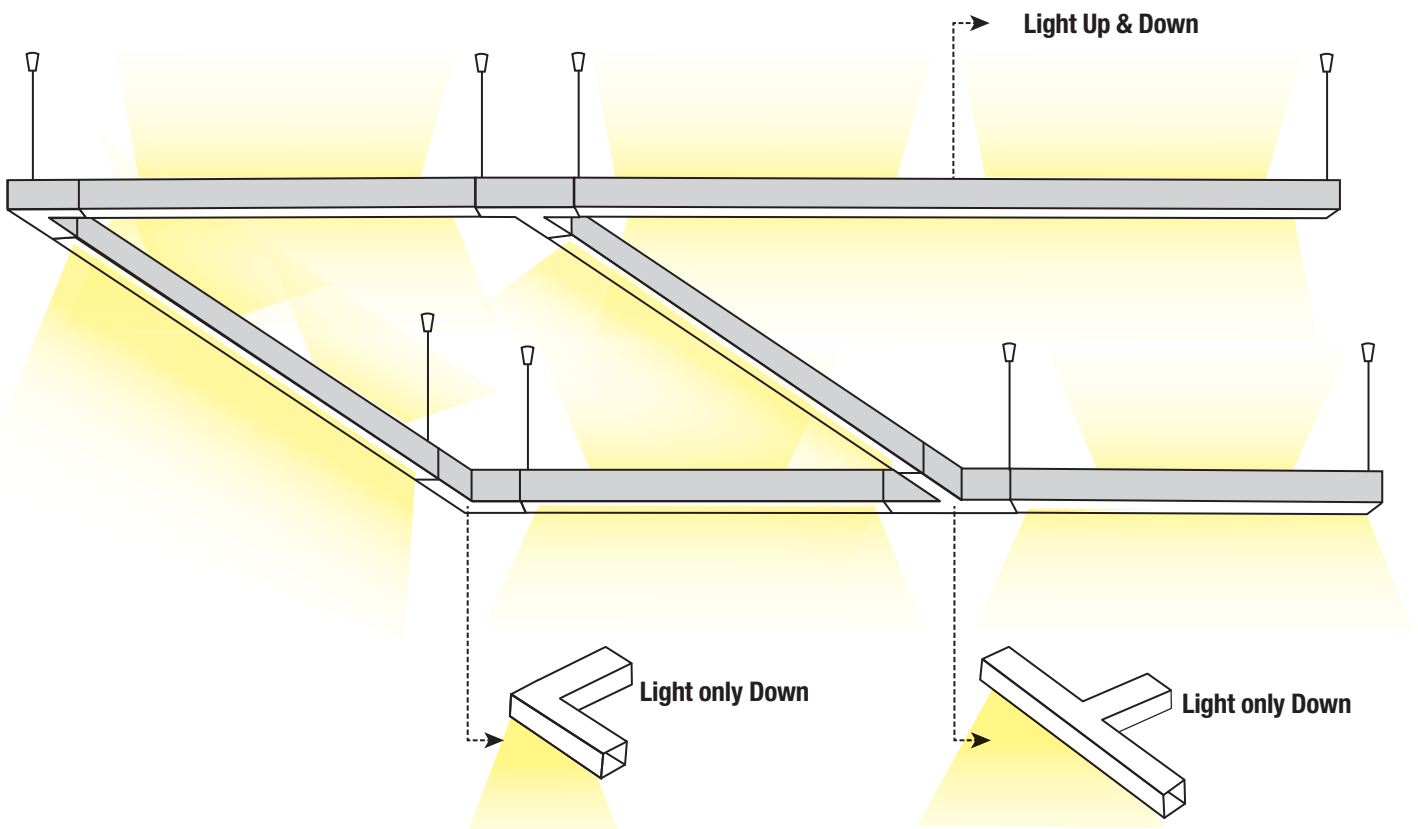

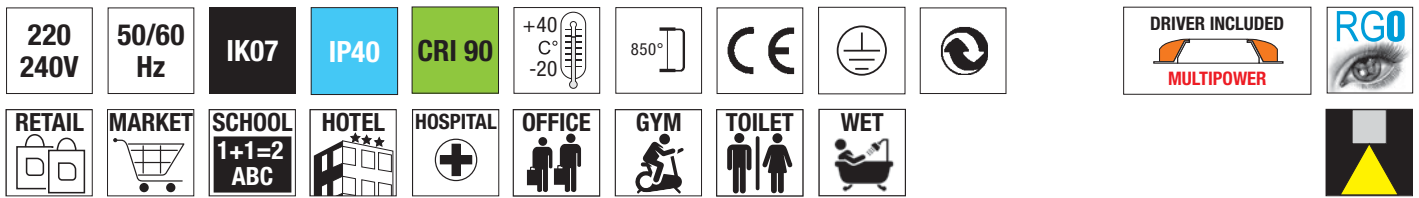

**KIT Congiunzione a L, luminoso - SOLO SOSPENSIONE**  
**KIT L-shaped angular joint - ONLY SUSPENDED**

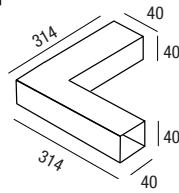

	colour	W max	Vac	lm output	lm/W	K	Kg	CELL
	B	15	220-240	1950	130	3000	0.20	100/3K/SC
	B	15	220-240	1950	130	4000	0.20	100/4K/SC
	DALI 2 B	15	220-240	1950	130	3000	0.20	100/3K/SCDA
	DALI 2 B	15	220-240	1950	130	4000	0.20	100/4K/SCDA
	N	15	220-240	1950	130	3000	0.20	100B/3K/SC
	N	15	220-240	1950	130	4000	0.20	100B/4K/SC
	DALI 2 N	15	220-240	1950	130	3000	0.20	100B/3K/SCDA
	DALI 2 N	15	220-240	1950	130	4000	0.20	100B/4K/SCDA

**EMER** Attenzione! nel caso il progetto venga fatto con sistema DALI+EMER non è possibile utilizzare questo modulo.  
**Attention!** if the project is done with the DALI + EMER system it is not possible to use this module.

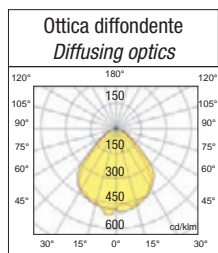

**KIT Congiunzione a T, luminoso - SOLO SOSPENSIONE**  
**KIT T-shaped angular joint - ONLY SUSPENDED**

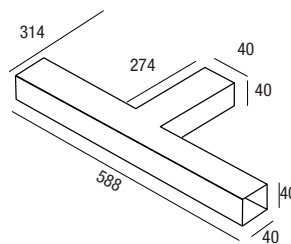
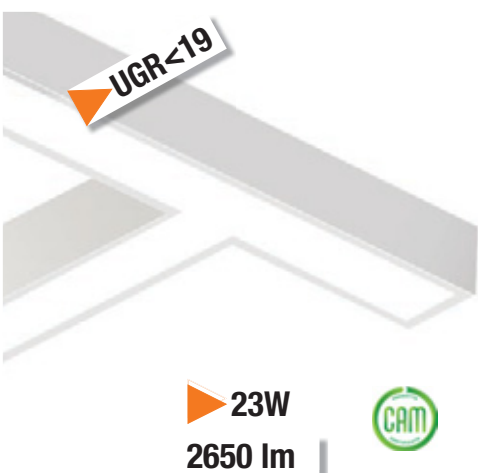

	colour	W max	Vac	lm output	lm/W	K	Kg	CELL
	B	23	220-240	2650	130	3000	0.20	101/3K/SC
	B	23	220-240	2650	130	4000	0.20	101/4K/SC
	DALI 2 B	23	220-240	2650	130	3000	0.20	101/3K/SCDA
	DALI 2 B	23	220-240	2650	130	4000	0.20	101/4K/SCDA
	N	23	220-240	2650	130	3000	0.20	101B/3K/SC
	N	23	220-240	2650	130	4000	0.20	101B/4K/SC
	DALI 2 N	23	220-240	2650	130	3000	0.20	101B/3K/SCDA
	DALI 2 N	23	220-240	2650	130	4000	0.20	101B/4K/SCDA

**EMER** Attenzione! nel caso il progetto venga fatto con sistema DALI+EMER non è possibile utilizzare questo modulo.  
**Attention!** if the project is done with the DALI + EMER system it is not possible to use this module.

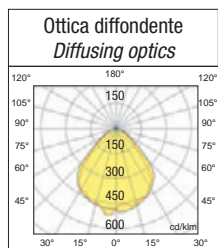

Ceiling/suspended/wall

# Sky system accessori - accessories

Accessori a richiesta a sospensione e plafone singole o linea continua  
*Suspension or ceiling accessories single or continuous lines on demand*

## Kit per montaggio a plafone - Ceiling mounting kit

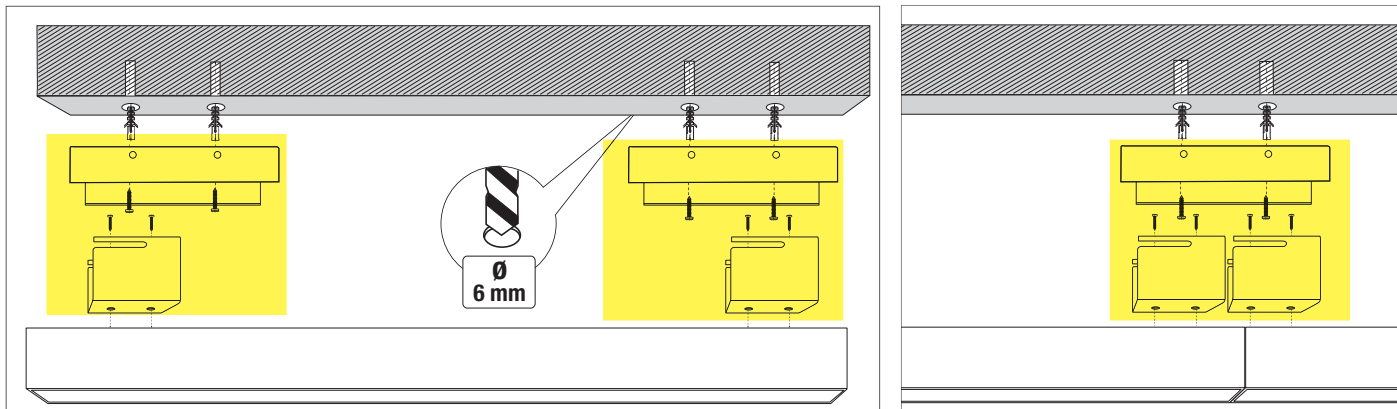

**104R2XSKY** 2 staffe per montaggio a plafone Sky system 1141mm.  
 2 Sky system ceiling mounting brackets 1141mm.

**104R3XSKY** 3 staffe per montaggio a plafone Sky system 2282mm.  
 3 Sky system ceiling mounting brackets 2282mm.

Esempio applicativo per montaggio staffe per file continue a plafone.

*Application example for ceiling-mounted continuous lines.*

## Kit di alimentazione - Power supply kit

Colour	Cavo	pcs	Kg	Code
B	3x1,5	1	0,01	102/3/C
B	5x1,5	2	0,01	102/5/C
N	3x1,5	1	0,01	102B/3/C
N	5x1,5	2	0,01	102B/5/C

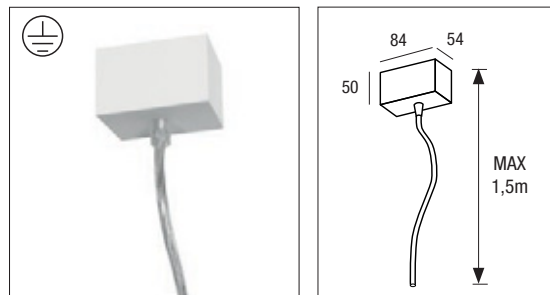

## Cavo per sospensione - Suspension cable

Colour	pcs	Kg	PCS	Code
B	001	0,250	1 cavi/cables	103/S

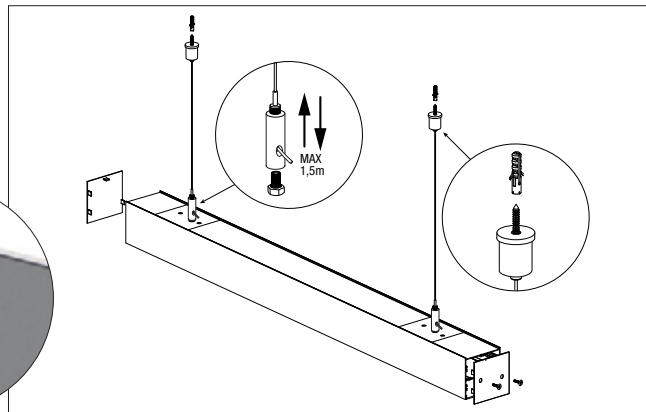
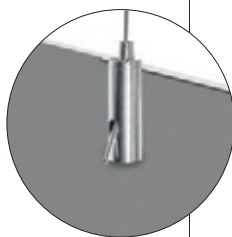
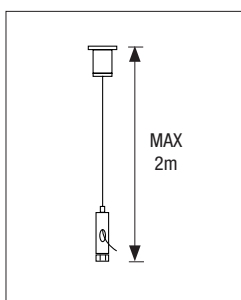

## Staffa di giunzione e mascherina per fila continua in sospensione - Junction bracket and continuous line screen for suspension

Colour	pcs	Kg	Code
B	1	0,01	100/SL/SKY

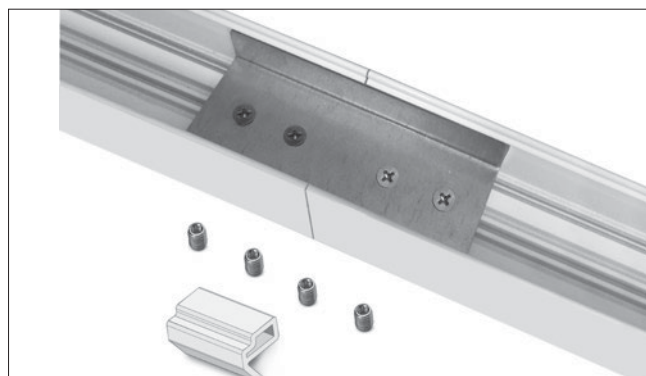
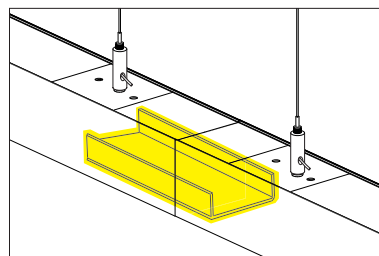
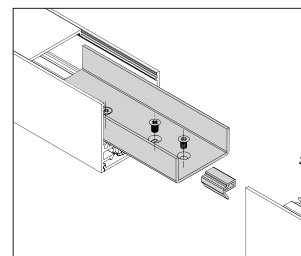



220 240V	50/60 Hz	IK07	IP40	CRI 90	+40 C -20	850°	CE				DRIVER INCLUDED MULTIPOWER	RG0
RETAIL	MARKET	SCHOOL 1+1=2 ABC	HOTEL	HOSPITAL	OFFICE	GYM	TOILET	WET	EMER	Per lampade cablate in emergenza (aggiungere /EM dopo il codice) sovrapprezzo del 30%. For wired emergency lights (add /EM after the code) 30% extra charge.		

### Sky system plafone C 40x40

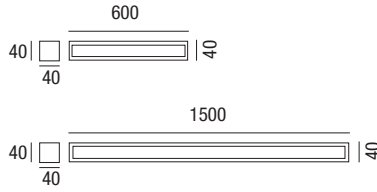

Non è possibile combinare Sky system plafone C con le lampade Sky system S-C (misure 1141 e 2282mm)  
It is not possible to combine Sky system ceiling C with Sky system S-C lamps (sizes 1141 and 2282mm)

	colour	W max	Vac	lm output	lm/W	K	L [mm]	Kg	CELL
	B	20	220-240	2600	130	3000	600	2.00	603K
	B	20	220-240	2600	130	4000	600	2.00	604K
	DALI 2	B	20	220-240	2600	130	3000	2.00	603KDA
	DALI 2	B	20	220-240	2600	130	4000	2.00	604KDA
	N	20	220-240	2600	130	3000	600	2.00	60B3K
	N	20	220-240	2600	130	4000	600	2.00	60B4K
	DALI 2	N	20	220-240	2600	130	3000	2.00	60B3KDA
	DALI 2	N	20	220-240	2600	130	4000	2.00	60B4KDA
	B	50	220-240	5200	130	3000	1500	4.00	1503K
	B	50	220-240	5200	130	4000	1500	4.00	1504K
	DALI 2	B	50	220-240	5200	130	3000	4.00	1503KDA
	DALI 2	B	50	220-240	5200	130	4000	4.00	1504KDA
	N	50	220-240	5200	130	3000	1500	4.00	150B3K
	N	50	220-240	5200	130	4000	1500	4.00	150B4K
	DALI 2	N	50	220-240	5200	130	3000	4.00	150B3KDA
	DALI 2	N	50	220-240	5200	130	4000	4.00	150B4KDA

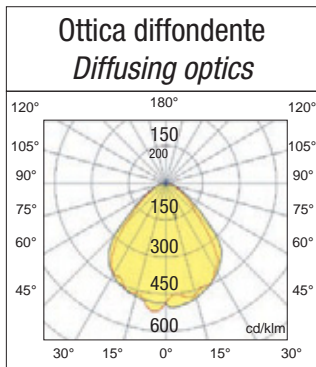

### Accessori non inclusi - Not included accessories

#### Montaggio a plafone singola lampada Single lamp ceiling mounting

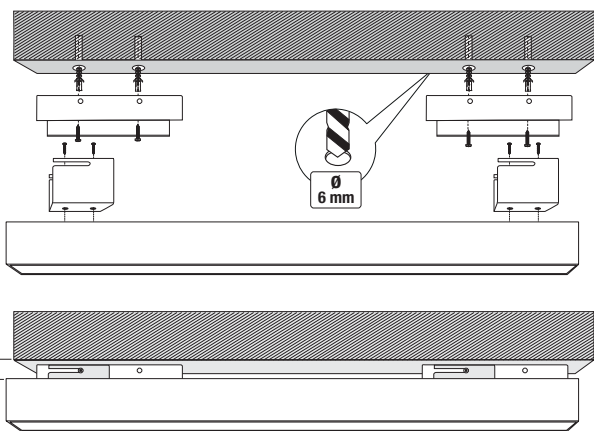

#### Montaggio a plafone in linea continua Continuous line ceiling mounting

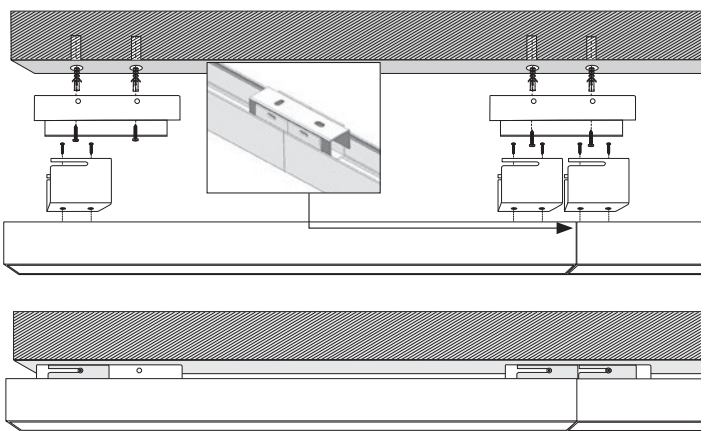

**104R2XSKY**  
2 staffe per montaggio a plafone Sky system 1141mm.  
2 Sky system ceiling mounting brackets 1141mm.

**104R3XSKY** 3 staffe per montaggio a plafone Sky system 2282mm.  
3 Sky system ceiling mounting brackets 2282mm.

Esempio montaggio a plafone in fila continua misura 600 e 1500mm.  
Example of ceiling mounting in a continuous row sizes 600 and 1500mm.



**Led SMD 8W**  
700mA



**Led SMD 10W**  
500mA



**Led COB 13W**  
350mA



Recessed



Ferma



Beautylight



Cielo QR



Cielo RR



Gloria RR



Gloria RR trimless



Gloria QR



Gloria QR trimless



Imperceptible



Gessi

Recessed

# LED Ferma

A RICHIESTA  
ON DEMAND

WIRELESS

0-10V

DALI 2



LED Ferma, incassi a LED con ottica arretrata fissa ideale per gli ambienti commerciali, residenziali e in qualsiasi ambiente dove è necessaria un'illuminazione spot e d'accento senza abbagliamento.

Apparecchi semplici ma efficaci a base tonda o quadra con cornice, ideali per sostituire apparecchi con sorgenti dicroiche da 50W.

**Installazione:** incasso a soffitto

**Corpo:** alluminio pressofuso. Verniciatura di tipo poliestere eseguita a polvere.

**Conforme alla norma:** EN60598-1, RG0 nessun rischio fotobiologico ai fini della norma EN62471.

**LED:** mantenimento del flusso luminoso minimo al 80%: 50.000h (L80B10).

**Driver:** incluso nel Kit.

*LED Ferma, LED Firma, LED series downlighter with fixed optic in rear position, ideal for residential and retail environments, and for any other space that requires accent spot lighting without glare. It is a simple, yet effective fixture with round or square body and frame, ideal to replace luminaires with 50W dichroic lamps.*

**Installation:** ceiling recessed.

**Body:** die-cast aluminium. Polyester powder coating.

**According to standard:** EN60598-1, RG0 exempt from photo-biological risks in compliance with standard EN62471.

**LED:** maintenance of minimum luminous flux to 80%: 50.000h (L80B10).

**Driver:** included in Kit.

220-240V 50/60Hz 850° IP20 IK04  
IP44 IK04

## LED Ferma

G



Led SMD 8W

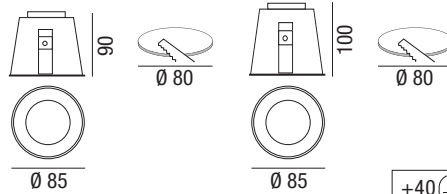

8W - 10W

13W



DRIVER INCLUDED  
MULTIPOWER

CRI 90



B



Led SMD 10W

B

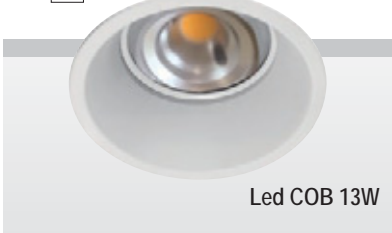

Led COB 13W

colour	W max	Lm Output	△	mA max	K	pcs	Kg	CELL
	8	800	40°	700	3000	001	0,314	30779/WNAP
	8	800	40°	700	3000	001	0,314	30779/WNAPDA
	8	800	40°	700	4000	001	0,314	30779/WNAP4K
	8	800	40°	700	4000	001	0,314	30779/WNAP4KD
	10	1050	25°	500	3000	001	0,314	30777/W
	10	1050	25°	500	4000	001	0,314	30777/W/4K
	10	1050	40°	500	3000	001	0,314	30779/W
	10	1050	40°	500	3000	001	0,314	30779/W/DALI
	13	1400	25°	350	3000	001	0,314	30777/W/V10
	13	1400	40°	350	3000	001	0,314	30779/W/V10
	13	1400	40°	350	3000	001	0,314	30779/W/V10DA
	13	1400	40°	350	4000	001	0,314	30779WV104K
	13	1400	40°	350	4000	001	0,314	30779WV104KDA

## Dati fotometrici - Photometric data

25°

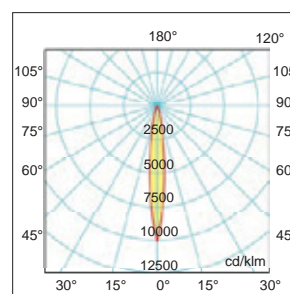

40°

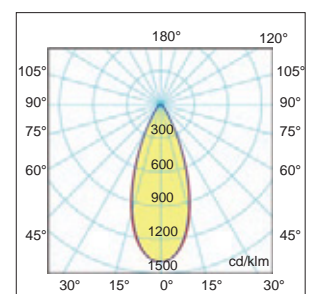



## LED Cielo QR - RR -3RR



Recessed

Incassi a LED con frontali antiabbagliamento in varie finiture sostituibili a piacere, vista la facile installazione.

Ideale per un'illuminazione piacevole ed omogenea in strutture pubbliche, uffici, Hotel e reparti wellness, oppure negozi e centri commerciali, se montato in soffitti chiusi, il downlight raggiunge la protezione IP44 e quindi può essere montato in zone più critiche.

**Installazione:** incasso a soffitto.

**Corpo:** alluminio pressofuso. Verniciatura di tipo poliestere eseguita a polvere bianco RAL9010.

**Ottica:** arretrata direzionabile  $\pm 15^\circ$ . Standard  $40^\circ$  a richiesta  $25^\circ$ .

**Conforme alla norma:** EN60598-1, RG0 nessun rischio fotobiologico ai fini della norma EN62471.

**LED:** mantenimento del flusso luminoso minimo al 80%: 50.000h (L80B10).

**Driver:**  incluso nel Kit.

*LED recessed luminaires with anti-glare fronts in various finishes that can be replaced at will, given the easy installation.*

*Ideal for pleasant and homogeneous lighting in public buildings, offices, hotels and wellness departments, or shops and shopping centres, if mounted in closed ceilings, the downlight achieves IP44 protection and therefore can be mounted in more critical areas.*

**Installation:** ceiling recessed

**Body:** die-cast aluminium. Polyester powder coating White RAL 9010.

**Optics:** set back, adjustable  $\pm 15^\circ$ . Standard  $40^\circ$  on request  $25^\circ$ .

**According to standard:** EN60598-1, RG0 exempt from photo-biological risks in compliance with standard EN62471.

**LED:** maintenance of minimum luminous flux to 80%: 50.000h (L80B10).

**Driver:**  included in Kit.

# LED Cielo QR - RR -3RR



## Accessori non inclusi - Accessories not included

Frontali antiabbagliamento disponibile in vari colori e finiture.  
Anti-glare panels available in various colours and finishes.



**cod. 48000**  
**orientabile/orientable**  
Bianco opaco  
Matt White



**cod. 48001**  
**orientabile/orientable**  
Nero opaco  
Matt black



**cod. 48002**  
**orientabile/orientable**  
Argento sabbaiato  
Sandy Silver



**cod. 48003**  
**orientabile/orientable**  
Cromo nero UV lucido  
UV Black chrome



**cod. 48004**  
**orientabile/orientable**  
Cromo lucido UV  
UV polished chrome

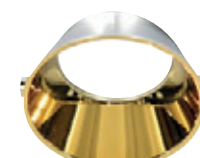

**cod. 48005**  
**orientabile/orientable**  
Oro lucido UV  
UV polished Gold



**cod. 48006**  
**orientabile/orientable**  
Rame lucido UV  
UV polished Copper

## Sorgente luminosa e frontali antiabbagliamento a scelta - Choice of light source and anti-glare fronts

8W - 10W - 13W  
LED SMD - LED COB

**BASIC series**  
7W - GU10 230V.



8W - 10W - 13W  
LED SMD - LED COB

**BASIC series**  
7W - GU10 230V.



Riflettore da ordinare a parte  
Reflector to be ordered separately

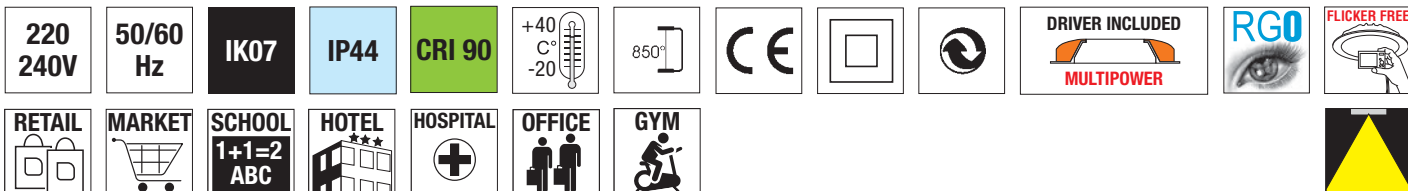

### LED Cielo QR

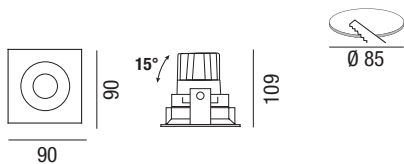

	W max	Lm Output	Beam Angle	mA max	K	pcs	Kg	S+L
B	7	Led GU10	700	36°	-	3000	0,314	48009GU10 *
B	7	Led GU10	700	36°	-	4000	0,314	48009GU10/4K *

\* Q.tà minima 20 pcs - Minimum quantity 20 pcs

	W max	Lm Output	Beam Angle	mA max	K	pcs	Kg	CELL
B	8	880	40° (25)	700	3000	001	0,314	48009NAPO
B	8	880	40° (25)	700	4000	001	0,314	48010NAPO
DALI 2	B	8	880	40° (25)	700	3000	001	48009DALNAPO
DALI 2	B	8	880	40° (25)	700	4000	001	48010DALNAPO
B	10	1100	40° (25)	500	3000	001	0,314	48009/3K
B	10	1100	40° (25)	500	4000	001	0,314	48010/4K
DALI 2	B	10	1100	40° (25)	500	3000	001	48009DALI
DALI 2	B	10	1100	40° (25)	500	4000	001	48010DALI
B	13	1430	40° (25)	350	3000	001	0,314	48011/3K
B	13	1430	40° (25)	350	4000	001	0,314	48012/4K
DALI 2	B	13	1430	40° (25)	350	3000	001	48011DALI
DALI 2	B	13	1430	40° (25)	350	4000	001	48012DALI

### LED Cielo RR

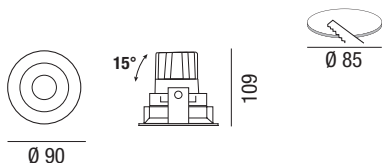
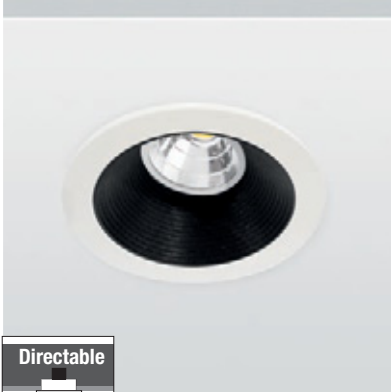

	W max	Lm Output	Beam Angle	mA max	K	pcs	Kg	S+L
B	7	Led GU10	700	36°	-	3000	0,314	49009GU10 *
B	7	Led GU10	700	36°	-	4000	0,314	49010GU10/4K *

\* Q.tà minima 20 pcs - Minimum quantity 20 pcs

	W max	Lm Output	Beam Angle	mA max	K	pcs	Kg	CELL
B	8	880	40° (25)	700	3000	001	0,314	49009NAPO
B	8	880	40° (25)	700	4000	001	0,314	49010NAPO
DALI 2	B	8	880	40° (25)	700	3000	001	49009DALNAPO
DALI 2	B	8	880	40° (25)	700	4000	001	49010DALNAPO
B	10	1100	40° (25)	500	3000	001	0,314	49009/3K
B	10	1100	40° (25)	500	4000	001	0,314	49010/4K
DALI 2	B	10	1100	40° (25)	500	3000	001	49009DALI
DALI 2	B	10	1100	40° (25)	500	4000	001	49010DALI
B	13	1430	40° (25)	350	3000	001	0,314	49011/3K
B	13	1430	40° (25)	350	4000	001	0,314	49011/4K
DALI 2	B	13	1430	40° (25)	350	3000	001	49011DALI
DALI 2	B	13	1430	40° (25)	350	4000	001	49012DALI



## LED Cielo 3RR

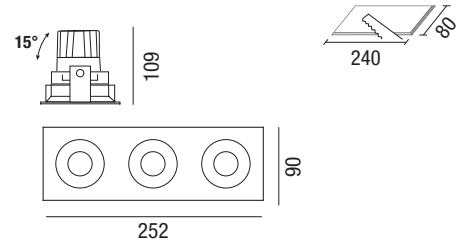

	W max		Lm Output		mA max	K	pcs	Kg	S+L
B	3x7	Led GU10	3x700	36°	-	3000	001	0,700	38009GU10 *
B	3x7	Led GU10	3x700	36°	-	4000	001	0,700	38009GU10/4K *

\* Q.tà minima 20 pcs - Minimum quantity 20 pcs

	W max	Lm Output		mA max	K	pcs	Kg	CELL	
B	3x8	3x880	40° (25)	700	3000	001	0,900	38009NAPO	
B	3x8	3x880	40° (25)	700	4000	001	0,900	38010NAPO	
	B	3x8	3x880	40° (25)	700	3000	001	0,900	38009DALNAPO
	B	3x8	3x880	40° (25)	700	4000	001	0,900	38010DALNAPO
B	3x10	3x1100	40° (25)	500	3000	001	0,900	38009/3K	
B	3x10	3x1100	40° (25)	500	4000	001	0,900	38010/4K	
	B	3x10	3x1100	40° (25)	500	3000	001	0,900	38009DALI
	B	3x10	3x1100	40° (25)	500	4000	001	0,900	38010DALI
B	3x13	3x1430	40° (25)	350	3000	001	0,900	38011/3K	
B	3x13	3x1430	40° (25)	350	4000	001	0,900	38012/4K	
	B	3x13	3x1430	40° (25)	350	3000	001	0,900	38011DALI
	B	3x13	3x1430	40° (25)	350	4000	001	0,900	38012DALI

### Tabella di scelta potenza driver LED (incluso) - LED Power supply table choice (included)



Fornito di dip switch per la selezione della tensione in uscita. Il driver incluso nella confezione è normalmente settato alla massima corrente. Se necessario è possibile diminuire la potenza e di conseguenza i lumen output.

Equipped with dip switch for selecting the voltage output. The driver included inside the package is usually set to max power. If necessary it is possible to decrease the power and consequently the lumen output.

### Esempio applicativo Cielo 13W - Cielo 13W application example

Taratura - Dip-switch	Potenza - Power
mA	Watt
200	7
250	9
300	11
350	13
Taratura standard di fabbrica Driver Standard factory setting	

### Dati fotometrici - Photometric data

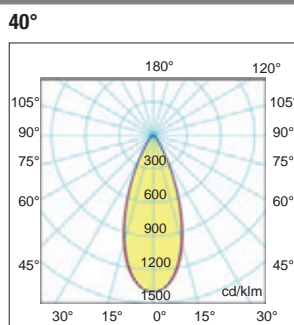
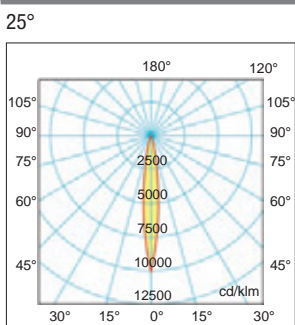

**Cod. 65151LED80CP3**  
Kit emergenza 3W - 3h/12% 180÷250 Vac  
180÷250 Vac - 3h/12% - 3W emergency kit

**Cod. RP0714CP3 - AUTOTEST**  
Kit emergenza 3W - 3h/12% 180÷250 Vac  
180÷250 Vac - 3h/12% - 3W emergency kit

## LED Beautylight

A RICHIESTA  
ON DEMAND

0-10V



Faretto LED ad incasso in alluminio pressofuso con diverse finiture con schermo in vetro satinato, grado IP65. Idoneo per applicazioni in zone umide, ottimo il suo utilizzo in centri benessere, laddove si necessiti di un grado IP elevato.

**Installazione:** incasso a soffitto.

**Corpo:** alluminio pressofuso.

**Orientabilità:** fisso.

**Verniciatura:** di tipo poliestere, eseguita a polvere bianco RAL 9010.

**Cablaggio:** rapido, come da foto.

**Conforme alla norma:** EN60598-1, RG0 nessun rischio fotobiologico ai fini della norma EN62471.

**Led:** mantenimento del flusso luminoso minimo al 80%: 50.000h (L80B10).

**Driver:**  incluso nel Kit.

*Recessed LED spotlight in die cast aluminium with different finishes with satin-finish glass screen, protection rating IP65. Suitable for applications in humid areas, ideal for use in well-being facilities, requiring a high IP rating.*

**Installation:** ceiling recessed

**Body:** die cast aluminium

**Adjustable:** vertical 45°

**Coating:** coated with powder polyester white RAL 9010.

**Wiring:** fast, like a photo.

**According to standard:** EN60598-1, RG0 exempt from photo-biological risks in compliance with standard EN62471.

**Led:** maintenance of minimum luminous flux to 80%: 50.000h (L80B10).

**Driver:**  included in Kit.

220-240V 50/60Hz      **IK03** **IP65**

**Kit LED Beautylight - FIX**

**IP65**

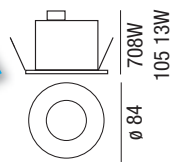

**CRI 90**

**DRIVER INCLUDED**  
**MULTIPOWER**



colour	W max		mA	Lm	K	pcs	Kg	CELL
<b>B</b>	8	40°	700	880	3000	010	0.60	30611NAPO
<b>B</b>	13	40°	350	1430	3000	010	0.60	30611/VL
<b>DALI 2</b> <b>B</b>	8	40°	700	880	3000	010	0.60	30611NAPODA
<b>DALI 2</b> <b>B</b>	13	40°	350	1430	3000	010	0.60	30611/VLDA
<b>B</b>	13	40°	700	1430	4000	010	0.60	30611/VL/4K



**Recessed**

## LED Gloria RR

A RICHIESTA  
ON DEMAND

0-10V

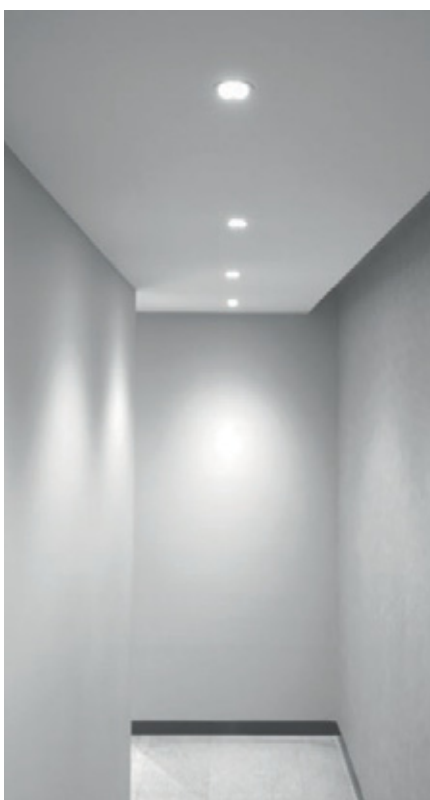

### Accessori non inclusi - Accessories not included

Frontali antiabbagliamento disponibile in vari colori e finiture.  
Anti-glare panels available in various colours and finishes.



**cod. 45000**  
**fisso/fix**  
Bianco satinato  
Frosted White



**cod. 45001**  
**fisso/fix**  
Nero satinato  
Frosted Black



**cod. 46001**  
**orientabile/orientable**  
Bianco satinato  
Frosted White



**cod. 46002**  
**orientabile/orientable**  
Nero satinato  
Frosted Black



**cod. 46003**  
**orientabile/orientable**  
Argento a specchio  
Mirror-finish silver



**cod. 46004**  
**orientabile/orientable**  
Oro satinato  
Frosted Gold



**cod. 46005**  
A filo muro  
Trimless



**cod. 46006**  
**Semi asimmetrico**  
solo LED COB 13W  
**Semi asymmetric**  
LED COB 13W only

Cod.46006

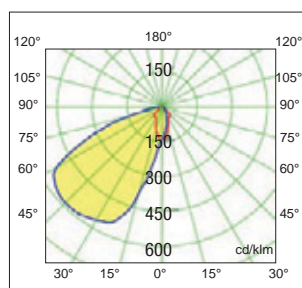

**cod. 46011**  
**Semi concentrante**  
solo LED COB 13W  
**Semi-concentrating**  
LED COB 13W only

Cod.46011

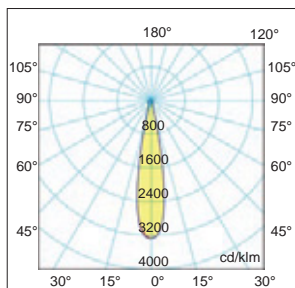

Montaggio a filo senza cornice da  
abbinare ai frontali antiabbagliamento.  
Trimless flush mounting to be  
combined with Anti-glare panels



cod. 45000  
cod. 45001  
cod. 46001  
cod. 46002  
cod. 46003  
cod. 46004  
cod. 46006  
cod. 46011

Recessed

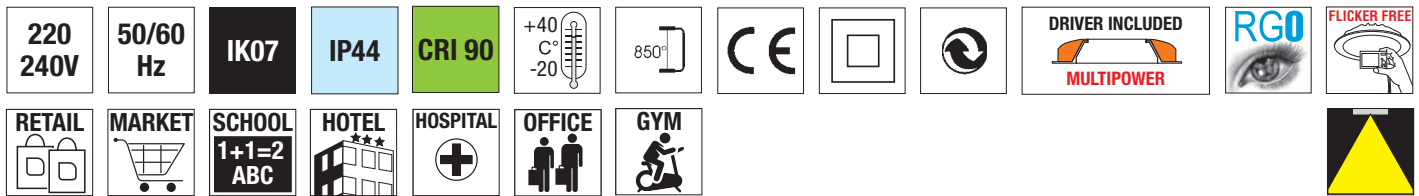

LED Gloria, downlight con frontale antiabbagliamento per installazioni ad incasso, con ottica arretrata orientabile  $\pm 30^\circ$  asse verticale e  $355^\circ$  sull'asse frontale, ideale per gli ambienti commerciali, residenziali e in qualsiasi ambiente dove è necessaria un'illuminazione spot e d'accento senza abbagliamento. Frontale antiabbagliamento disponibile in differenti colori. Corpo del prodotto realizzato in pressofusione di alluminio verniciato con tecnica powder coating e polveri con elevato grado di purezza. L'ottica speciale permette la creazione della distribuzione rettangolare della luce. La gamma si compone di prodotti con sistema di fissaggio tramite molle piatte, oppure in versione trimless per rasatura in cartongesso.

**Installazione:** incasso a soffitto.

**Corpo:** alluminio pressofuso. Verniciato bianco (RAL 9003) con tecnica powder coating e polveri con elevato grado di purezza.

**Riflettore (non incluso):** in PC placcato in alluminio antiabbagliamento, disponibile in differenti colori.

**Conforme alla norma:** EN60598-1, RGO nessun rischio fotobiologico ai fini della norma EN62471.

**LED COB:** mantenimento del flusso luminoso minimo al 80%: 50.000h (L80B10).

**Driver:** incluso.

**Prodotto conforme alle direttive:**

*Gloria LED, downlight with anti-glare panel for flush mounting installations, with recessed adjustable optics  $\pm 30^\circ$  vertical axis and  $255^\circ$  on the front axis, ideal for commercial and residential rooms and in any room where spot and accent lighting without glare is required. Anti-glare panel available in various colours.*

*Product body made of die-cast aluminium painted via powder coating technique and powders with a high degree of purity.*

*The special optics create a rectangular light distribution.*

*The range consists of products with a fixing system using flat springs, or in the trimless version for plasterboard finishing.*

**Installation:** ceiling flush mounting.

**Body:** die-cast aluminium. White painted (RAL 9003) with powder coating technique and powders with a high degree of purity.

**Reflector (not included):** in anti-glare aluminium plated PC, available in various colours.

**Compliant with standard:** EN60598-1, RGO no photobiological risk for the purposes mentioned in standard EN62471.

**COB LED:** maintenance of 80% minimum luminous flux: 50,000h (L80B10).

**Driver:** included.

**Product compliant with directives:**

### LED Gloria RR

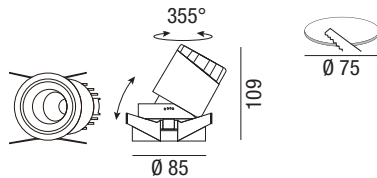

	W max	Lm Output		mA max	K	pcs	Kg	CELL
B	8	800	40°	700	3000	001	0,314	46009NAPO
B	8	800	40°	700	4000	001	0,314	46010NAPO
B	8	800	40°	700	3000	001	0,314	46009DALNAPO
B	8	800	40°	700	4000	001	0,314	46010DALNAPO
B	13	1400	25°	350	3000	001	0,314	46007
B	13	1400	25°	350	4000	001	0,314	46008
B	13	1400	40°	350	3000	001	0,314	46009
B	13	1400	40°	350	4000	001	0,314	46010
B	13	1400	40°	350	3000	001	0,314	46009DALI
B	13	1400	40°	350	4000	001	0,314	46010DALI

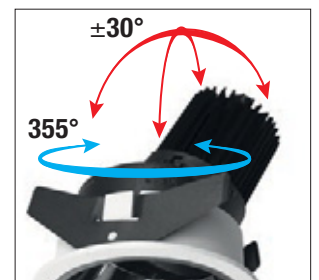

### Tabella di scelta potenza driver LED (incluso) - LED Power supply table choice (included)



### Dati fotometrici - Photometric data

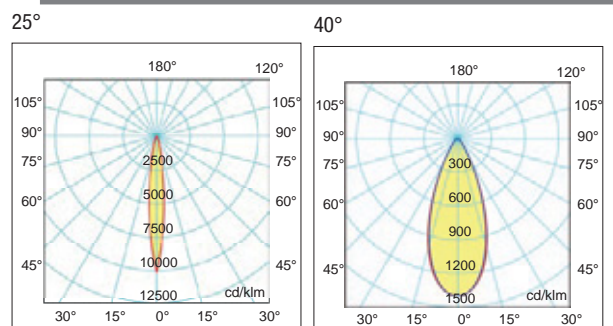

Fornito di dip switch per la selezione della tensione in uscita. Il driver incluso nella confezione è normalmente settato alla massima corrente. Se necessario è possibile diminuire la potenza e di conseguenza i lumen output.

*Equipped with dip switch for selecting the voltage output. The driver included inside the package is usually set to max power. If necessary it is possible to decrease the power and consequently the lumen output.*

## LED Gloria QR

A RICHIESTA  
ON DEMAND

0-10V

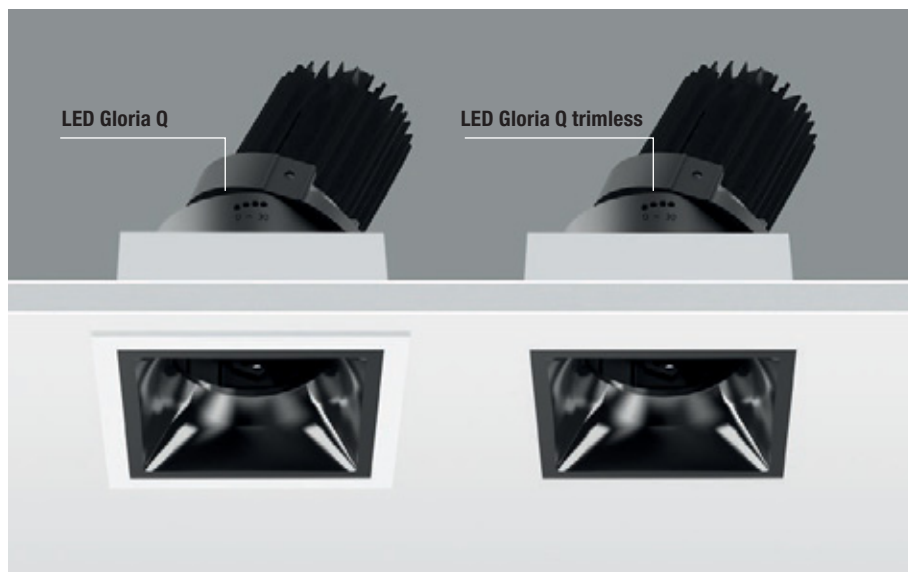

### Accessori non inclusi - Accessories not included

Frontali antiabbagliamento disponibile in vari colori e finiture.  
*Anti-glare panels available in various colours and finishes.*

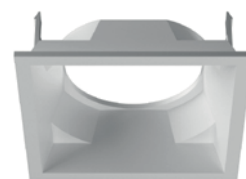

**cod. 47015**  
Bianco satinato  
*Frosted White*



**cod. 47014**  
Nero satinato  
*Frosted Black*



**cod. 47013**  
Argento a specchio  
*Mirror-finish silver*



**cod. 47012**  
Semi concentrante  
*Semi-concentrating*



**cod. 47011**  
A filo muro  
*Trimless*

Montaggio a filo senza cornice da  
abbinare ai frontali antiabbagliamento.  
*Trimless flush mounting to be  
combined with Anti-glare panels*



cod. 47012  
cod. 47013  
cod. 47014  
cod. 47015

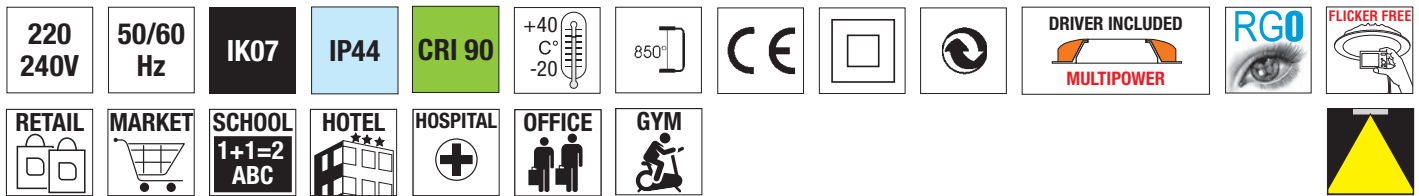

LED Gloria, downlight con frontale antiabbagliamento per installazioni ad incasso, con ottica arretrata orientabile  $\pm 30^\circ$  asse verticale e  $355^\circ$  sull'asse frontale, ideale per gli ambienti commerciali, residenziali e in qualsiasi ambiente dove è necessaria un'illuminazione spot e d'accento senza abbagliamento. Frontale antiabbagliamento disponibile in differenti colori. Corpo del prodotto realizzato in pressofusione di alluminio verniciato con tecnica powder coating e polveri con elevato grado di purezza. L'ottica speciale permette la creazione della distribuzione rettangolare della luce. La gamma si compone di prodotti con sistema di fissaggio tramite molle piatte, oppure in versione trimless per rasatura in cartongesso.

**Installazione:** incasso a soffitto.

**Corpo:** alluminio pressofuso. Verniciato bianco (RAL 9003) con tecnica powder coating e polveri con elevato grado di purezza.

**Riflettore (non incluso):** in PC placcato in alluminio antiabbagliamento, disponibile in differenti colori.

**Conforme alla norma:** EN60598-1, RGO nessun rischio fotobiologico ai fini della norma EN62471.

**LED COB:** mantenimento del flusso luminoso minimo al 80%: 50.000h (L80B10).

**Driver:** incluso.

**Prodotto conforme alle direttive:**

*Gloria LED, downlight with anti-glare panel for flush mounting installations, with recessed adjustable optics  $\pm 30^\circ$  vertical axis and  $255^\circ$  on the front axis, ideal for commercial and residential rooms and in any room where spot and accent lighting without glare is required. Anti-glare panel available in various colours.*

*Product body made of die-cast aluminium painted via powder coating technique and powders with a high degree of purity.*

*The special optics create a rectangular light distribution.*

*The range consists of products with a fixing system using flat springs, or in the trimless version for plasterboard finishing.*

**Installation:** ceiling flush mounting.

**Body:** die-cast aluminium. White painted (RAL 9003) with powder coating technique and powders with a high degree of purity.

**Reflector (not included):** in anti-glare aluminium plated PC, available in various colours.

**Compliant with standard:** EN60598-1, RGO no photobiological risk for the purposes mentioned in standard EN62471.

**COB LED:** maintenance of 80% minimum luminous flux: 50,000h (L80B10).

**Driver:** included.

**Product compliant with directives:**

### LED Gloria QR

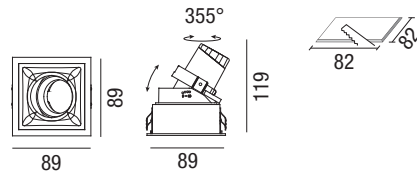

	W max	Lm Output		mA max	K	pcs	Kg	CELL
B	8	800	40°	700	3000	001	0,314	47009NAPO
B	8	800	40°	700	4000	001	0,314	47010NAPO
B	8	800	40°	700	3000	001	0,314	47009DALNAPO
B	8	800	40°	700	4000	001	0,314	47010DALNAPO
B	13	1400	25°	350	3000	001	0,314	47007
B	13	1400	25°	350	4000	001	0,314	47008
B	13	1400	40°	350	3000	001	0,314	47009
B	13	1400	40°	350	4000	001	0,314	47010
B	13	1400	40°	350	3000	001	0,314	47009DALI
B	13	1400	40°	350	4000	001	0,314	47010DALI



Riflettore da ordinare a parte  
Reflector to be ordered separately

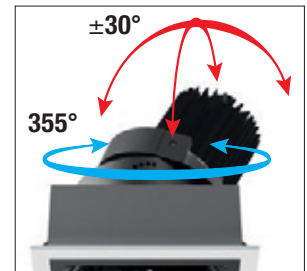

### Tabella di scelta potenza driver LED (incluso) - LED Power supply table choice (included)



Fornito di dip switch per la selezione della tensione in uscita. Il driver incluso nella confezione è normalmente settato alla massima corrente. Se necessario è possibile diminuire la potenza e di conseguenza i lumen output.

*Equipped with dip switch for selecting the voltage output. The driver included inside the package is usually set to max power. If necessary it is possible to decrease the power and consequently the lumen output.*

### Dati fotometrici - Photometric data

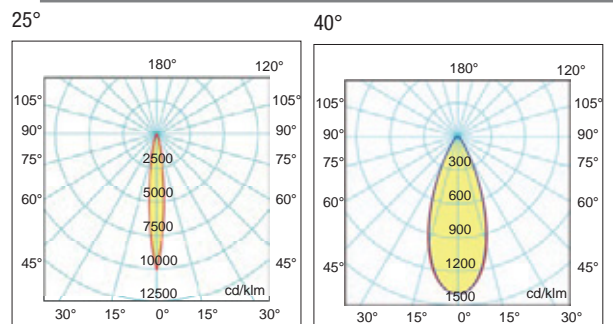

Recessed





## Gesso ceramico

A RICHIESTA  
ON DEMAND

WIRELESS

0-10V

DALI 2



Porta faretto in gesso a scomparsa di forma tonda o quadrata. Un elemento minimale, perfetto in ogni tipologia di ambiente da quello privato a quello pubblico. Istitato nel cartongesso risulta a scomparsa totale, semplice, lineare, moderno ed esteticamente essenziale, tanto da adattarsi alla perfezione a tutti i tipi di progetto. Perfetto per conciliare funzione ed estetica, illumina gli ambienti con eleganza, mettendo in risalto i dettagli. Semplice da installare su parete in cartongesso o laterizio, inserirlo, fare gli opportuni collegamenti e stuccare. Di colore bianco è possibile verniciarlo in tinta con gli interni o in base alle necessità e ai gusti personali.

**Installazione:** incasso a soffitto o a parete come segnapasso.

**Corpo:** ingesso ceramico fortificato.

**Conforme alla norma:** EN60598-1, RG0 nessun rischio fotobiologico ai fini della norma EN62471.

**LED:** mantenimento del flusso luminoso minimo al 80%: 50.000h (L80B10).

**Driver:** incluso (nei codici HD 9043, HD9029).

*Retractable plaster spotlight holder, round or square. A minimal element, perfect in any type of environment, whether private or public. Fitted in plasterboard it totally disappears, being simple, linear, modern and aesthetically essential, so much so that it perfectly fits into any type of design. It wonderfully blends function and aesthetics, lighting up environments with elegance, while highlighting details. Easy to install on plasterboard or brick walls, to insert it, to make the proper connections and to plaster.*

*White colour, it can be painted like the interiors or based on necessity or personal preferences.*

**Installation:** ceiling recessed.

**Body:** die-cast aluminium. Polyester powder coating.

**According to standard:** EN60598-1, RG0 exempt from photo-biological risks in compliance with standard EN62471.

**LED:** maintenance of minimum luminous flux to 80%: 50.000h (L80B10).

**Driver:**  included in Kit.

### Informazioni tecniche di montaggio - Technical assembly information



Avvitare la staffa regolabile per cartongesso spessore da 9~15 mm.

Screw the adjustable bracket for plasterboard, 9-15 mm thick.



Collegare il portalamпада alla rete e alloggiare la lampada nella sede.

Connect the lamp holder to the mains and fit the lamp in its housing.



Assicurare la lampada alla staffa tramite due viti.

Secure the lamp to the bracket with the two screws.



Rasare a filo con gesso per pareti.

Smooth with wall plaster.

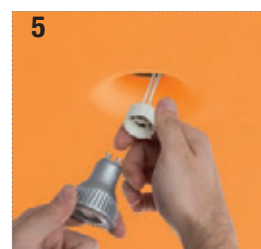

Collegare la lampadina al portalamпада.

Connect the lightbulb to the lamp holder.

# Gesso ceramico da incasso a rasare

## Recessed ceramic plaster to be smoothed

220-240V 50/60Hz 850°

HD 9043

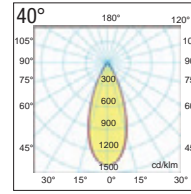
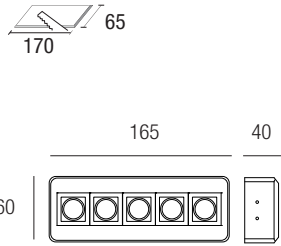
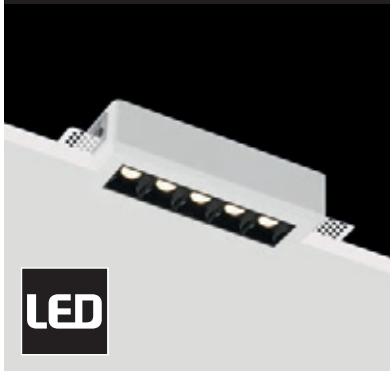

**CRI 90**

colour	W max		Lm Output		K	pcs	Kg	CELL
B	5	5 Led SMD	500	40	3000	001	0,314	HD9043

HD 9029

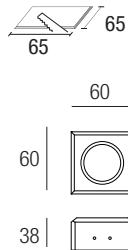
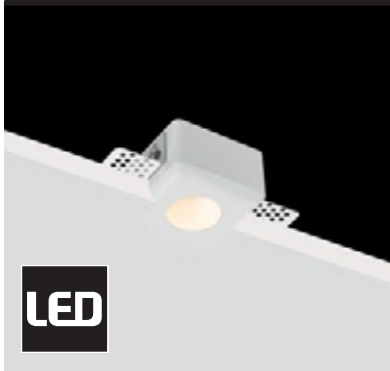

Vetro di protezione temperato  
Tempered safety glass

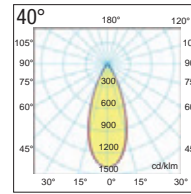

**CRI 90**

colour	W max		Lm Output		K	pcs	Kg	CELL
B	1,5	5 Led SMD	150	40	3000	001	0,314	HD9029

220-240V 50/60Hz 850°

HD 9003

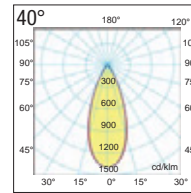
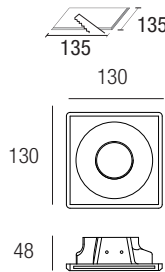

Led GU10 see p.583



colour	W max		Lm Output		K	pcs	Kg	S
B	60	GU10	-	-	-	001	0,314	HD9003

HD 9028/T

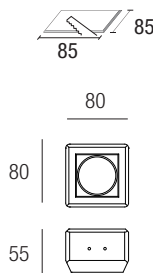

Vetro di protezione temperato  
Tempered safety glass

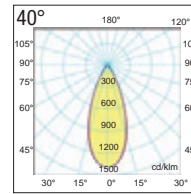

Led GU10 see p.583



colour	W max		Lm Output		K	pcs	Kg	S
B	60	GU10	-	-	-	001	0,314	HD9028/T

Recessed

# Gesso ceramico da incasso a rasare

## Recessed ceramic plaster to be smoothed

220-240V 50/60Hz    **IK07** **IP20**

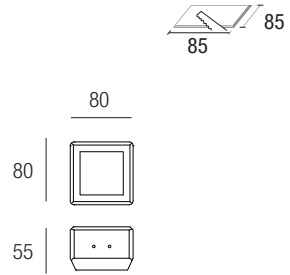

Vetro di protezione temperato  
Tempered safety glass

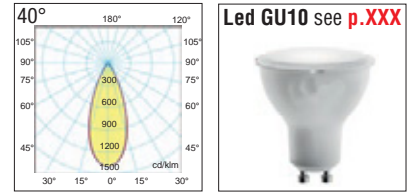
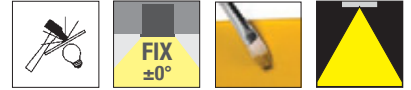

colour	W max		Lm Output		K	pcs	Kg	S
<b>B</b>	60	GU10	-	-	-	001	0,314	HD9028

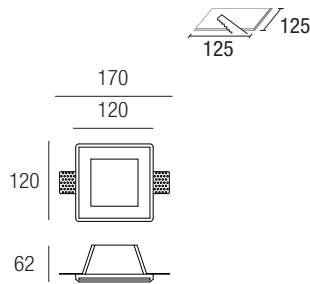

Vetro di protezione temperato  
Tempered safety glass

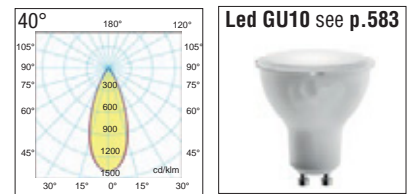
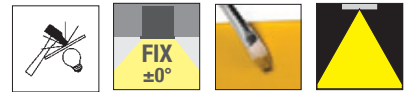

colour	W max		Lm Output		K	pcs	Kg	S
<b>B</b>	60	GU10	-	-	-	001	0,314	HD9001G

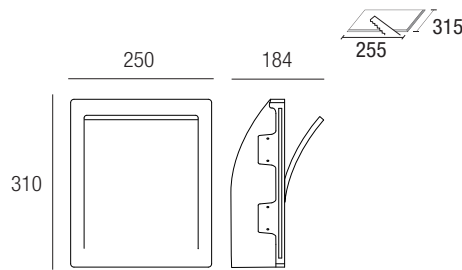

colour	W max		Lm Output		K	pcs	Kg	S
<b>B</b>	60	E14	-	-	-	001	0,314	H8013

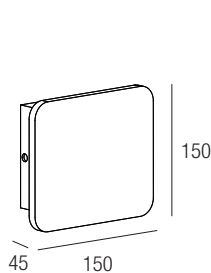

**CRI 90**



Vetro di protezione temperato  
Tempered safety glass



colour	W max		Lm Output		K	pcs	Kg	CELL
<b>B</b>	5,6	5 Led SMD	550	-	3000	001	0,400	HD8540

Recessed

HD 8016

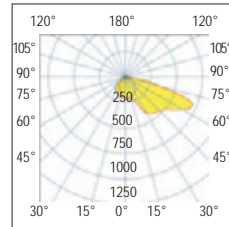
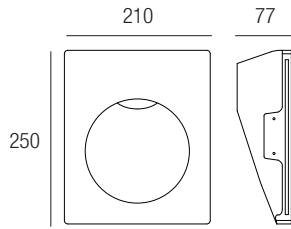

ASY  
Asimmetrica - Asymmetrical



Led GU10 see p.583



colour	W max		Lm Output		K	pcs	Kg	S
B	60	GU10	-	-	-	001	0,314	H8016



Recessed

## LED Imperceptible



A RICHIESTA  
ON DEMAND

1-10V

DALI 2



LED Imperceptible, incassi a LED con ottica arretrata fissa con incasso dal foro minimale ma dall'eccezionale luminosità. Facile installazione della sorgente luminosa tramite innesto a baionetta sui diffusori leggermente arretrati per eliminare l'effetto abbagliante.

Ideale per gli ambienti commerciali, residenziali e in qualsiasi ambiente dove è necessaria un'illuminazione spot e d'accento senza abbagliamento.

Apparecchi efficaci con cornice a base tonda o quadra, singola a due o a tre sorgenti luminose.

**Installazione:** incasso a soffitto su superfici in cartongesso.

**Corpo:** alluminio pressofuso. Verniciatura di tipo poliestere eseguita a polvere bianco RAL 9003.

**Conforme alla norma:** EN60598-1, RG0 nessun rischio fotobiologico ai fini della norma EN62471.

**LED:** CREE mantenimento del flusso luminoso minimo al 80%: 50.000h (L80B10).

**Driver:** incluso, di dimensioni ridotte adatto al passaggio nel foro di Ø38mm dedicato alle ghiera della versione singola o da rasare in cartongesso.

**Driver 1-10V - Dali:** da ordinare a parte, visto le dimensioni estremamente ridotte del foro di incasso deve essere installato remoto.

*LED imperceptible, LED tugs with a fixed fixed optic with recessed by the minimal hole but from the exceptional brightness. Easy installation of the light source via bayonet graft on slightly backward speakers to eliminate the dazzling effect.*

*Ideal for commercial, residential environments and in any environment where spot and emphasis enlightenment is needed without dazzling.*

*Effective devices with round or square -based frame, single with two or three light sources.*

*Installation: ceiling built -in on plasterboard surfaces.*

*Body: die -cast aluminum. Polyester type painting performed with white powder RAL 9003.*

*Compliant with the standard: EN60598-1, RG0 No photobiological risk for the purposes of the EN62471 standard.*

*LED: CREE maintenance of the minimum luminous flux to 80%: 50,000h (L80b10).*

*Driver: Included, small size suitable for the passage in the Ø38mm hole dedicated to the single version or to be shaped in plasterboard.*

*Driver 1-10V - Dali: to be ordered separately, given the extremely small dimensions of the built -in hole must be installed remote.*



Recessed

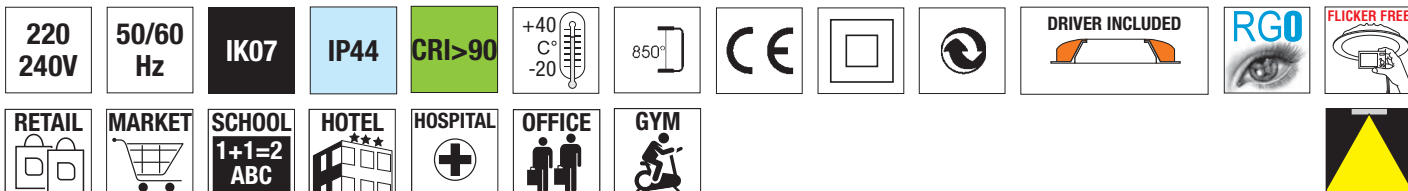

### LED Imperceptible A1



	W max	Lm Output		mA max	K	pcs	Kg	Cell
<input type="checkbox"/> B	10	900	24°	1050	3000	1	0,05	39001/3KW
<input type="checkbox"/> B	10	900	24°	1050	4000	1	0,05	39001/4KW

Colore nero/ Black color **A richiesta/on request**

### LED Imperceptible A2



	W max	Lm Output		mA max	K	pcs	Kg	Cell
<input type="checkbox"/> B	10	900	24°	1050	3000	1	0,05	39002/3KW
<input type="checkbox"/> B	10	900	24°	1050	4000	1	0,05	39002/4KW

Colore nero/ Black color **A richiesta/on request**

### LED Imperceptible A3



	W max	Lm Output		mA max	K	pcs	Kg	Cell
<input type="checkbox"/> B	10	900	24°	1050	3000	1	0,05	39003/3KW
<input type="checkbox"/> B	10	900	24°	1050	4000	1	0,05	39003/4KW

Colore nero/ Black color **A richiesta/on request**

### LED Imperceptible A4



	W max	Lm Output		mA max	K	pcs	Kg	Cell
<input type="checkbox"/> B	10	900	24°	1050	3000	1	0,05	39004/3KW
<input type="checkbox"/> B	10	900	24°	1050	4000	1	0,05	39004/4KW

Colore nero/ Black color **A richiesta/on request**

Recessed

**incasso con cornice in alluminio - *recessed with aluminum frame***

LED Imperceptible A1\*

LED Imperceptible A2

LED Imperceptible A3

LED Imperceptible A4



+



RE-S1



RE-S2



TL-S4



RE-S3

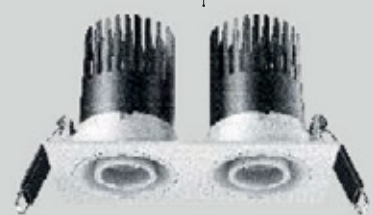
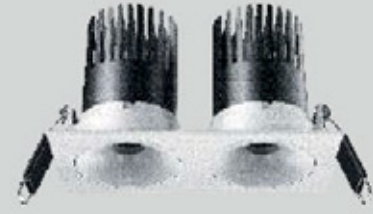
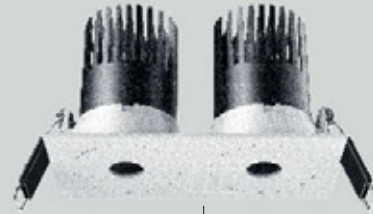
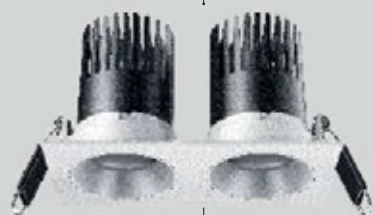

## cornice in plastica per cartongesso a rasare - *plastic frame recessed plasterboard*

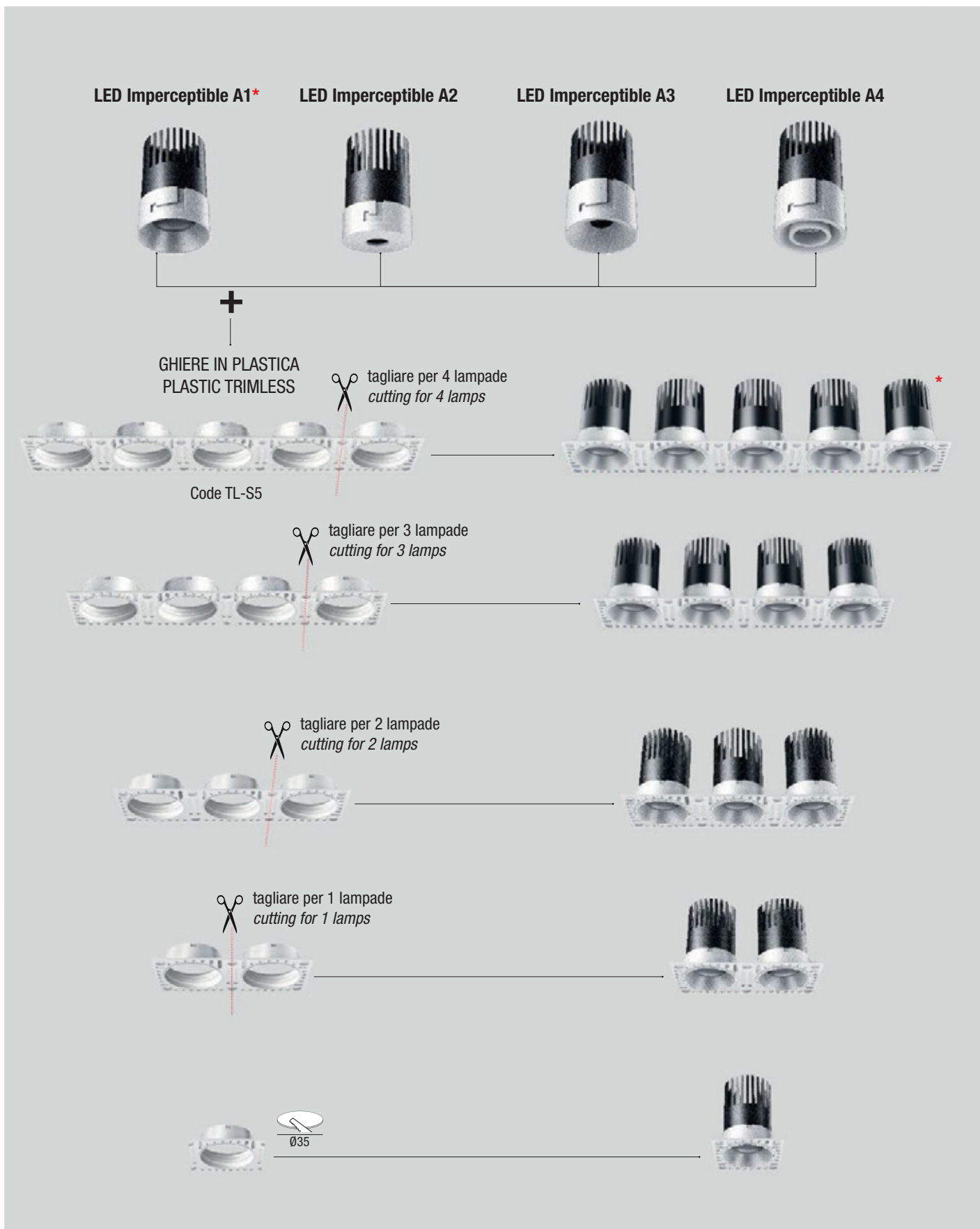

\* Esempio di installazione **LED Imperceptible A1** su ghiera per cartongesso, è possibile utilizzare uno qualsiasi dei 4 modelli.  
La ghiera da 5 moduli (codice TL-S5) può essere tagliata per ottenere moduli da 4, 3, 2 o 1 modulo singolo.  
*Example of **LED Imperceptible A1** installation on plasterboard frames, any of the 4 models can be used.*  
*The 5-module ring (code TL-S5) can be cut to obtain modules of 4, 3, 2 or 1 single module.*



# DOWNLIGHTS Professional

## LED Life 150 - LED Life IP54

A RICHIESTA  
ON DEMAND



Apparecchi ad incasso progettati per illuminare aree comuni, corridoi, laboratori, sale riunioni, uffici, cucine e bagni e qualsiasi ambiente dove è necessaria un'illuminazione con ridotti livelli di abbagliamento. Ideale per luoghi umidi.

**Installazione:** ad incasso per controsoffitti in cartongesso (completo di staffe di fissaggio).

**Corpo e telaio:** in alluminio pressofuso UNI 5076 verniciato con polvere termoisulante poliestere.

**Staffe di fissaggio:** in acciaio nichelato.

**Verniciatura:** di tipo poliestere eseguita a polvere. Colore bianco RAL 9010

**Ottica:** parabola in alluminio diffondente, semi diffondente, concentrante, semi concentrante.

**Schermo:** vetro trasparente (LED Life 150 Cromo, Specchio). Lastra in tecnopolimero opale o trasparente (LED Life 150 Opal), (LED Life Cromo, Opal, Dark light).

**Temperatura di colore:** 3000K - 4000K; altre temperature di colore a richiesta.

**Driver multipotenza:** incluso. Fattore di potenza  $\geq 0,95$ .

**Conforme alla norma:** EN60598-1, RG0 nessun rischio fotobiologico ai fini della norma EN62471.

**Led: SAMSUNG - PHILIPS** mantenimento del flusso luminoso minimo al 80%: 50.000h (L80B10).

**A richiesta:** versione 110V. Prodotto conforme alle direttive:

*Recessed downlights designed to light up common areas, corridors, laboratories, meeting rooms, offices kitchens, bathrooms and any other place that requires diffused lighting with no glare effect. The series consists of recessed fittings with increased protection degree ideal for humid places. The luminaire structure is round, ideal to replace fixtures with compact fluorescent lamps.*

**Installation:** recessed use in plasterboard false ceilings (complete with fixing brackets)

**Body and frame:** made by UNI 5076 die-cast aluminum, coated with polyester thermoset powder.

**Fixing brackets:** made by galvanized steel

**Coating:** coated with powdered polyester. RAL 9010 white color.

**Optic:** semi-diffused, diffused aluminum parabola, clumping or semi clumping.

**Shield:** transparent glass (LED Life 150 Chrome, Mirror). Opal or transparent technopolymer sheet (LED Life 150 Opal), (LED Life Chrome, Opal, Dark light).

**Color temperature:** 3000K - 4000K; other color temperatures available on demand.

**Driver multipower:** included. Power factor  $\geq 0,95$ .

**According to standard:** EN60598-1, RG0 exempt from photo-biological risks in compliance with standard EN62471.

**Led: SAMSUNG - PHILIPS** maintenance of minimum luminous flux to 80%: 50.000h (L80B10).

**On demand:** 110V version. Product compliant with directives:

## LED Life 150 - Opal

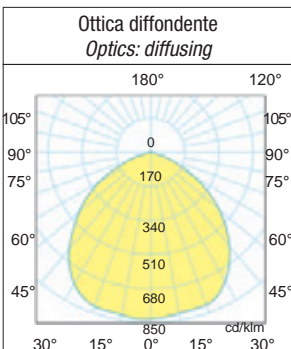
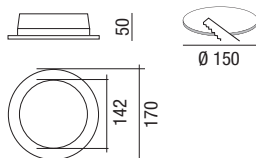

colour	W max	Beam angle	lm output	K	pcs	Kg	CELL
[B]	21	100°	max 2300	3000	001	0.33	2436/3K
<b>0-10V</b>	[B]	100°	max 2300	3000	001	0.33	2436/3K/DIM
<b>DALI 2</b>	[B]	100°	max 2300	3000	001	0.33	2436/3K/DALI
<b>DALI 2 PUSH</b>	[B]	100°	max 2300	3000	001	0.33	2436/3K/DAPU
[B]	21	100°	max 2300	4000	001	0.33	2436
<b>0-10V</b>	[B]	100°	max 2300	4000	001	0.33	2436/DIM
<b>DALI 2</b>	[B]	100°	max 2300	4000	001	0.33	2436/DALI
<b>DALI 2 PUSH</b>	[B]	100°	max 2300	4000	001	0.33	2436/DAPU

## LED Life 150 - Cromo

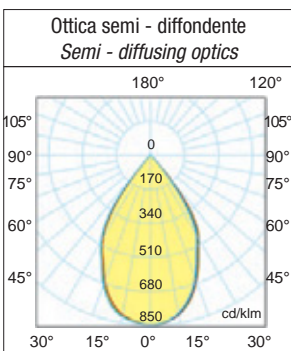
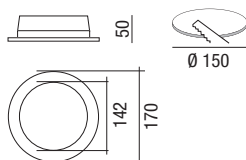
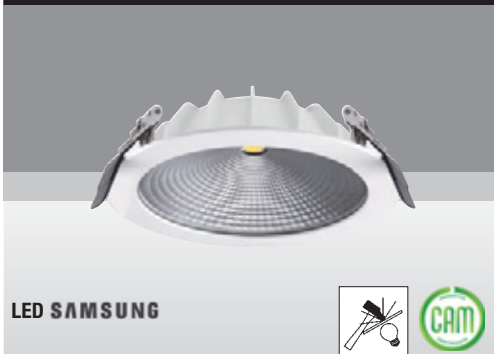

colour	W max	Beam angle	lm output	K	pcs	Kg	CELL
[B]	21	60°	max 2300	3000	001	0.33	2436/CR/3K
<b>0-10V</b>	[B]	60°	max 2300	3000	001	0.33	2436/CR/3KDIM
<b>DALI 2</b>	[B]	60°	max 2300	3000	001	0.33	2436/CR/3K/DA
<b>DALI 2 PUSH</b>	[B]	60°	max 2300	3000	001	0.33	2436/CR/3KDAPU
[B]	21	60°	max 2300	4000	001	0.33	2436/CR
<b>0-10V</b>	[B]	60°	max 2300	4000	001	0.33	2436/CR/DIM
<b>DALI 2</b>	[B]	60°	max 2300	4000	001	0.33	2436/CR/DA
<b>DALI 2 PUSH</b>	[B]	60°	max 2300	4000	001	0.33	2436/CR/DAPU

Recessed

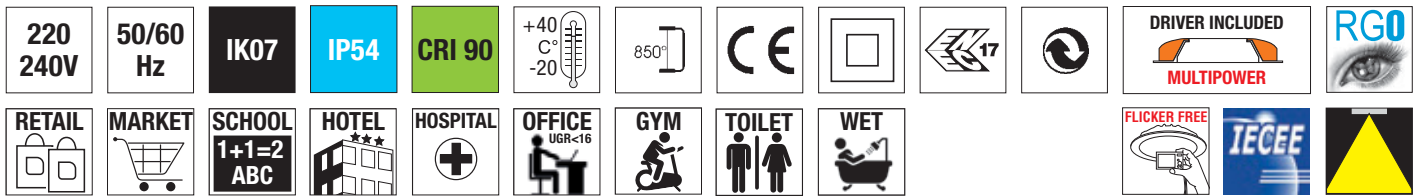

## LED Life 150 - Specchio

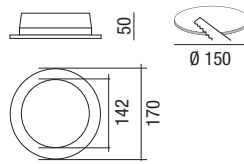

colour	W max	Beam angle	lm output	K	pcs	Kg	CELL
B	21	40°	max 2300	3000	001	0.33	2436/SP/3K
0-10V	B	21	40°	max 2300	3000	001	2436/SP/3KDIM
DALI 2	B	21	40°	max 2300	3000	001	2436/SP/3K/DA
DALI 2 PUSH	B	21	40°	max 2300	3000	001	2436/SP/3K/DAPU
B	21	40°	max 2300	4000	001	0.33	2436/SP
0-10V	B	21	40°	max 2300	4000	001	2436/SP/DIM
DALI 2	B	21	40°	max 2300	4000	001	2436/SP/DA
DALI 2 PUSH	B	21	40°	max 2300	4000	001	2436/SP/DAPU

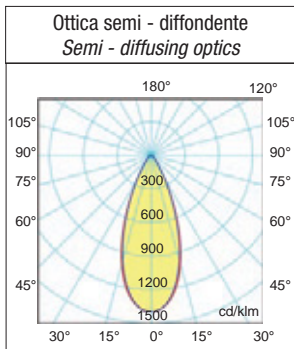

## Accessori non inclusi - Not included accessories



**Anello riduttore a battuta.**  
*Reducer ring (for application against a surface)*  
**Cod. 24398-150**  
Anello riduttore bianco per LED Life 150. È adatto per fori da Ø 150mm a Ø 180mm max.  
*White reduction ring for LED Life 150. It is suitable for hole diameter from Ø 150mm to Ø 180mm max.*

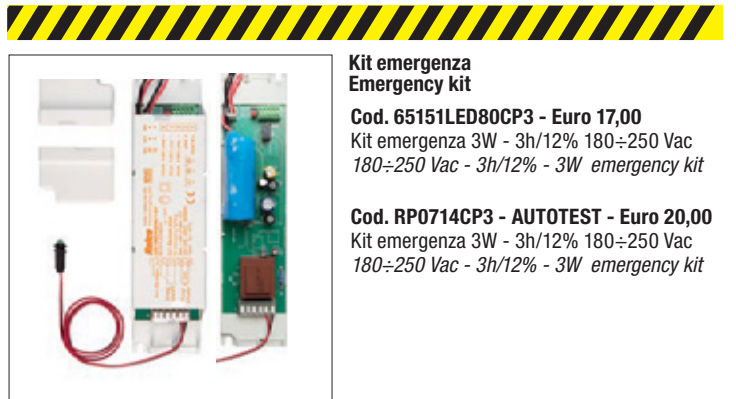

**Kit emergenza**  
*Emergency kit*  
**Cod. 65151LED80CP3 - Euro 17,00**  
Kit emergenza 3W - 3h/12% 180÷250 Vac  
*180÷250 Vac - 3h/12% - 3W emergency kit*  
**Cod. RP0714CP3 - AUTOTEST - Euro 20,00**  
Kit emergenza 3W - 3h/12% 180÷250 Vac  
*180÷250 Vac - 3h/12% - 3W emergency kit*

## Tabella di scelta potenza driver LED (incluso) - LED Power supply table choice (included)



Fornito di dip switch per la selezione della tensione in uscita. Il driver incluso nella confezione è normalmente settato a 21W (vedi tabella). Se necessario è possibile non aumentare la potenza e di conseguenza i lumen output.  
*Equipped with dip switch for selecting the voltage output The driver included inside the package is usually set to 21W (see table). If necessary it is possible to decrease the power and consequently the lumen output.*

Taratura Dip-switch	Potenza Power	Lm Output
mA	Watt	Lm
150	7	770
200	9	990
250	11	1210
300	13	1430
350	15	1650
400	17	1870
450	19	2090
500	21	2300

Taratura standard di fabbrica  
*Driver Standard factory setting*

## LED Life - OPAL

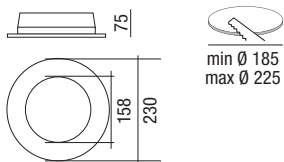

colour	W max	Beam angle	lm output	K	pcs	Kg	CELL
B	30	100°	max 3200	3000	001	0.57	24363/SP/PLUS
B	30	100°	max 3200	4000	001	0.57	24365/SP/PLUS
0-10V B	30	100°	max 3200	3000	001	0.57	24363/30/SP/P
0-10V B	30	100°	max 3200	4000	001	0.57	24365/30/SP/P
DALI 2 B	30	100°	max 3200	3000	001	0.57	24363/30/SPDA
DALI 2 B	30	100°	max 3200	4000	001	0.57	24365/30/SPDA
DALI 2 PUSH B	30	100°	max 3200	4000	001	0.57	2436530SPDAPU

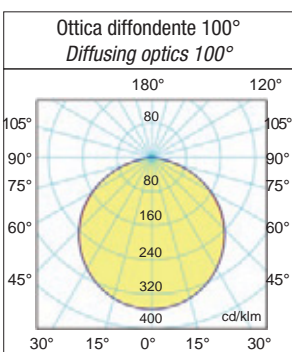

### Tabella di scelta potenza driver LED (incluso) - LED Power supply table choice (included)

Fornito di dip switch per la selezione della tensione in uscita. Il driver incluso nella confezione è normalmente settato a 26W (vedi tabella). Se necessario è possibile aumentare max 30W la potenza e di conseguenza i lumen output.

Equipped with dip switch for selecting the voltage output. The driver included inside the package is usually set to 26W (see table). If necessary it is possible to increase max 30W the power and consequently the lumen output.

Taratura Dip-switch	Potenza Power	Lm Output
mA	Watt	Lm
500	22	2350
600	26	2780
700	30	3200

Taratura standard di fabbrica  
Driver Standard factory setting

## LED Life - Cromo

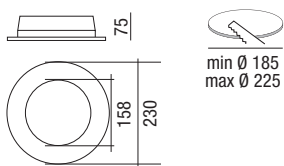

colour	W max	Beam angle	lm output	K	pcs	Kg	CELL
B	30	100°	max 3450	3000	001	0.57	24363/30/DL
B	30	100°	max 3450	4000	001	0.57	24365/30/DL
0-10V B	30	100°	max 3450	4000	001	0.57	24365/30/DLDI
DALI 2 B	30	100°	max 3450	4000	001	0.57	24365/30/DLDA
DALI 2 PUSH B	30	100°	max 3450	4000	001	0.57	2436530DLDAPU

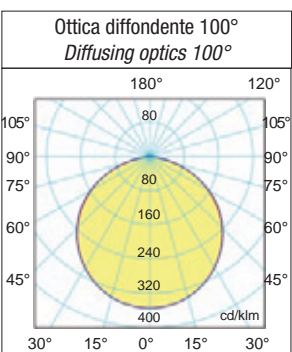

### Accessori non inclusi - Not included accessories



#### Kit emergenza Emergency kit

##### Cod. 65151LED80CP3

Kit emergenza 3W - 3h/12% 180÷250 Vac  
180÷250 Vac - 3h/12% - 3W emergency kit

##### Cod. RP0714CP3 - AUTOTEST

Kit emergenza 3W - 3h/12% 180÷250 Vac  
180÷250 Vac - 3h/12% - 3W emergency kit

## LED Life - Darklight



LED SAMSUNG

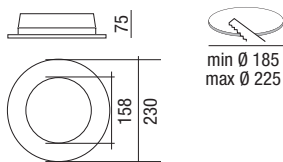

**A richiesta:** versione 3000K (consegna 90gg.)  
**On demand:** 3000K versions (delivery 90 days)

colour	W max	Beam angle	lm output	K	pcs	Kg	CELL
B	30	40°	max 3450	4000	001	0.57	24365/40/DL/N
B	30	60°	max 3450	4000	001	0.57	24365/60/DL/N
0-10V	B	40°	max 3450	4000	001	0.57	2436540DLNDIM
DALI 2	B	40°	max 3450	4000	001	0.57	2436540DLNDA
DALI 2 PUSH	B	40°	max 3450	4000	001	0.57	2436540DLNDAP

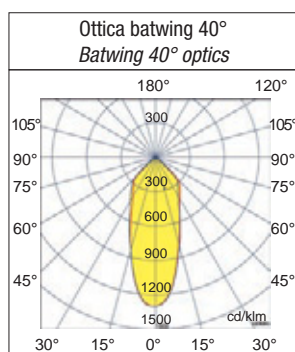

### Tabella di scelta potenza driver LED (incluso) - LED Power supply table choice (included)

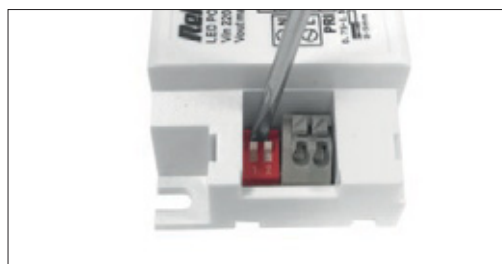

Fornito di dip switch per la selezione della tensione in uscita. Il driver incluso nella confezione è normalmente settato a 26W (vedi tabella). Se necessario è possibile aumentare max 30W la potenza e di conseguenza i lumen output.

*Equipped with dip switch for selecting the voltage output. The driver included inside the package is usually set to 26W (see table). If necessary it is possible to increase max 30W the power and consequently the lumen output.*

Taratura Dip-switch	Potenza Power	Lm Output
mA	Watt	Lm
500	22	2530
600	26	2990
700	30	3450
Taratura standard di fabbrica Driver Standard factory setting		

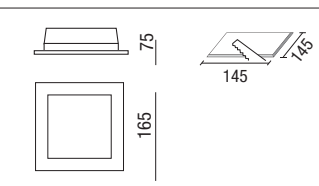
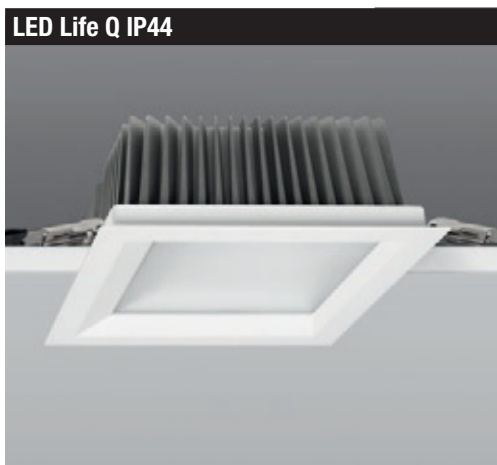

	colour	W max			lm output	K	pcs	Kg	CELL
	B	30	Led SMD	100°	3000	3000	001	0.57	24393
<b>0-10V</b>	B	30	Led SMD	100°	3000	3000	001	0.57	24393/DIM
<b>DALI 2</b>	B	30	Led SMD	100°	3000	3000	001	0.57	24393/DALI
<b>DALI 2 PUSH</b>	B	30	Led SMD	100°	3000	3000	001	0.57	24393/DALIPU
	B	30	Led SMD	100°	3000	4000	001	0.57	24393/4K
<b>0-10V</b>	B	30	Led SMD	100°	3000	4000	001	0.57	24393/4K/DIM
<b>DALI 2</b>	B	30	Led SMD	100°	3000	4000	001	0.57	24393/4K/DALI
<b>DALI 2 PUSH</b>	B	30	Led SMD	100°	3000	4000	001	0.57	24393/4K/DALIPU



**Accessori non inclusi - Not included accessories**

**Kit emergenza  
Emergency kit**

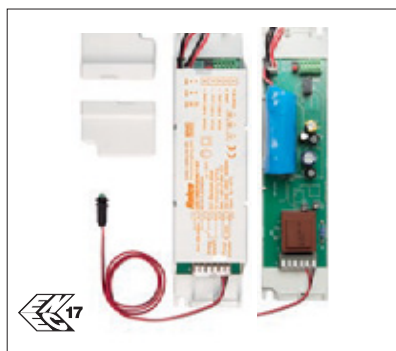

**Cod. 65151LED80CP3**  
Kit emergenza 3W - 3h/12% 180÷250 Vac  
180÷250 Vac - 3h/12% - 3W emergency kit

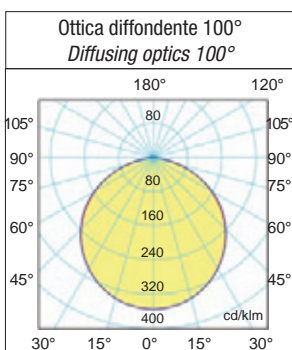

Fornito di dip switch per la selezione della tensione in uscita. Il driver incluso nella confezione è normalmente settato a 26W (vedi tabella). Se necessario è possibile diminuire o aumentare fino a max.30W la potenza e di conseguenza i lumen output.  
Equipped with dip switch for selecting the voltage output The driver included inside the package is usually set to 26W (see table). If necessary it is possible to decrease or increase to max 30W the power and consequently the lumen output.

Taratura Dip-switch	Potenza Power	Lm Output
mA	Watt	Lm
500	22	2100
600	26	2300
700	30	2600

Taratura standard di fabbrica  
Driver Standard factory setting

Recessed

## LED Marian

A RICHIESTA  
ON DEMAND



Downlights progettati per illuminare spazi commerciali (supermercati, grandi magazzini, retail, ecc.), uffici e qualsiasi ambiente dove è necessaria un'illuminazione generale e d'accento.

**Installazione:** ad incasso in controsoffitti di cartongesso (completo di staffe di fissaggio).

**Corpo:** in lamiera di acciaio, verniciata con polvere termoindurente poliestere RAL9010.

**Staffe di fissaggio:** in acciaio.

**Ottica:** semi concentrante 40°, orientabile +15°.

**Temperatura di colore:** 3000K - 4000K.

**Driver:** multipotenza incluso con selezione del dip switch per scegliere la tensione in uscita. Fattore di potenza ≥0,95.

**Conforme alla norma:** EN60598-1, RG0 nessun rischio fotobiologico ai fini della norma EN62471.

**Led:** SAMSUNG mantenimento del flusso luminoso minimo al 80%: 50.000h (L80B10).

*Downlights designed for lighting in shopping malls (supermarkets, department stores, retail stores, etc.), offices and any facility requiring general and accent lighting.*

**Installation:** flush mounting in plasterboard false ceilings (fixing brackets included).

**Body:** in sheet steel, painted with thermo-hardening polyester RAL9010.

**Fastening brackets:** in steel.

**Optics:** semi-clumping 40°, +15° adjustable.

**Colour temperature:** 3000K - 4000K.

**Driver:** Multipower included with dip switch selection to select the output voltage. Power factor ≥0.95.

**Compliant with standard:** EN60598-1, RG0 no photobiological risk for the purposes mentioned in standard EN62471.

**LED:** SAMSUNG maintenance of 80% minimum luminous flux: 50,000h (L80B10).

220-240V 50/60Hz



IK07

IP20

### LED Marian - Orientable



	colour	W			K	Lm	pcs	Kg	CELL
	B	28	1 Led COB	40°	3000	max 3000	001	1.70	24317
<b>0-10V</b>	B	28	1 Led COB	40°	3000	max 3000	001	1.70	24317/DIM
<b>DALI 2</b>	B	28	1 Led COB	40°	3000	max 3000	001	1.70	24317/DAL
<b>DALI 2 PUSH</b>	B	28	1 Led COB	40°	3000	max 3000	001	1.70	24317/DAPU
	B	28	1 Led COB	40°	4000	max 3000	001	1.70	24318
<b>0-10V</b>	B	28	1 Led COB	40°	4000	max 3000	001	1.70	24318/DIM
<b>DALI 2</b>	B	28	1 Led COB	40°	4000	max 3000	001	1.70	24318/DAL
<b>DALI 2 PUSH</b>	B	28	1 Led COB	40°	4000	max 3000	001	1.70	24318/DAPU

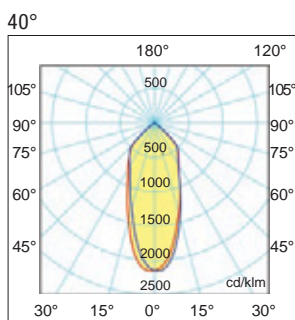

### Tabella di scelta potenza driver LED (incluso) - LED Power supply table choice (included)



Fornito di dip switch per la selezione della tensione in uscita. Il driver incluso nella confezione è normalmente settato a 30W (vedi tabella). Se necessario è possibile diminuire la potenza e di conseguenza i lumen output.

*Equipped with dip switch for selecting the voltage output. The driver included inside the package is usually set to 30W (see table). If necessary it is possible to decrease the power and consequently the lumen output.*

Taratura Dip-switch	Potenza Power	Lm Output
mA	Watt	Lm
500	21	2250
600	25	2650
650	27	2880
700	29	3074
Taratura standard di fabbrica Driver Standard factory setting		

## LED Ardito

Downlights progettati per illuminare spazi commerciali (supermercati, grandi magazzini, retail, ecc.), uffici e qualsiasi ambiente dove è necessaria un'illuminazione generale e d'accento.

**Installazione:** ad incasso in controsoffitti di cartongesso (completo di staffe di fissaggio).

**Corpo:** in lamiera di acciaio, verniciata con polvere termoindurente poliestere.

**Staffe di fissaggio:** in acciaio.

**Verniciatura:** di tipo poliestere eseguita a polvere. Colore bianco RAL 9010

**Ottica:** parabola in alluminio semi concentrante 60°.

**Schermo:** in policarbonato semi-opale.

**Temperatura di colore:** 3000K - 4000K.

**Driver:** multipotenza (non incluso)  con selezione del dip switch per scegliere la tensione in uscita. Fattore di potenza  $\geq 0,95$ .

**Conforme alla norma:** EN60598-1, RG0 nessun rischio fotobiologico ai fini della norma EN62471.

**Led: SAMSUNG** mantenimento del flusso luminoso minimo al 80%: 50.000h (L80B10).

**Prodotto conforme alle direttive:** 

*Downlights designed to light up retail spaces (supermarkets, department stores, shops, etc.), offices and any other place that requires general and spot lighting.*

**Installation:** recessed use in plasterboard false ceilings (complete with fixing brackets).

**Body:** made of sheet steel, painted with polyester thermosetting powder.

**Fixing brackets:** made by steel.

**Coating:** coated with powdered polyester. RAL 9010 white color.

**Optic:** 60° semi-diffused aluminum parabola 0° semi-clumping.

**Shield:** in semi-opal polycarbonate.

**Color temperature:** 3000K - 4000K.

**Driver:** multipower (not included)  with dip switch to choose the output voltage. Power factor  $\geq 0,95$ .

**According to standard:** EN60598-1, RG0 exempt from photo-biological risks in compliance with standard EN62471.

**Led: SAMSUNG** maintenance of minimum luminous flux to 80%: 50.000h (L80B10).

**Product compliant with directives:** 

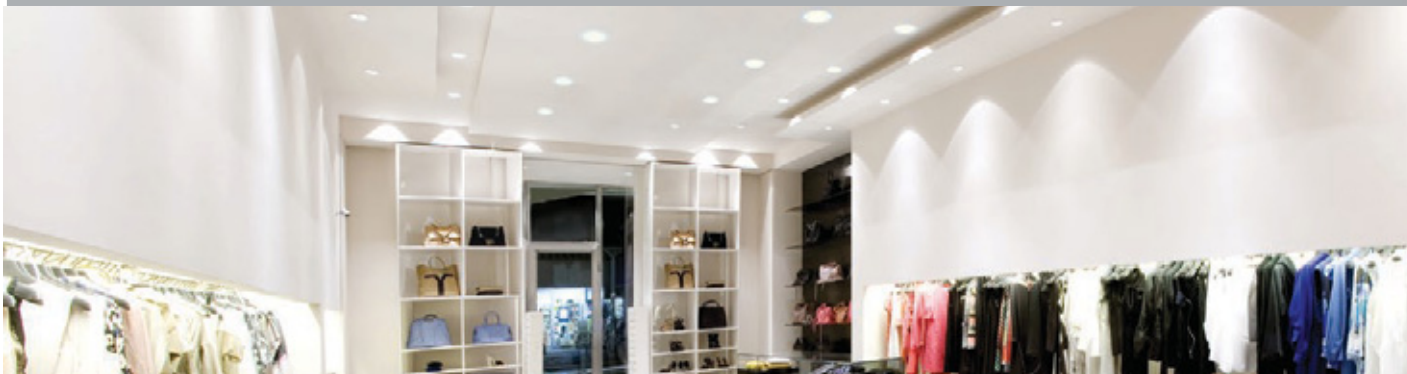
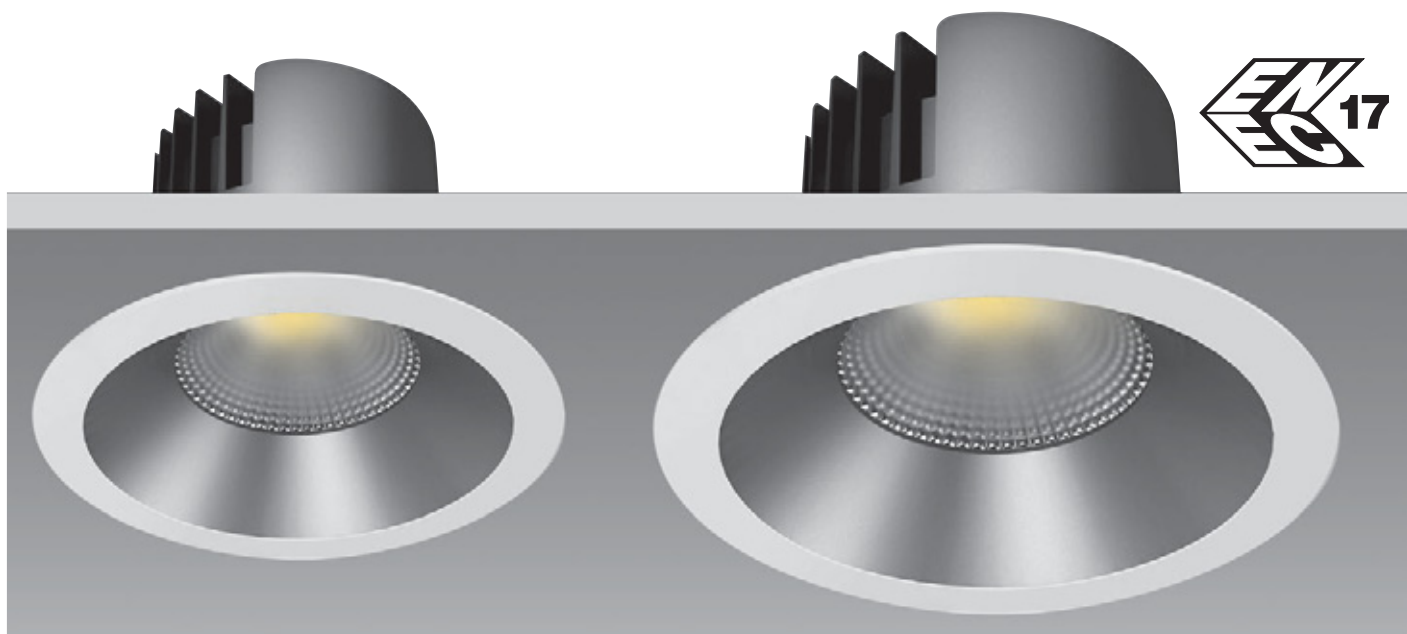

### UGR Indice di abbagliamento - Unified Glare Rating

UGR	Classificazione valori UGR in funzione delle applicazioni. <i>UGR value classification based on application.</i>
≤ 16	<b>Applicazioni molto impegnative</b> (disegni tecnici, lavoro a videoterminale). <b>Highly demanding applications</b> (technical drawings, working with video display terminals).
≤ 19	<b>Uffici e scuole</b> (lettura, scrittura, riunioni). <b>Offices and schools</b> (reading, writing, meetings).
≤ 22	Applicazioni industriali, artigianato. <i>Industrial, artisanal applications.</i>
>28	Abbagliamento elevato. <i>High glare.</i>

L'UGR è l'indicatore dell'abbagliamento diretto derivante dall'impianto di illuminazione. La norma Europea per l'illuminazione dei posti di lavoro in interni **UNI-EN12464-1** richiede un valore UGR specifico per ogni applicazione, compreso tra 10 e 30. Più è basso il valore, minore è l'abbagliamento.

*UGR is the indicator to assess the direct glare coming from a lighting system. The **UNI-EN12464-1** European standard for lighting indoor workplaces requires a specific UGR value for every application, ranging between 10 and 30. The lower the value, the lower the glare.*



A richiesta  
On demand



WIRELESS



IP20 IK06  
IP44 IK06

LED Ardito 150

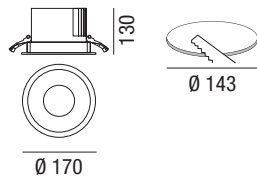

colour	Wmax	△	K	Lm output	pcs	Kg	S+L
B	30	60°	3000	max 3000	001	1.70	24319/150/B
B	30	60°	4000	max 3000	001	1.70	24320/150/B

LED Ardito 200

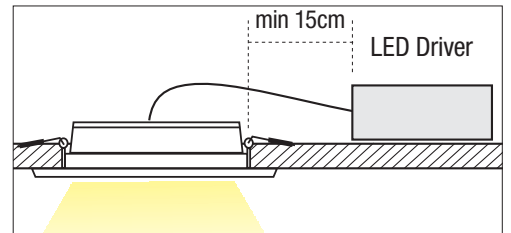
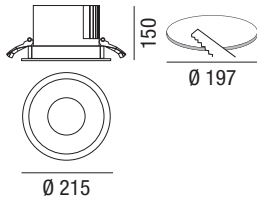

colour	Wmax	△	K	Lm output	pcs	Kg	S+L
B	30	60°	3000	max 3000	001	1.70	24319/200/B
B	30	60°	4000	max 3000	001	1.70	24320/200/B

Tabella di scelta potenza driver LED (non incluso) - LED Power supply table choice (not included)



LED driver multipower

**RN9163 - ON-OFF Taratura max 700mA**

**RN8163DAPU DALI 2 PUSH Taratura max 700mA**

Driver fornito di dip switch per la selezione della tensione in uscita. Il driver è normalmente settato a 30W (vedi tabella). Se necessario è possibile diminuire la potenza e di conseguenza i lumen output.

*Driver Equipped with dip switch for selecting the voltage output The driver is usually set to 30W (see table).*

*If necessary it is possible to decrease the power and consequently the lumen output.*

Taratura Dip-switch	Potenza Power	Lm Output
mA	Watt	Lm
500	21	2100
600	25	2500
650	27	2700
700	30	3000

Taratura standard di fabbrica  
Driver Standard factory setting



Cod. RP0714CP3 - AUTOTEST

L195x P55x H42

Kit emergenza 3W - 3h/12% 180÷250 Vac  
180÷250 Vac - 3h/12% - 3W emergency kit



Cod. 65151LED80CP3

L240x P59x H40

Kit emergenza 3W - 3h/12% 180÷250 Vac  
180÷250 Vac - 3h/12% - 3W emergency kit

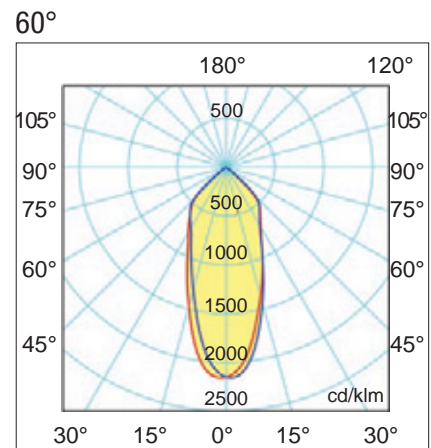

Recessed

## LED Otto IP44

A RICHIESTA  
ON DEMAND



### Otto LED 3 lampade in una!

Apparecchi da incasso progettati per illuminare aree comuni, corridoi, laboratori, sale riunioni, uffici e qualsiasi ambiente dove è necessaria un'illuminazione diffusa. La struttura del faretto è a base tonda, ideale per sostituire apparecchi con sorgenti fluorescenti compatte.

**Installazione:** ad incasso in controsoffitti di cartongesso (completo di staffe di fissaggio).

**Corpo e telaio LED Otto T3 - T4 - T5:** in tecnopolimero ad alta resistenza.

**Staffe di fissaggio e viteria:** in acciaio.

**Verniciatura:** di tipo poliestere eseguita a polvere. Colore bianco RAL 9010.

**Optica:** diffondente.

**Schermo:** in lastra tecnopolimero opale.

**Temperatura di colore:** LED Otto T3 e T4 con possibilità di scelta tra tre diverse temperature di colore, bianco caldo, bianco neutro o bianco freddo, LED Otto T5 3000K o 4000K.

**Driver:** incluso.

**Conforme alla norma:** EN60598-1, RG0 nessun rischio fotobiologico ai fini della norma EN62471.

### Otto LED 3 lamps in one!

Recessed downlights designed to light up common areas, corridors, laboratories, meeting rooms, offices and any other place that requires diffused lighting. The luminaire structure is round, ideal to replace fixtures with compact fluorescent lamps.

**Installation:** recessed use in plasterboard false ceilings (complete with fixing brackets).

**LED Otto T3 - T4 - T5 body and frame:** made by engineering polymer with high resistance.

**Fixing brackets and screws:** made by steel.

**Coating:** coated with powdered polyester. RAL 9010 white color.

**Optic:** diffused.

**Shield:** opal engineering polymer sheet.

**Color temperature:** LED Otto T3 and T4 with the possibility of choosing between three different color temperatures, warm white, neutral white or cold white, LED Otto T5 3000K or 4000K.

**Driver:** included.

**According to standard:** EN60598-1, RG0 exempt from photo-biological risks in compliance with standard EN62471.

220 240V	50/60 Hz	IK07	IP44	CRI>80	+40 C° -20	850°	CE			DRIVER INCLUDED MULTIPOWER	RG0
-------------	-------------	------	------	--------	------------------	------	----	--	--	-------------------------------	-----

### LED Otto T5 Adjustable

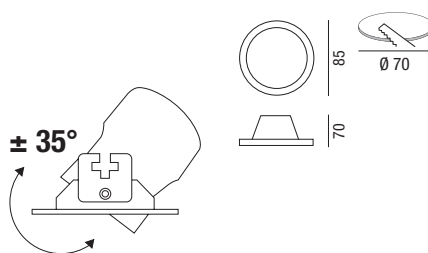

colour	W max	Beam angle	lm output	K	pcs	Kg	CELL
B	9	45°	max 990	3000	001	0.33	24922/3000
B	9	45°	max 990	4000	001	0.33	24922

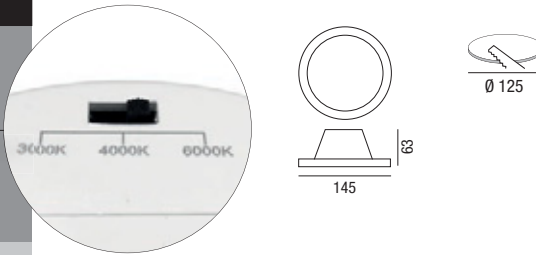

colour	W max	Beam angle	lm output	K	pcs	Kg	CELL
B	12	45°	max 1320	3000	001	0.30	25923/3-4-6K
				6000			

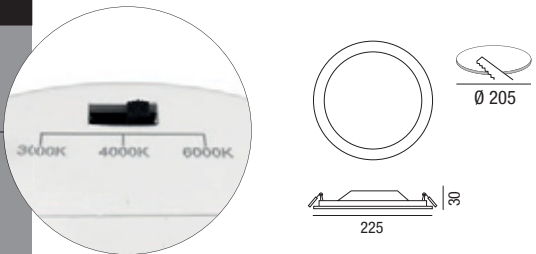

colour	W max	Beam angle	lm output	K	pcs	Kg	CELL
B	25	45°	max 2750	3000	001	0.40	25924/3-4-6K
				6000			

**Accessori non inclusi - Not included accessories**

Otto LED T4 accessorio per plafone  
Otto LED T4 ceiling accessory

Colour	pcs	H. mm	Ø mm	Code
B	001	33	230	25924/PL

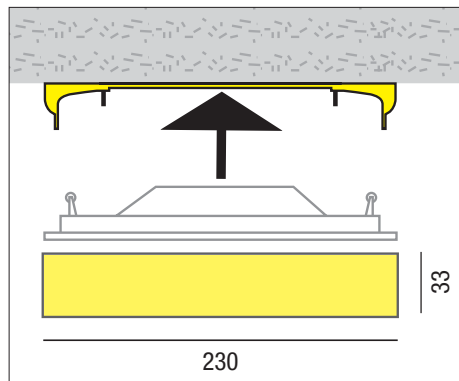

**Cod. 65151LED80CP3 (9W - 12W)**  
Kit emergenza 3W - 3h/12% 180÷250 Vac  
180÷250 Vac - 3h/12% - 3W emergency kit

**Cod. RP0714CP3 + 00PB0530-N / AUTOTEST (25W)**  
Kit emergenza 3W - 3h/12% 180÷250 Vac  
180÷250 Vac - 3h/12% - 3W emergency kit

## LED Nove C-R IP44

**NEW**

A RICHIESTA  
ON DEMAND

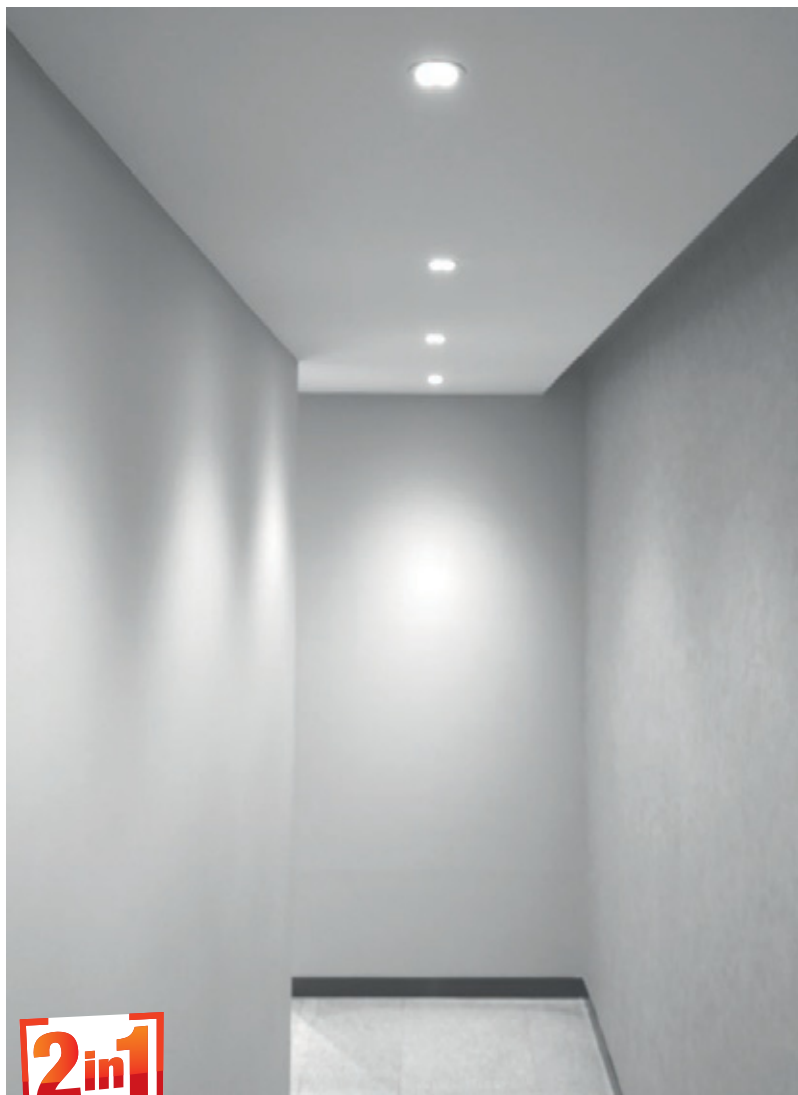

### LED Nove 6 lampade in una!

Plafoniere da incasso o plafone "Super Slim" 3CCT con possibilità di scelta tra tre differenti potenze, progettate per illuminare aree comuni, corridoi, laboratori, sale riunioni, uffici e qualsiasi ambiente dove è necessaria un'illuminazione diffusa. La struttura dei faretti è a base tonda, in 3 misure, ideali per sostituire apparecchi con sorgenti fluorescenti compatte, fornito di staffe scorrevoli in acciaio con molle che si adattano a fori già esistenti da da Ø65 a Ø310mm.

**Installazione:** a plafone, incasso in controsoffitti di cartongesso (complete di staffe di fissaggio che si adattano a fori di diversi diametri da Ø65 a Ø310mm) e sospensione con accessori inclusi.

**Corpo e telaio:** in tecnopolimero ad alta resistenza.

**Staffe di fissaggio e viteria:** in acciaio.

**Verniciatura:** di tipo poliestere eseguita a polvere. Colore bianco RAL 9010.

**Ottica:** diffondente.

**Schermo:** in lastra tecnopolimero opale.

**Cornici:** in metallo, magnetiche di colore Bianco, Nero, Nikel (da ordinare a parte).

**Temperatura di colore:** con possibilità di scelta tra tre diverse temperature di colore, bianco caldo, bianco neutro o bianco freddo.

**Driver:** incluso.

**Conforme alla norma:** EN60598-1, RG0 nessun rischio fotobiologico ai fini della norma EN62471.

### LED Nove 6 lamps in one!

3CCT "Super Slim" recessed or surface-mounted ceiling lights with the possibility of choosing between three different powers, designed to illuminate common areas, corridors, laboratories, meeting rooms, offices and any environment where diffused lighting is required.

The structure of the spotlight has a round base, ideal for replacing fixtures with compact fluorescent sources, supplied with sliding steel brackets with springs that adapt to existing holes from Ø65 to Ø310mm.

**Installation:** surface mounted, recessed in plasterboard false ceilings (complete with fixing brackets that adapt to holes of different diameters from Ø65 to Ø310mm) and suspended with accessories included.

Body and frame: in high resistance technopolymer.

**Fixing brackets and screws:** in steel.

**Painting:** polyester type made with powder. RAL 9010 white colour.

**Optics:** diffusing.

**Screen:** in opal technopolymer plate.

**Frames:** in metal, magnetic in White, Black, Nikel (to be ordered separately).

**Color temperature:** with the choice of three different color temperatures, warm white, neutral white or cool white.

**Drivers:** included.

**Compliant with standard:** EN60598-1, RG0 no photobiological risk for the purposes of standard EN62471.

**2in1**

soffitto e  
incasso  
ceiling or  
recessed

Montaggio a soffitto  
Surface-mounted

Montaggio ad incasso  
Recessed-mounted

Super sottile  
Super slim



17 mm

Cornici non incluse  
not included Frames



Code: 001Black - Ø 225mm  
Code: 002Black - Ø 330mm

Code: 001Silver - Ø 225mm  
Code: 002Silver - Ø 330mm

Cornice bianca inclusa  
White frame included





### LED Nove C-R 225

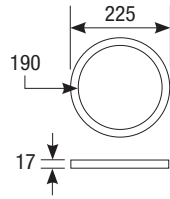

Staffe adattabili per Ø 225 - Ø 225 Adaptable brackets

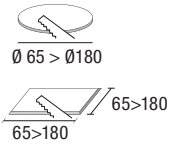
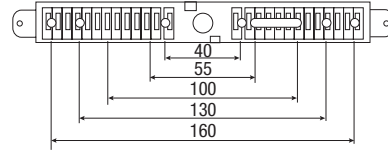

colour	W		lm output	K			pcs	Kg	CELL
B	6	120°	480	3000	4000	6500	001	0.30	NOVE-18
	12		960						
	18		1440						

### LED Nove C-R 330

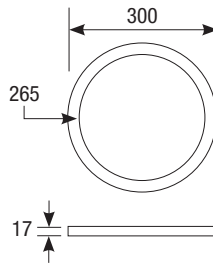

Staffe adattabili per Ø 300 - Ø 300 Adaptable brackets

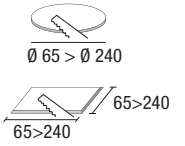
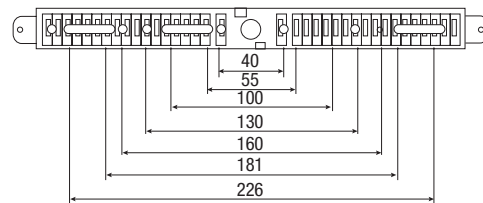

colour	W		lm output	K			pcs	Kg	CELL
B	20	120°	1600	3000	4000	6500	001	0.45	NOVE-28
	24		1920						
	28		2380						

### Accessori inclusi - Included accessories

Foro quadrato  
Square Hole



Ø225mm - 65>180 mm.  
Ø330mm - 65>240 mm.

Foro tondo  
Round Hole



Ø225mm - Ø 65 > Ø180 mm.  
Ø330mm - Ø 65 > Ø240 mm.

Molle scorrevoli  
Slidable springs

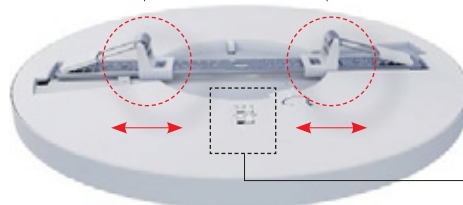

**6in1**

3CCT - COLOR CHANGEABLE  
3K 4K 6K

POWER CHANGEABLE  
W W W

## LED Bazar

A RICHIESTA  
ON DEMAND



Apparecchi ad incasso progettati per illuminare aree comuni, corridoi, laboratori, sale riunioni, uffici e qualsiasi ambiente dove è necessaria un'illuminazione con ridotti livelli di abbagliamento.

**Installazione:** ad incasso per controsoffitti in cartongesso (completo di staffe di fissaggio).

**Corpo e telaio:** in lamiera di acciaio con faretto orientabili e basculanti.

**Staffe di fissaggio:** in acciaio nichelato.

**Verniciatura:** di tipo poliestere eseguita a polvere. Colore bianco RAL 9010

**Ottica:** parabola in alluminio diffondente.

**Temperatura di colore:** 3000K - 4000K.

**Driver multipotenza:** incluso.

Fattore di potenza  $\geq 0,95$ .

**Conforme alla norma:** EN60598-1, RG0 nessun rischio fotobiologico ai fini della norma EN62471.

**Led:** **SAMSUNG** mantenimento del flusso luminoso minimo al 80%: 50.000h (L80B10).

*Recessed downlights designed to light up common areas, corridors, laboratories, meeting rooms, offices and any other place that requires diffused lighting with no glare effect.*

**Installation:** recessed use in plasterboard false ceilings (complete with fixing brackets)

**Body and frame:** in sheet steel with adjustable and tilting spotlights.

**Fixing brackets:** made by galvanized steel.

**Coating:** coated with powdered polyester.

**RAL 9010 white color.**

**Optic:** semi-diffused.

**Color temperature:** 3000K - 4000K.

**Driver multipower:** included.

Power factor  $\geq 0,95$ .

**According to standard:** EN60598-1, RG0 exempt from photo-biological risks in compliance with standard EN62471.

**Led:** **SAMSUNG** maintenance of minimum luminous flux to 80%: 50.000h (L80B10).



### LED Bazar 1X25

**NEW**

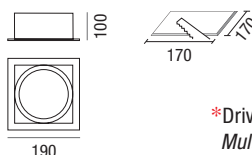
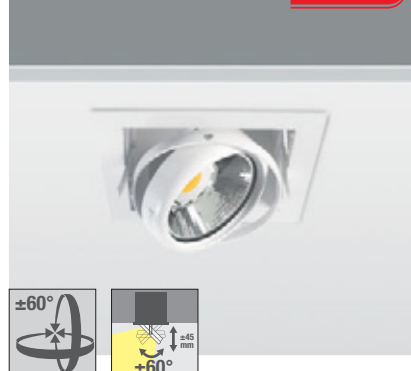

\*Driver multipotenza incluso, è possibile se necessario, ridurre i Lm Output.  
Multipower driver included, it is possible if necessary, to reduce the Lm Output.

	colour	W max*	K	Lm output			pcs	Kg	CELL
	B	25	3000	2750	40°	25° - 60°	10	1.50	BZ125403K
	B	25	3000	2750	40°	25° - 60°	10	1.50	BZ125403KDA
	B	25	4000	2750	40°	25° - 60°	10	1.50	BZ125404K
	B	25	4000	2750	40°	25° - 60°	10	1.50	BZ125404KDA

### LED Bazar 1X40

**NEW**

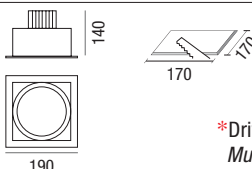

\*Driver multipotenza incluso, è possibile se necessario, ridurre i Lm Output.  
Multipower driver included, it is possible if necessary, to reduce the Lm Output.

	colour	W max*	K	Lm output			pcs	Kg	CELL
	B	40	3000	4400	40°	25° - 60°	10	1.50	BZ140403K
	B	40	3000	4400	40°	25° - 60°	10	1.50	BZ140403KDA
	B	40	4000	4400	40°	25° - 60°	10	1.50	BZ140404K
	B	40	4000	4400	40°	25° - 60°	10	1.50	BZ140404KDA

### A richiesta - On request

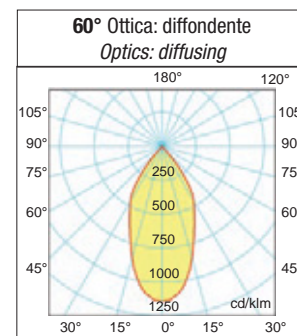
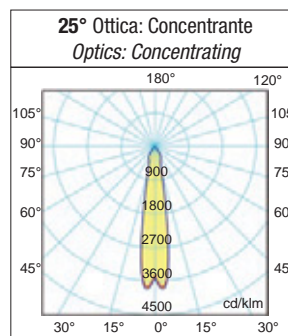
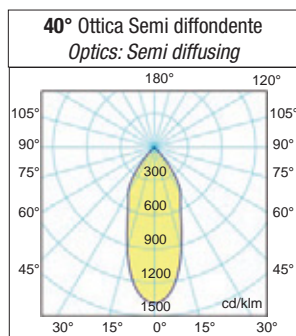

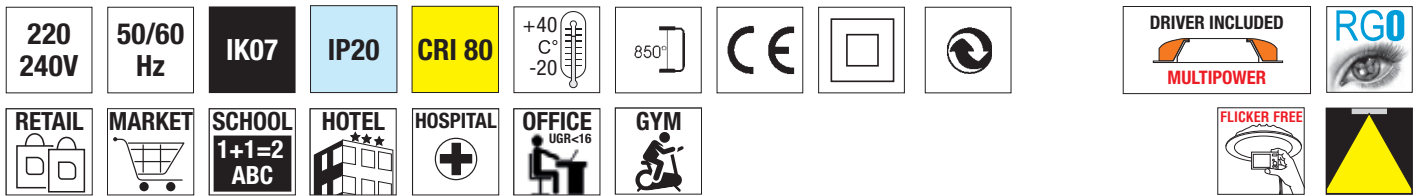

### LED Bazar 2x25

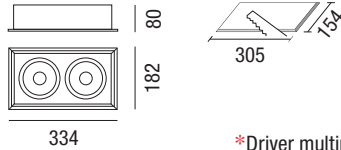

\*Driver multipotenza incluso, è possibile se necessario, ridurre i Lm Output.  
*Multipower driver included, it is possible if necessary, to reduce the Lm Output.*

colour	W max*	Beam angle	on demand	lm output	K	pcs	Kg	CELL
B	2x25	40°	25° - 60°	max 5000	3000	001	2	BZ225403K
<b>DALI 2</b>	B	2x25	40°	25° - 60°	max 5000	3000	001	BZ225403KDA
B	2x25	40°	25° - 60°	max 5000	4000	001	2	BZ225404K
<b>DALI 2</b>	B	2x25	40°	25° - 60°	max 5000	4000	001	BZ225404KDA

### LED Bazar 2x40

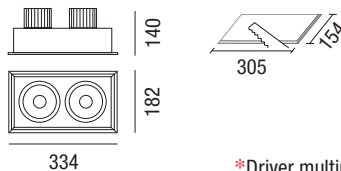

\*Driver multipotenza incluso, è possibile se necessario, ridurre i Lm Output.  
*Multipower driver included, it is possible if necessary, to reduce the Lm Output.*

colour	W max*	Beam angle	on demand	lm output	K	pcs	Kg	CELL
B	2x40	40°	25° - 60°	max 8000	3000	001	2,5	BZ240403K
<b>DALI 2</b>	B	2x40	40°	25° - 60°	max 8000	3000	001	BZ240403KDA
B	2x40	40°	25° - 60°	max 8000	4000	001	2,5	BZ240404K
<b>DALI 2</b>	B	2x40	40°	25° - 60°	max 8000	4000	001	BZ240404KDA

### A richiesta - On request



**Cod. 65151LED80CP3**  
 Kit emergenza 3W - 3h/12% 180÷250 Vac  
 180÷250 Vac - 3h/12% - 3W emergency kit

### Driver LED incluso - Included LED Power supply



Fornito di dip switch per la selezione della corrente in uscita. Se necessario diminuire (NO AUMENTARE) la potenza e di conseguenza i lumen output.

**Equipped with dip switch for selecting the current output. If necessary, decrease (NO INCREASE) the power and consequently the lumen output.**



### Accessorio non incluso - Not included accessory

Accessorio cassaforma esterna per montaggio a soffitto, lo spazio è idoneo per alloggiare il Driver compreso con la lampada.

*External formwork accessory for ceiling mounting, the space is suitable for housing the Driver included with the lamp.*

Cod. CBZ1



Cod. CBZ2



## LED Horo

A RICHIESTA  
ON DEMAND



Apparecchi ad incasso progettati per illuminare sale riunioni, uffici, cucine e qualsiasi ambiente dove è necessaria un'illuminazione potente e direzionabile.

L'utilizzo della tecnologia LED garantisce una resa luminosa elevata in relazione al consumo di energia, annullando i costi di manutenzione con un notevole risparmio economico.

**Installazione:** ad incasso per controsoffitti in cartongesso (completo di staffe di fissaggio).

**Corpo e telaio:** in alluminio pressofuso UNI 5076 verniciato con polvere termoindurente, poliestere.

**Orientabilità:** il corpo è estraibile ed orientabile su due assi, rispettivamente di  $Z=355^\circ$ ,  $Y=60^\circ$ .

**Staffe di fissaggio:** in acciaio nichelato.

**Verniciatura:** di tipo poliestere eseguita a polvere. Colore bianco RAL 9003, nero RAL 9005.

**Ottica:** parabola in alluminio.

**Schermo:** lastra in tecnopolimero trasparente.

**Temperatura di colore:** 3000K; altre temperature di colore a richiesta.

**Driver multipotenza:**  non incluso. Fattore di potenza  $\geq 0,95$ .

**Conforme alla norma:** EN60598-1, RG0 nessun rischio fotobiologico ai fini della norma EN62471.

**Led: SAMSUNG - PHILIPS** mantenimento del flusso luminoso minimo al 80%: 50.000h (L80B10).

**Prodotto conforme alle direttive:** 

*Recessed downlights designed to light up common areas, meeting rooms, offices kitchens, and any other place that requires diffused lighting powerful and directional.*

*The use of LED technology ensures a high lighting performance related to energy consumption, thus eliminating maintenance costs and allowing significant cost savings.*

**Installation:** recessed use in plasterboard false ceilings (complete with fixing brackets)

**Body and frame:** made by UNI 5076 die-cast aluminum, coated with polyester thermoset powder.

**Adjustability:** Pull-out light Head pivot through  $Y=60^\circ$ , rotates through  $Z=355^\circ$ .

**Fixing brackets:** made by galvanized steel

**Coating:** coated with powdered polyester.

RAL 9003 white color or RAL 9005 black color.

**Optic:** aluminum parabola.

**Shield:** transparent engineering polymer sheet.

**Color temperature:** 3000K; other color temperatures available on demand.

**Driver multipower:**  not included. Power factor  $\geq 0,95$ .

**According to standard:** EN60598-1, RG0 exempt from photobiological risks in compliance with standard EN62471.

**Led: SAMSUNG - PHILIPS** maintenance of minimum luminous flux to 80%: 50.000h (L80B10).

**Product compliant with directives:** 



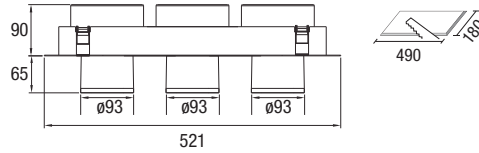
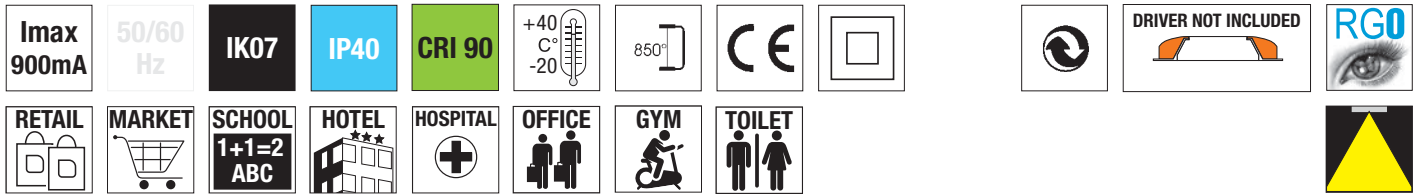

colour	W max	I max	lm output max	K	pcs/pallets	Kg	S+L
<b>N</b>	3x32	900 mA	3x3840	3000	60	5.00	32940
<b>B</b>	3x32	900 mA	3x3840	3000	60	5.00	32941
<b>N</b>	3x32	900 mA	3x3840	4000	60	5.00	32940/4K
<b>B</b>	3x32	900 mA	3x3840	4000	60	5.00	32941/4K

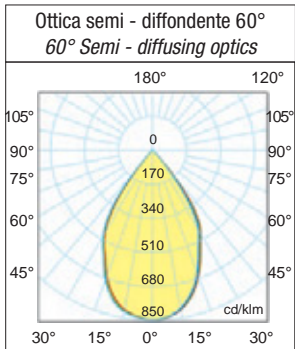

**Accessori non inclusi - Not included accessories**



LED driver multipower   
**RN9164/FAST (ON-OFF)**  
**RN9164-1-10VF (0-10V)**  
**RN9168/DAFAST (DALI, PUSH, 0-10V)**  
**RN9182DAPUFAS (DALI2 PUSH)**



**Cod. 65151LED80CP3**  
 Kit emergenza 3W - 3h/12% 180÷250 Vac  
 180÷250 Vac - 3h/12% - 3W emergency kit

**Cod. RP0714CP3 - AUTOTEST**  
 Kit emergenza 3W - 3h/12% 180÷250 Vac  
 180÷250 Vac - 3h/12% - 3W emergency kit

**Tabella di scelta potenza driver LED - LED Power supply table choice**

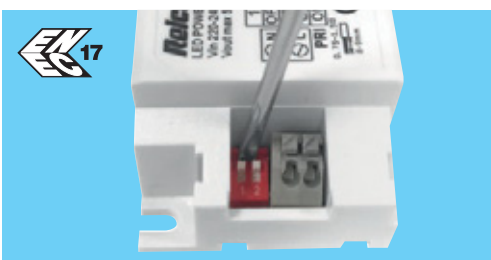

Fornito di dip switch per la selezione della corrente in uscita. Il driver incluso nella confezione è normalmente settato a 32W (vedi tabella). Se necessario è possibile diminuire la potenza e di conseguenza i lumen output.  
**Equipped with dip switch for selecting the current output. The driver included inside the package is usually set to 32W (see table). If necessary it is possible to decrease the power and consequently the lumen output.**

Taratura Dip-switch	Potenza Power	Lm Output
mA	Watt	Lm
700	25	3x3000
800	28	3x3360
900	32	3x3840
Taratura standard di fabbrica Driver Standard factory setting		

# LINEAR RECESSED Professional



Serie di apparecchi a LED lineari da incasso in diverse misure, dalle dimensioni più compatte per creare giochi di luce di grande effetto a dimensioni più ampie con schermo opale per illuminare in maniera omogenea supermarket, palestre oppure con schermo dark light con UGR<16 per uffici, reception. Facilmente installabile anche in linea continua tramite gli accessori di giunzione (non inclusi). Collegamento rapido con morsetto fast.

Disponibili in versione DALI, 0-10V.

**Installazione:** ad incasso.

**Corpo:** alluminio estruso anodizzato.

**Ottica:** in policarbonato opale.

**Ottica dark Light:** parabola in alluminio 99,85, antiriflesso UGR<16 e antiridescente a bassissima luminanza.

**Conforme alla norma:** EN60598-1, RG0 nessun rischio fotobiologico ai fini della norma EN62471.

**Led:** PCB con LED Samsung SMD 3528 o Seoul semiconductor, mantenimento del flusso luminoso minimo al 80%: 50.000h (L80B10).

**Driver:** non incluso > 50.000 h  Fattore di potenza ≥0,95.

**Prodotto conforme alle direttive:** 

*Straight LED fixtures with compact dimensions for flush mounting with opal screen, for common areas, offices, reception areas, supermarkets, gyms, which can be easily installed in a continuous line by means of the junction accessories for continuous lines (not included), quick connection with fast terminal. Available in DALI version, 0-10V.*

**Installation:** recessed.

**Body:** anodised extruded aluminium.

**Optics:** in opal polycarbonate.

**Dark light optics:** 99.85 aluminium parabola, antiglare UGR<16 and anti-iridescent, with very low luminance.

**Compliant with standard:** EN60598-1, RG0 no photobiological risk for the purposes mentioned in standard EN62471.

**Led:** PCB with LED Samsung SMD 3528 or Seoul semiconductor, maintenance of 80% minimum luminous flux: 50,000h (L80B10).

**Driver:** not included > 50,000h  Power factor ≥0.95.

**Product compliant with directives:** 

**Syros slim system R - Dark Light**  
L.1200 x P. 115mm.

**Syros slim system R - Opal**  
L.1200 x P. 115mm.

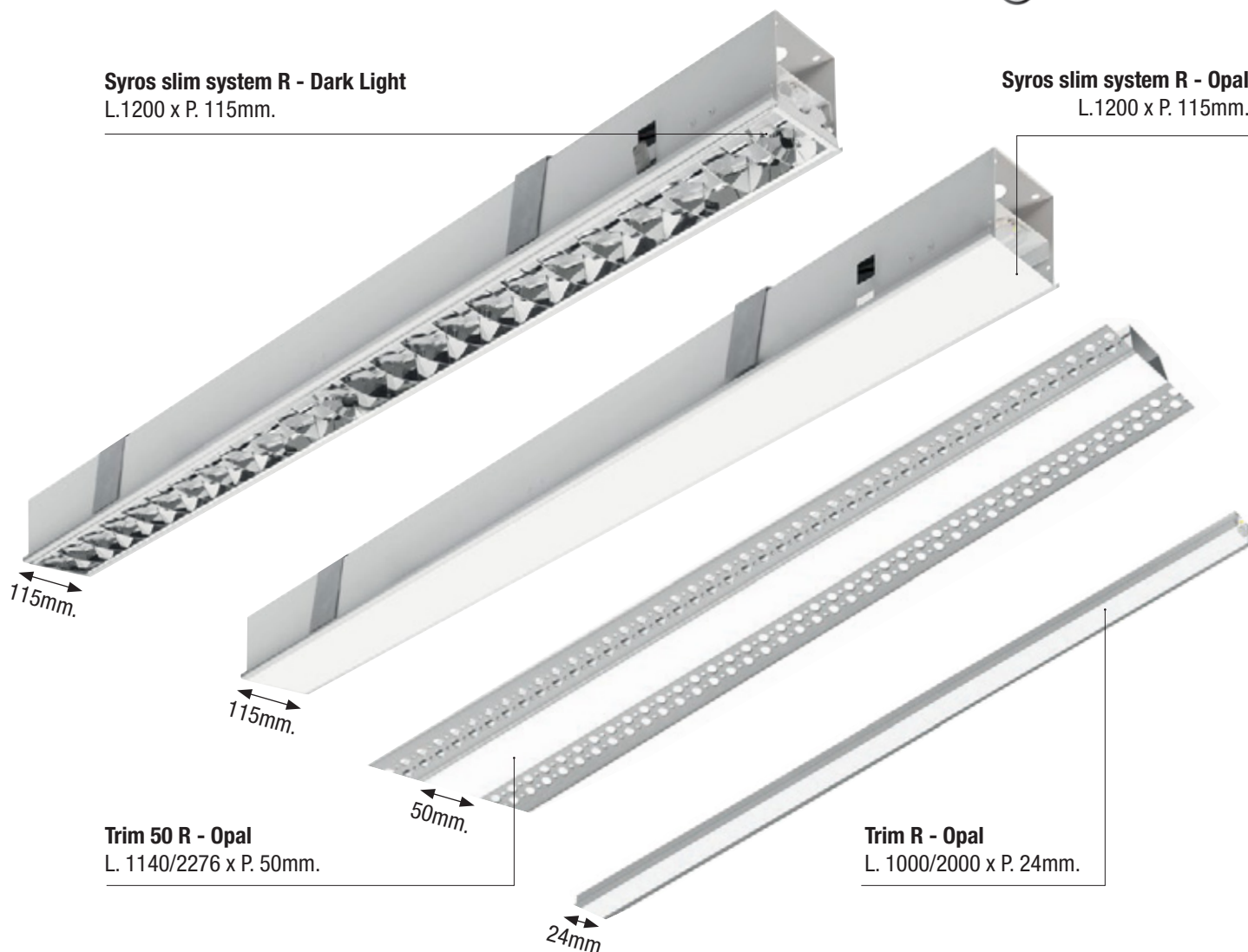

**Trim 50 R - Opal**  
L. 1140/2276 x P. 50mm.

**Trim R - Opal**  
L. 1000/2000 x P. 24mm.

# LINEAR RECESSED Professional

## LED Trim R Opal

Apparecchio singolo e fila continua  
Single devices and continuous line

A richiesta  
On demand



### LED Trim R Opal

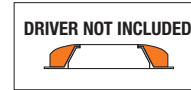
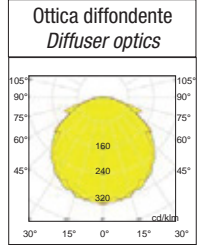
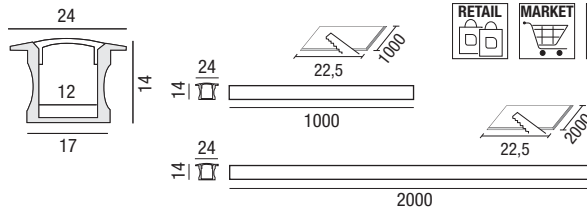
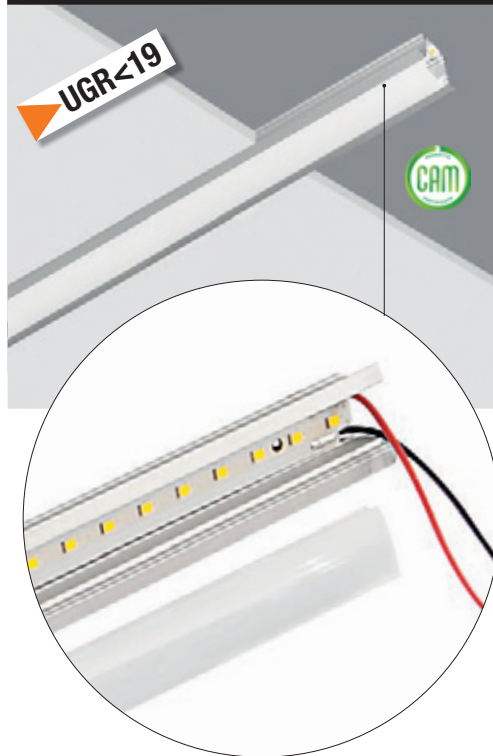

colour	W max	IP	Imax	Im	K	L [mm]	Kg	?	S+L
S	20	20	950 mA	2300	4000	1000	0.185	5 pcs	20070-1/PLUS
S	20	20	950 mA	2300	3000	1000	0.185	5 pcs	20070-1/PLUS3
S	40	20	950 mA	4600	4000	2000	0.370	5 pcs	20070-2/PLUS
S	40	20	950 mA	4600	3000	2000	0.370	5 pcs	20070-2/PLUS3

La confezione include 5 pezzi, il prezzo è riferito ad una singola lampada.  
The package includes 5 pieces, the price refers to a single lamp.

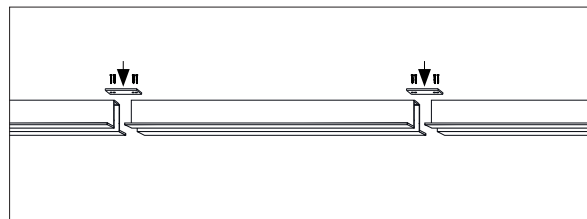

Possibilità di collegamento in linea continua tramite l'accessorio Kit giunto lineare **incluso nella confezione.**  
Possibility of series connection to create a continuous row using the accessory linear joint kit **included in the packaging.**

### Esempio applicativo - Application example

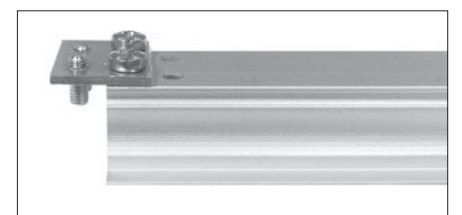

**Incluso di:** molle di fissaggio in lamiera di acciaio zincata e giunto lineare (2pcs) in lamiera di acciaio zincata, che permette di realizzare una giunzione di due corpi illuminanti in fila continua (fissaggio con viti).

**Included:** fixing springs kit in galvanised steel sheet, Linear coupler kit (2 pcs) in galvanised steel sheet, fixing with screws. It allows a junction to be created, of two lighting fixtures in a continuous row.

### Accessori non inclusi - Not included accessories

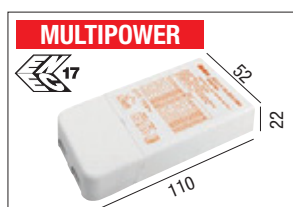

**JOLLY KLEIN 20**  
power: max. 950 mA  
Cod. RN9161

**JOLLY KLEIN 20 DIM**  
power: max. 950 mA  
Cod. RN9160

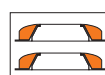
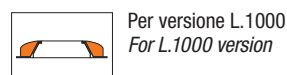

**DRIVER:**  
**DALI 2 PUSH**  
RN9182

Per versione L.2000  
For L. 2000 version



**Cod. 20070/T**  
**Kit tappi di chiusura (2pcs)**  
In materiale termoplastico.  
**Closure caps kit (2pcs)**  
Thermoplastic material.

# LED Trim 50 R Opal

Apparecchio singolo e fila continua  
*Single devices and continuous line*

A richiesta  
*On demand*



Recessed

# LINEAR RECESSED Professional



LED Trim 50 R Opal

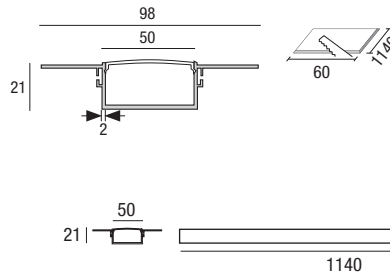
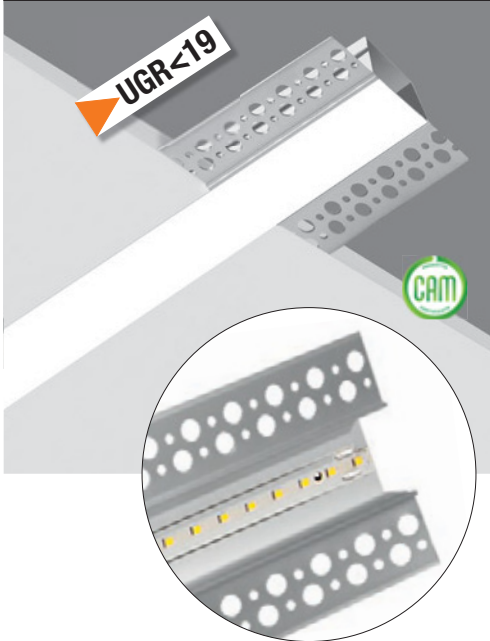

**CRI 90**

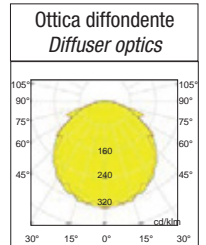

colour	W max	IP	I <sub>max</sub>	l <sub>m</sub>	K	Kg		S+L
S	40	20	950 mA	4600	4000	0.185	5 pcs	20073-5/PLUS
S	40	20	950 mA	4600	3000	0.185	5 pcs	20073-5/PLUS3



## Accessori non inclusi - Not included accessories

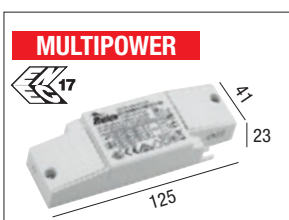

ICE LED  
power: max. 950 mA  
Cod. RN9164

DIM 1-10Vdc  
ICE LED  
power: max. 950 mA  
Cod. RN9164-1-10V

DALI 2 PUSH  
JOLLY DALI 2  
power: max. 700 mA  
Cod. RN9182DAPUSH



Cod. 20073/C  
(2pcs)  
Kit giunto lineare a scomparsa  
In lamiera di acciaio zincato,  
fissaggio con viti.  
**Retractable linear coupler kit**  
In galvanised steel sheet,  
fixing with screws.

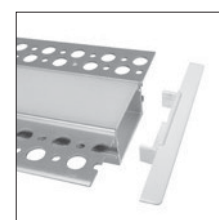

Cod. 20073/T  
(2pcs)  
Kit tappi di chiusura  
In materiale termoplastico  
Bianco RAL 9010  
**Closure caps kit**  
Thermoplastic material  
white RAL 9010

## Syros slim system R

Apparecchio singolo e fila continua  
*Single devices and continuous line*

A RICHIESTA  
ON DEMAND

0-10V

DALI 2

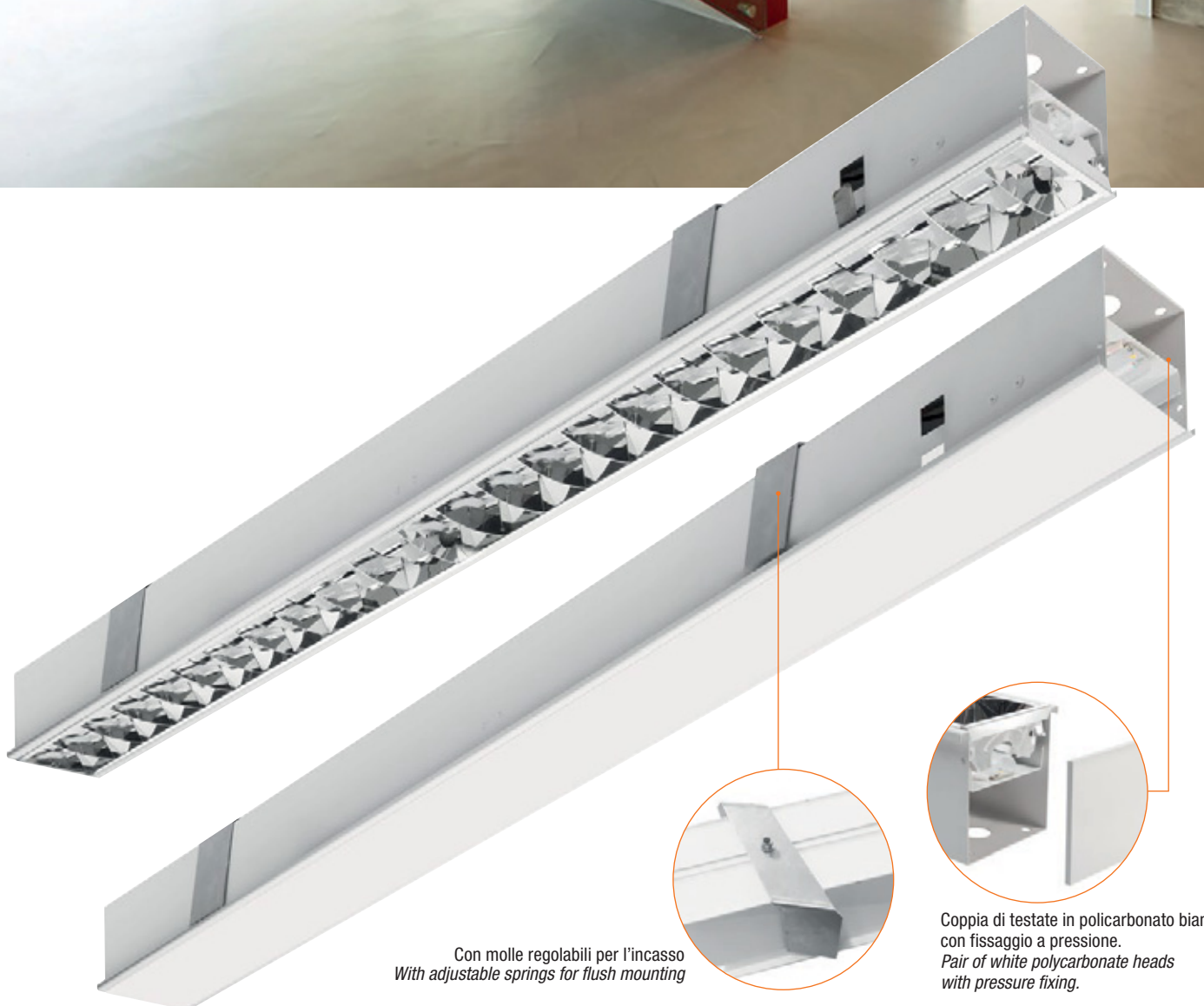

Con molle regolabili per l'incasso  
*With adjustable springs for flush mounting*

Coppia di testate in policarbonato bianco  
con fissaggio a pressione.  
*Pair of white polycarbonate heads  
with pressure fixing.*

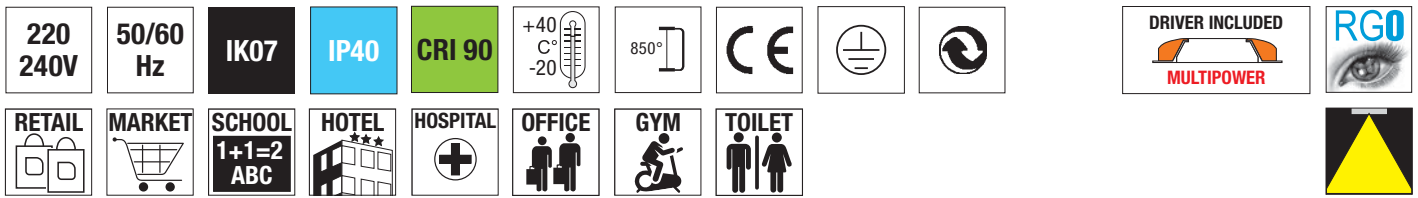

### Syros slim system R - Dark light

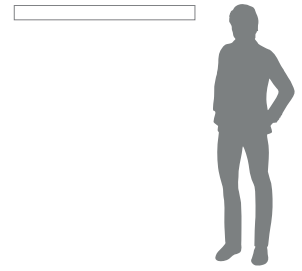
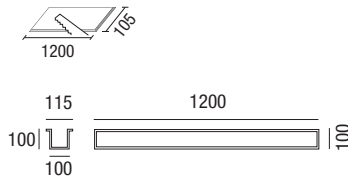
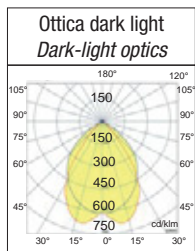

	colour	W max	Vac	lm output	lm/W	K	pcs/pallets	Kg	CELL
	B	40	220-240	5100	127	4000	60	4.50	25933/SL
<b>0-10V</b>	B	40	220-240	5100	127	4000	60	4.50	25933/SL/DIM
<b>DALI 2 PUSH</b>	B	40	220-240	5100	125	4000	60	4.50	25933/SL/DALI
	B	60	220-240	7200	120	4000	60	4.50	25934/SL
<b>0-10V</b>	B	60	220-240	7200	120	4000	60	4.50	25934/SL/DIM
<b>DALI 2 PUSH</b>	B	60	220-240	7200	120	4000	60	4.50	25934/SL/DALI
	B	85	220-240	10100	126	4000	60	4.50	25935/SL
<b>0-10V</b>	B	85	220-240	10100	126	4000	60	4.50	25935/SL/DIM
<b>DALI 2 PUSH</b>	B	85	220-240	10100	126	4000	60	4.50	25935/SL/DALI

**EMERGENCY** Per lampade cablate in emergenza (aggiungere /EM dopo il codice) sovrapprezzo del 20%.  
For wired emergency lights (add /EM after the code) 20% extra charge.

### Syros slim system R - Opal

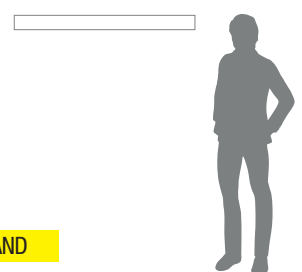
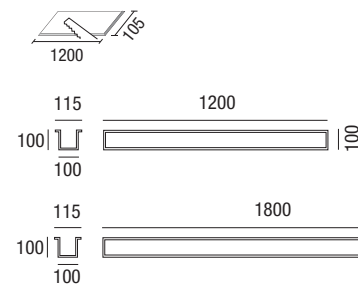
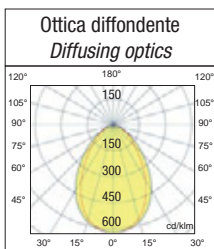

	colour	W max	Vac	lm output	lm/W	K	pcs/pallets	Kg	CELL
	B	40	220-240	5100	127	4000	60	4.50	25940/SL
<b>0-10V</b>	B	40	220-240	5100	127	4000	60	4.50	25940/SL/DIM
<b>DALI 2 PUSH</b>	B	40	220-240	5100	125	4000	60	4.50	25940/SL/DALI
	B	60	220-240	7200	120	4000	60	4.50	25942/SL
<b>0-10V</b>	B	60	220-240	7200	120	4000	60	4.50	25942/SL/DIM
<b>DALI 2 PUSH</b>	B	60	220-240	7200	120	4000	60	4.50	25942/SL/DALI
	B	85	220-240	10100	126	4000	60	4.50	25943/SL
<b>0-10V</b>	B	85	220-240	10100	126	4000	60	4.50	25943/SL/DIM
<b>DALI 2 PUSH</b>	B	85	220-240	10100	126	4000	60	4.50	25943/SL/DALI

**EMERGENCY** Per lampade cablate in emergenza (aggiungere /EM dopo il codice) sovrapprezzo del 20%.  
For wired emergency lights (add /EM after the code) 20% extra charge.

Recessed

# Syros slim system R installazione - *installation*

3S Syros slim system R - Incasso / recessed

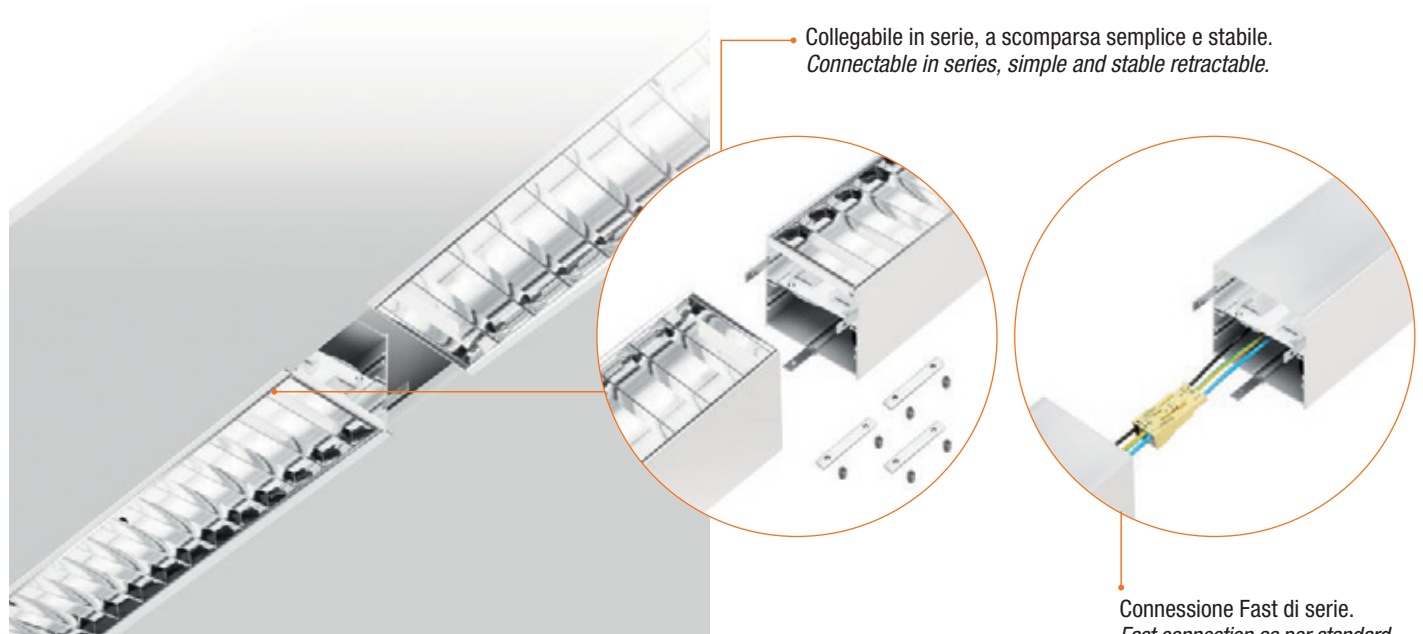
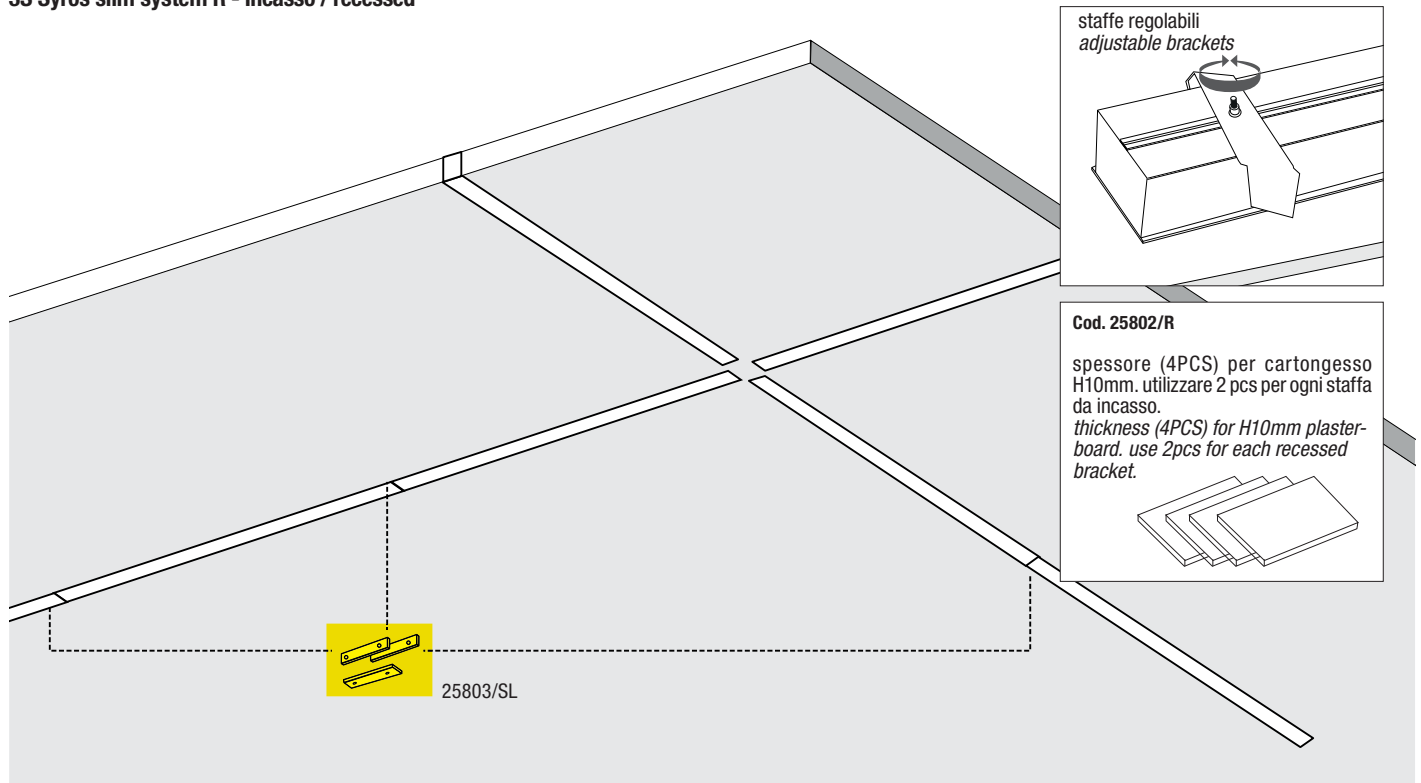

## Accessori non inclusi - *Not included accessories*

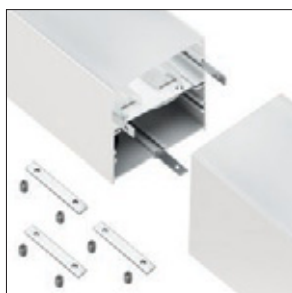
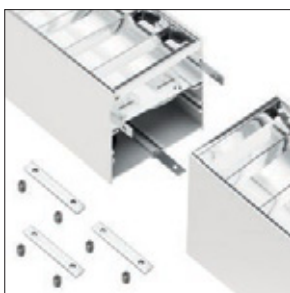

**Cod. 25803/SL**  
**Kit giunto lineare a scomparsa (3pcs)**  
In lamiera di acciaio zincato, fissaggio con viti.

**Retractable linear coupler kit (3pcs)**  
In galvanised steel sheet, fixing with screws.

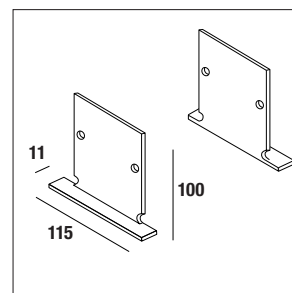

**Cod. 25804/Endcaps**  
**Testate terminali (2pcs)**  
In lamiera di acciaio zincato, fissaggio con viti.

**End caps (2pcs)**  
In galvanised steel sheet, fixing with screws.



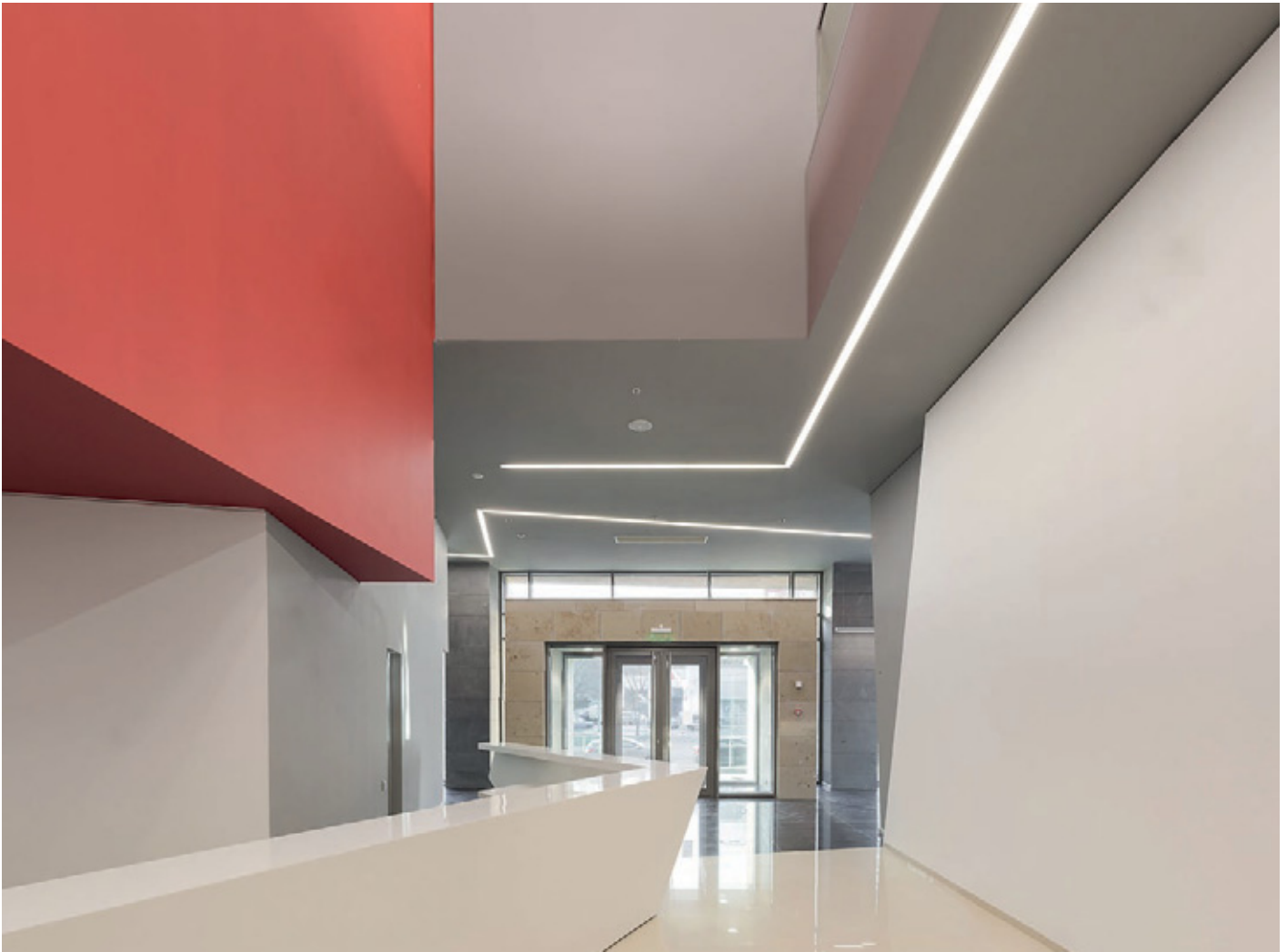

**Recessed**

## LEDresswall R

A RICHIESTA  
ON DEMAND



Apparecchio a LED **UGR<19** per un elevato confort visivo con un bassissimo indice di abbagliamento, in sostituzione retrofit di lampade fluorescenti installate su controsoffitti a doghe o su cartongesso. Ideale laddove è richiesta un'illuminazione con livelli di abbagliamento minimi come uffici ed Enti pubblici. Il bassissimo consumo energetico e le contenute temperature garantiscono una lunga durata al prodotto. L'utilizzo della tecnologia LED garantisce una resa luminosa elevata in relazione al consumo di energia, annullando completamente i costi di manutenzione. Alimentatore integrato per alimentazioni on/off e Dali, disponibile a richiesta il modulo in emergenza.

**Installazione:** retrofit su doghe in metallo o cartongesso (a richiesta), con elementi di giunzione per linee continue e accessori a richiesta, per angoli a "L" "X" e "T".

**Corpo:** in alluminio verniciato bianco RAL 9010.

**Ottica:** diffusore in policarbonato opale o prismato UGR<19.

**Temperatura di colore:** warm white 3000K o natural white 4000K.

**Driver multipotenza** : non incluso.

Con possibilità di diminuzione della potenza (Lm) tramite DIP. Fattore di potenza  $\geq 0,95$ .

**Conforme alla norma:** EN60598-1, RG0 nessun rischio fotobiologico ai fini della norma EN62471.

**Led:** SMD Mantenimento del flusso luminoso minimo al 80%: 50.000h (L80B10).

*LED fixture with **UGR<19** for high visual comfort with a very low glare index, replacing retrofit of fluorescent lamps installed on strip of slats aluminum or plasterboard. Ideal where light is required with minimal glare levels such as offices and public buildings. Very low energy consumption and low temperatures guarantee a long product life. LED technology guarantees high light output in relation to energy consumption, completely eliminating maintenance costs.*

*Integrated power supply for on / off and Dali power supplies, the emergency module available on request.*

**Installation:** retrofit for fluorescent lamps on slats aluminum, with junction elements for continuous lines and accessories on request, for "L" "X" and "T" corners.

**Body:** in white painted aluminum RAL 9010.

**Optic:** diffuser in opal or prismatic polycarbonate UGR <19.

**Color temperature:** warm white 3000K o natural white 4000K.

**Multipower driver** : not included.

*With possibility of decreasing power (Lm) by means of DIP switch. Power factor  $\geq 0.95$ .*

**According to standard:** EN60598-1, RG0 no photobiological risk for the purposes mentioned in standard EN62471.

**Led:** SMD Maintenance of 80% minimum luminous flux: 50,000h (L80B10).

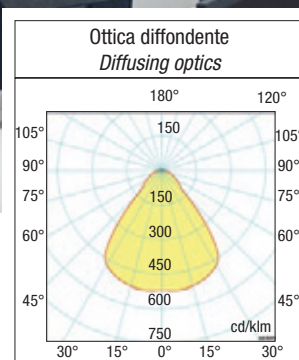

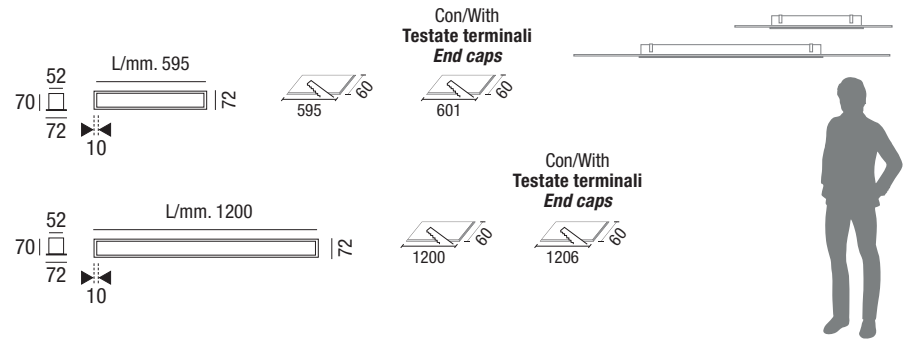

colour	W max	mA max	Vac	lm output	lm/W	K	L [mm]	Kg	S+L
B	15	350	220-240	1950	130	3000	595	2.20	25889/603K
B	15	350	220-240	1950	130	4000	595	2.20	25889/604K
B	27	700	220-240	3900	130	3000	1200	4.40	25889/1203K
B	27	700	220-240	3900	130	4000	1200	4.40	25889/1204K

Per la versione con molle di fissaggio per cartongesso aggiungere M dopo il codice  
 For the version with fixing springs for plasterboard, add M after the code

**Accessori non inclusi - Not included accessories**



LED driver multipower   
 RN9152 - ON-OFF Taratura 350mA per 600mm  
 RN9163 - ON-OFF Taratura 650mA per 1200mm  
 RN9182DAPU (DALI2 PUSH)  
 Taratura 350mA per 600mm, 650mA per 1200mm

LEDresswall R600		
RN9152 RN9182DAPU	Potenza Power	Lm Output
mA	Watt	Lm
150	7	910
200	9	1170
250	11	1430
300	13	1690
350	15	1950

Taratura driver consigliata  
 Driver calibration recommended

LEDresswall R1200		
RN9163 RN9182DAPU	Potenza Power	Lm Output
mA	Watt	Lm
500	21	2730
600	25	3250
650	27	3900

Taratura driver consiglia  
 Driver calibration recommended



**Cod. 65151LED80CP3**  
 L240x P59x H40  
 Kit emergenza 3W - 3h/12% 180÷250 Vac  
 180÷250 Vac - 3h/12% - 3W emergency kit

**Cod. RP0714CP3 - AUTOTEST**  
 L195x P55x H42  
 Kit emergenza 3W - 3h/12% 180÷250 Vac  
 180÷250 Vac - 3h/12% - 3W emergency kit

Recessed-ceiling-suspended

**Cod. LSXXXXSPJT**

**Kit di giunzione scomparsa (2pcs)**

In lamiera di acciaio zincato, fissaggio con viti.

**splicing kit (2pcs)**

In galvanised steel sheet, fixing with screws.

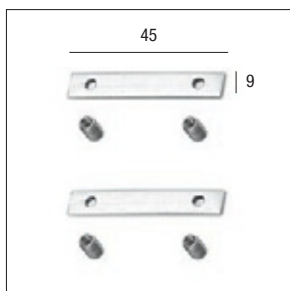
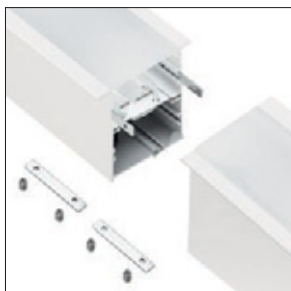

**Cod. 7270S-L**

**Kit congiunzione a L non luminoso**  
**L-shaped connection kit not bright**

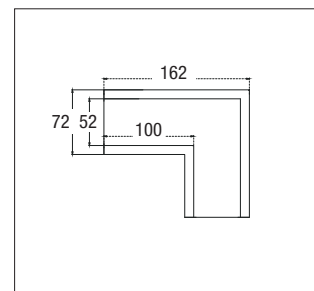
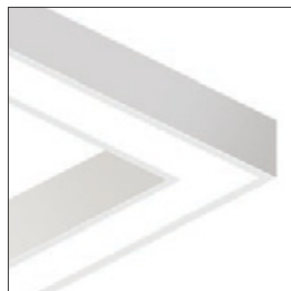

**Cod. 7270S-T**

**Kit congiunzione a T non luminoso**  
**T-shaped connection kit not bright**

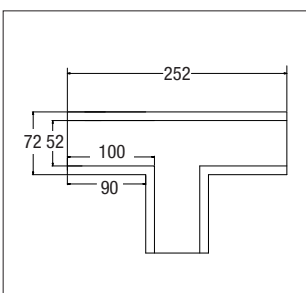

**Cod. 7270S-X**

**Kit congiunzione a X non luminoso**  
**X-shaped connection kit not bright**

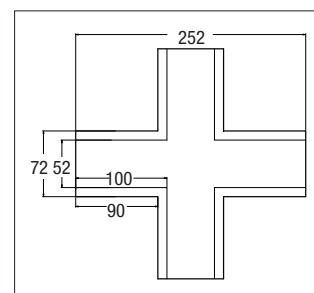
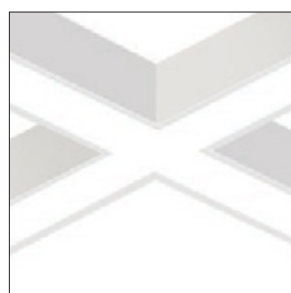

**Cod. LS7270S002**

**Testate terminali (2pcs)**

**End caps (2pcs)**

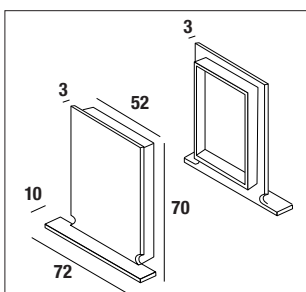

Collegabile in serie, a scomparsa semplice e stabile.  
Connectable in series, simple and stable retractable.

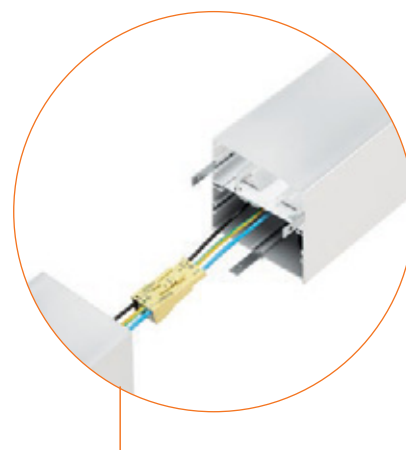

Connessione Fast di serie.  
Fast connection as per standard.

# LEDresswall R

installazione su doghe o cartongesso  
*on strip false ceilings or plasterboard installation*

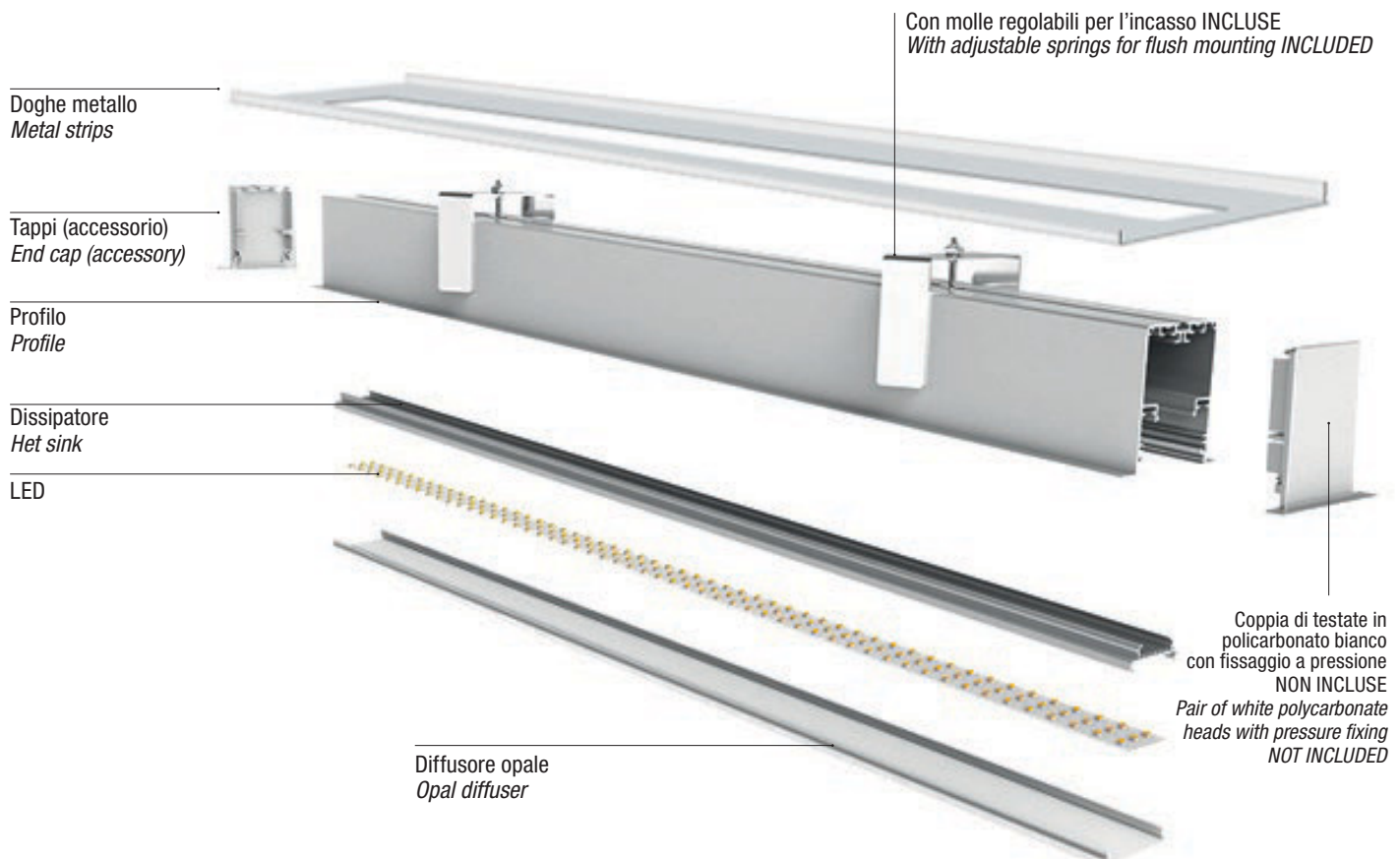
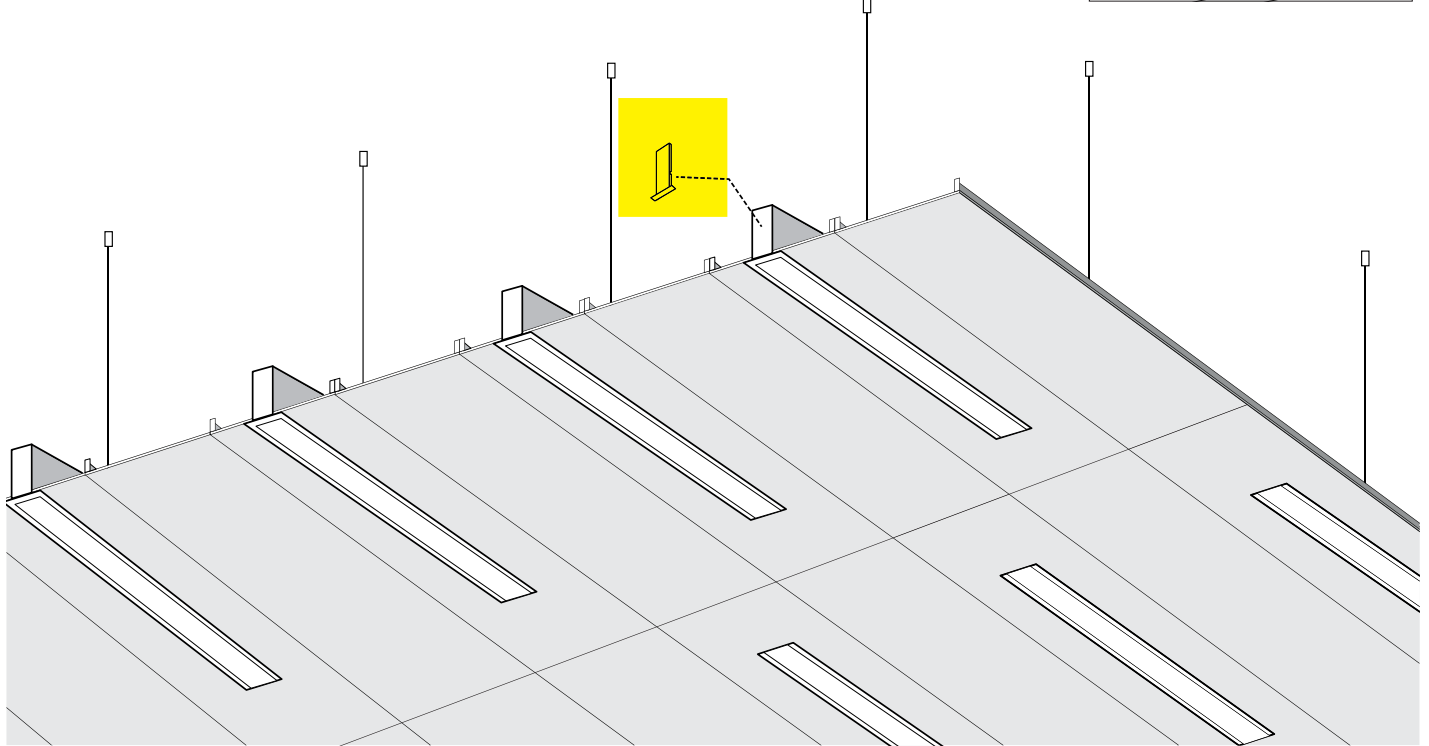
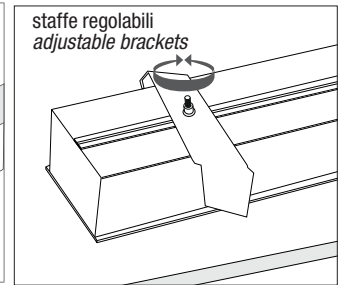
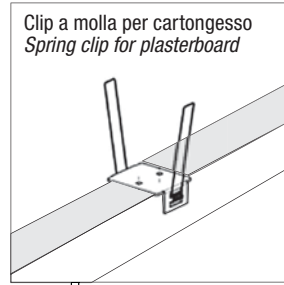

Recessed-ceiling-suspended

## Equal Family

A RICHIESTA  
ON DEMAND

WIRELESS

0-10V

DALI 2



Famiglia di apparecchi ad incasso, plafone, parete e sospensione ad elevato comfort visivo. Ideale per spazi dove è necessario un basso livello di abbagliamento. Il bassissimo consumo energetico e le contenute temperature garantiscono una lunga durata al prodotto.

L'utilizzo della tecnologia LED garantisce una resa luminosa elevata in relazione al consumo di energia, annullando i costi di manutenzione.

**Installazione:** ad incasso su cartongesso, plafone, parete e a sospensione.

**Corpo e telaio:** corpo realizzato in alluminio anodizzato pressofuso verniciato nelle finiture bianco RAL9010 o in nero RAL9005, Equal Road con cornice grigia.

**Staffe di fissaggio:** in acciaio

**Verniciatura:** di tipo poliestere eseguita a polvere.

**Ottica:** in materiale termoplastico, ad alta definizione integrata nello schermo antiabbagliamento nero o bianco che definisce un'emissione con luminanza controllata.

Ottiche: wide flood.

Il particolare sistema ottico permette una distribuzione luminosa definita, evitando l'effetto puntiforme.

**Temperatura di colore:** 3000K Equal Road, 3000K e 4000K serie Equal (6000K a richiesta).

**Driver multipotenza:** incluso. Fattore di potenza  $\geq 0,95$

**Conforme alla norma:** EN60598-1, RG0 nessun rischio fotobiologico ai fini della norma EN62471.

**Led:** Mantenimento del flusso luminoso minimo al 80%: 50.000h (L80B10).

*Family of recessed, surface-mounted, wall and pendant luminaires with high visual comfort. Ideal for spaces where a low level of glare is required.*

*Very low energy consumption and low temperatures guarantee a long product life.*

*LED technology guarantees high light output in relation to energy consumption, eliminating completely maintenance costs.*

**Installation:** flush mounted with no tools required or ceiling-mounted with the accessory to be ordered separately.

**Body and frame:** body made of die-cast anodized aluminum painted in white RAL9010 or black RAL9005, Equal Road with gray frame.

**Fastening brackets:** in steel

**Painting:** powder polyester coating.

**Optics:** made of high-definition thermoplastic material integrated into the black or white anti-glare screen that defines controlled luminance emission. Wide flood optics.

The particular optical system allows for defined and circular light distribution, avoiding the punctiform effect.

**Colour temperature:** 3000K Equal Road, 3000K and 4000K Equal series (6000K on request).

**Multipower driver:** included. Power factor  $\geq 0,95$

**According to standard:** EN60598-1, RG0 exempt from photo-biological risks in compliance with standard EN62471.

**Led:** Maintenance of minimum luminous flux to 80%: 50.000h (L80B10).

# panoramica prodotti - *products overview*

**Equal Road** incasso/recessed

---

LED Equal Road 20



**Equal** incasso/recessed

---

LED Equal 4 R



**Equal** parete plafone/wall ceiling

---

LED Equal 4 CW double



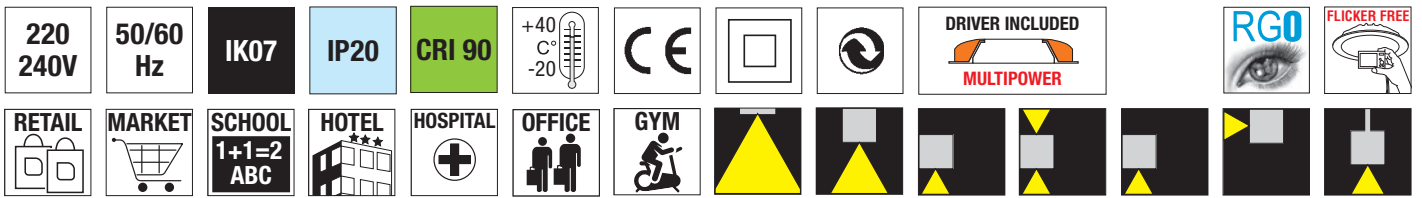

### LED Road Equal R



220-240V 50/60Hz **IK07** **IP20**

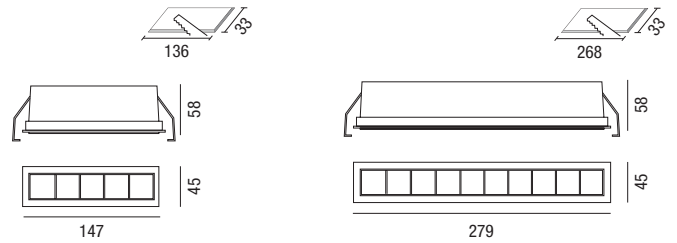

### LED Equal Road 10

colour	W		lm output	K	pcs	Kg	CELL
<b>G N</b>	9	30°	800	3000	001	0,23	28200
<b>DALI 2 G N</b>	9	30°	800	3000	001	0,23	28200/DA



### LED Equal Road 20

colour	W		lm output	K	pcs	Kg	CELL
<b>G N</b>	18	30°	1450	3000	001	0,45	28204
<b>DALI 2 G N</b>	18	30°	1450	3000	001	0,45	28204/DA

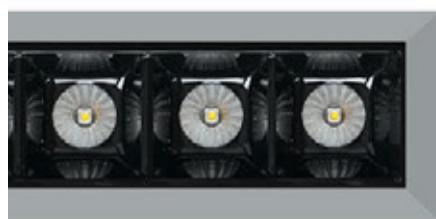

45mm.



30°

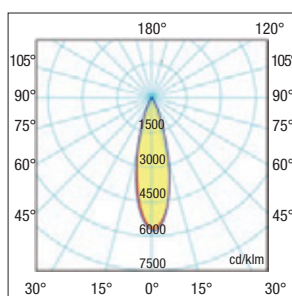

Recessed/ceiling



## LED Equal 4 R

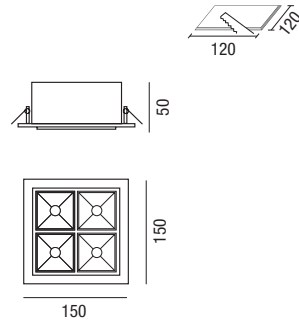

50°

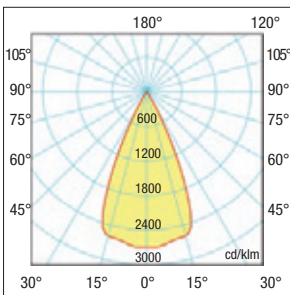

	colour	W		lm output	K	pcs	Kg	CELL
	B	15	50°	1500	3000	001	0,50	29200W
	N	15	50°	1500	3000	001	0,50	29200B
	B	15	50°	1500	3000	001	0,50	29200WDA
	N	15	50°	1500	3000	001	0,50	29200BDA
	B	15	50°	1500	4000	001	0,50	29200W/4K
	N	15	50°	1500	4000	001	0,50	29200B/4K
	B	15	50°	1500	4000	001	0,50	29200WDA/4K
	N	15	50°	1500	4000	001	0,50	29200BDA/4K

## LED Equal 4 CW double

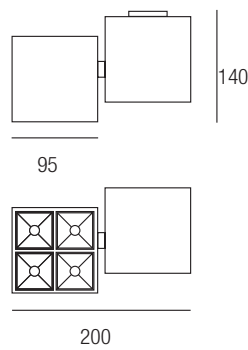

50°

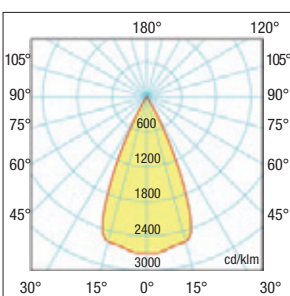

	colour	W		lm output	K	pcs	Kg	CELL
	B	15	50°	1500	3000	001	0,70	33200W
	N	15	50°	1500	3000	001	0,70	33200B
	B	15	50°	1500	3000	001	0,70	33200WDA
	N	15	50°	1500	3000	001	0,70	33200BDA
	B	15	50°	1500	4000	001	0,70	33200W/4K
	N	15	50°	1500	4000	001	0,70	33200B/4K
	B	15	50°	1500	4000	001	0,70	33200WDA/4K
	N	15	50°	1500	4000	001	0,70	33200BDA/4K





Recessed/ceiling

# LED Camilla C



Apparecchi da soffitto a base cilindrica, ideali per spazi commerciali (grandi magazzini, retail) alberghi e dove è necessaria una illuminazione d'accento.

Driver incorporato e sorgenti luminose comprese.

**Installazione:** a soffitto

**Corpo:** alluminio pressofuso. Verniciatura di tipo poliestere eseguita a polvere.

**Conforme alla norma:** EN60598-1, RG0 nessun rischio fotobiologico ai fini della norma EN62471.

**LED:** mantenimento del flusso luminoso minimo al 80%: 50.000h (L80B10).

*Ceiling luminaires with a cylindrical base, ideal for commercial spaces (department stores, retail), hotels and where accent lighting is required.*

*Built-in driver and light sources included.*

**Installation:** ceiling

**Body:** die-cast aluminum. Powder coated polyester type.

**Compliant with standard:** EN60598-1, RG0 no photobiological risk for the purposes of standard EN62471.

**LED:** minimum luminous flux maintenance at 80%: 50,000h (L80B10).



**Only with  
GU10 7W**

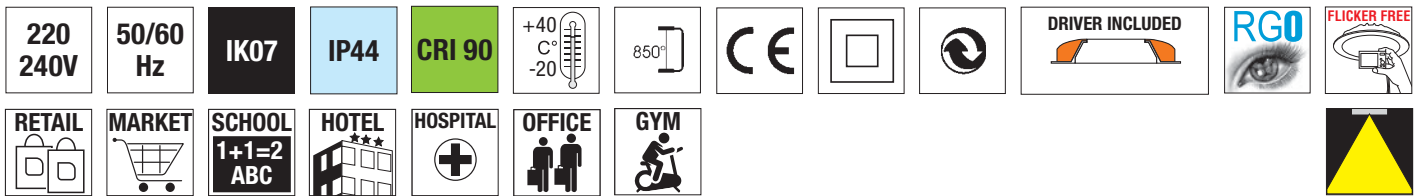

## LED Camilla C

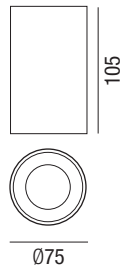

Color	W max		Lm Output		K	pcs	Kg	CELL
B	7	Led GU10	700	36°	3000	001	0,300	CAM49W7W3K
B	7	Led GU10	700	36°	4000	001	0,300	CAM49W7W4K
N	7	Led GU10	700	36°	3000	001	0,300	CAM49B7W3K
N	7	Led GU10	700	36°	4000	001	0,300	CAM49B7W4K



## Dati fotometrici - Photometric data

36°

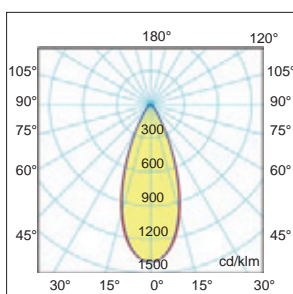

## LED Dolcetondo C



Recessed

Apparecchi da soffitto a base cilindrica, ideali per spazi commerciali (grandi magazzini, retail) alberghi e dove è necessaria una illuminazione d'accento.

Driver incorporato e sorgenti luminose comprese.

**Installazione:** a soffitto

**Corpo:** alluminio pressofuso. Verniciatura di tipo poliestere eseguita a polvere.

**Conforme alla norma:** EN60598-1, RG0 nessun rischio fotobiologico ai fini della norma EN62471.

**LED:** mantenimento del flusso luminoso minimo al 80%: 50.000h (L80B10).

*Ceiling luminaires with a cylindrical base, ideal for commercial spaces (department stores, retail), hotels and where accent lighting is required.*

*Built-in driver and light sources included.*

**Installation:** ceiling

**Body:** die-cast aluminum. Powder coated polyester type.

**Compliant with standard:** EN60598-1, RG0 no photobiological risk for the purposes of standard EN62471.

**LED:** minimum luminous flux maintenance at 80%: 50,000h (L80B10).

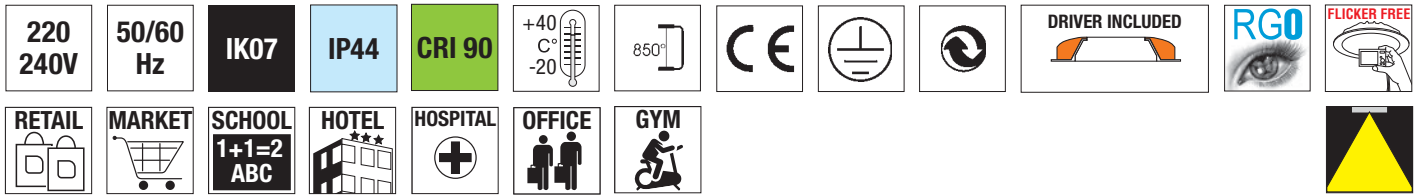

## LED Dolcetondo C

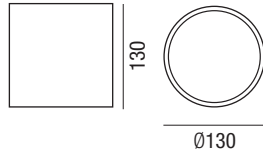

Color	W max	Beam angle	K	pcs	Kg	CELL
B	20 - 25 - 30	40°	3000	001	0,400	DOLCE3K28
B	20 - 25 - 30	40°	4000	001	0,400	DOLCE4K28
N	20 - 25 - 30	40°	3000	001	0,400	DOLCE3K28B
N	20 - 25 - 30	40°	4000	001	0,400	DOLCE4K28B
DALI 2 PUSH B	20 - 25 - 30	40°	3000	001	0,400	DOLCE3K28DA
DALI 2 PUSH B	20 - 25 - 30	40°	4000	001	0,400	DOLCE4K28DA
DALI 2 PUSH N	20 - 25 - 30	40°	3000	001	0,400	DOLCE3K28BDA
DALI 2 PUSH N	20 - 25 - 30	40°	4000	001	0,400	DOLCE4K28BDA

### Dati fotometrici - Photometric data

40°

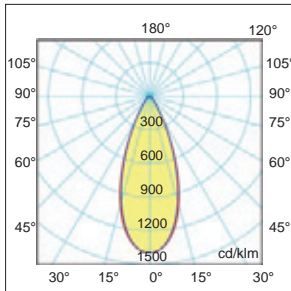

### Tabella di scelta potenza driver LED - LED Power supply table choice



Fornito di dip switch per la selezione della corrente in uscita. Il driver incluso nel prodotto ha una taratura di fabbrica (vedere tabella). Se necessario è possibile diminuire la potenza.

**Equipped with dip switch for selecting the current output. The driver included inside the product have a driver standard factory setting (see table). If necessary, it is possible to decrease the power.**

Taratura Dip-switch	Potenza Power	Lm Output
mA	Watt	Lm
800	21	2300
950	25	2650
1050	28	3000

Taratura standard di fabbrica  
Driver Standard factory setting

# Professional Panel Light

## LED Quadro trifase

A RICHIESTA  
ON DEMAND



vedi pag.  
see pag.

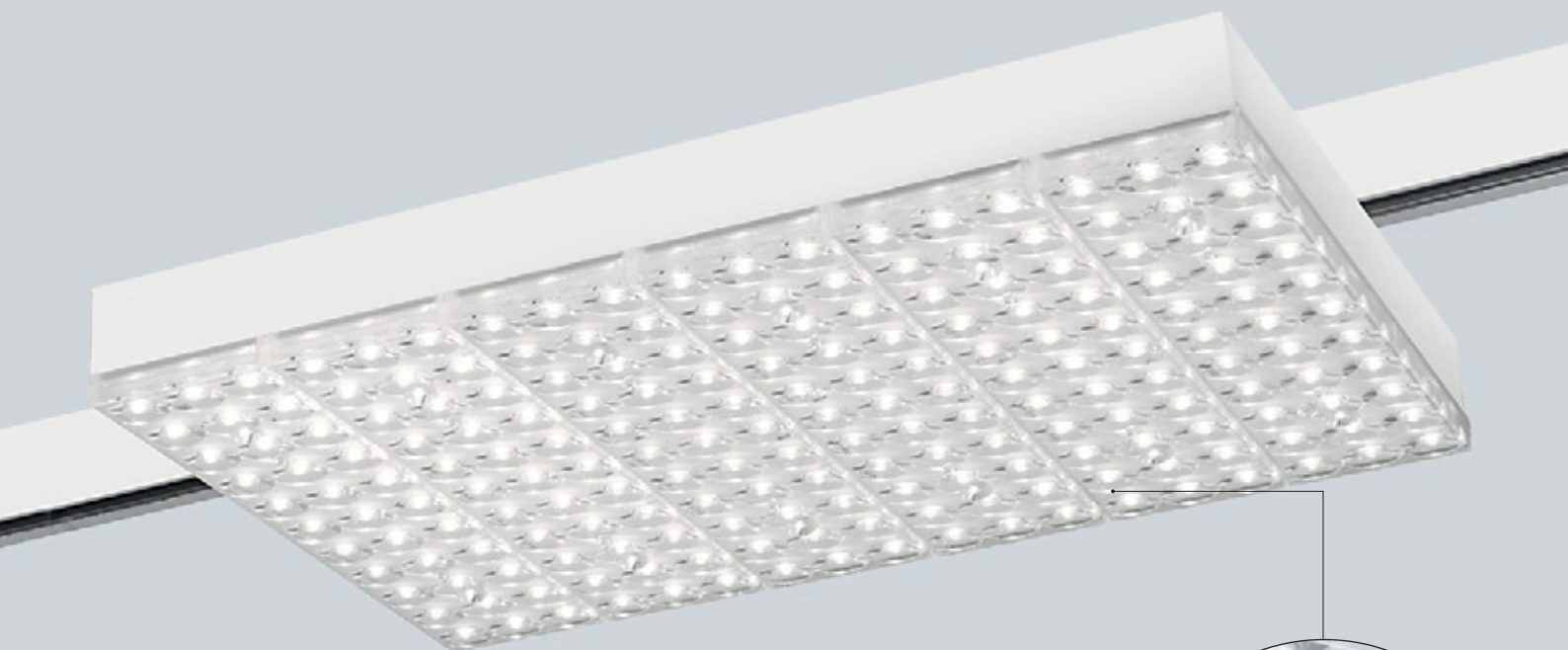

### A richiesta:

- Potenze diverse
- Temperatura di colore 3000K - 5.000K
- Colore corpo custom
- Lenti con gradazioni differenti

### On request:

- Different powers
- Color temperature 3000K - 5.000K
- Custom body color
- Lenses with different shades

Apparecchi a LED compatti e potenti, di forma contenuta con spessore di soli 24mm. sono adatti ad illuminare centri commerciali, ambienti industriali e aree espositive in genere; con corpo pressofuso in alluminio di alta qualità. Adatti per musei, negozi, esposizioni, nessuna emissione di raggi UV o infrarossi (col tempo non scoloriscono né scaldano gli oggetti).

**Corpo:** in acciaio verniciato di colore bianco RAL9010 o nero RAL9005.

**Lenti:** lenti a distribuzione ampia in metacrilato trasparente con superficie esterna chiara.

**Schermo:** tecnopolimero trasparente.

**Temperatura di colore:** 4000K.

**Conforme alla norma:** EN60598-1, RG0 nessun rischio fotobiologico ai fini della norma EN62471.

**Led:** CREE mantenimento del flusso luminoso minimo al 80%: 50.000h (L80B10).

**Driver:** incluso  Fattore di potenza  $\geq 0,95$ .

**Prodotto conforme alle direttive:** 

*Triple anti-glare led track spot light with High quality aluminum diecast light body, Cold forging process on high purity metal. Perfect for art gallery and fashion shop lighting.*

*Suitable for museums, shops and displays, no UV ray or infra-red emissions (they do not cause objects to fade or heat up over time).*

**Body:** in steel painted in white RAL9010 or black RAL9005.

**Lens:** Wide distribution lenses in clear methacrylate with clear outer surface.

**Screen:** transparent polymer sheet.

**Colour temperature:** 4000K.

**Compliant with standard:** EN60598-1, RG0 no photobiological risk for the purposes mentioned in standard EN62471.

**LED:** CREE  maintenance of 80% minimum luminous flux: 50,000h (L80B10).

**Driver:** included   $\geq 0.95$  Power factor.

**Product compliant with directives:** 



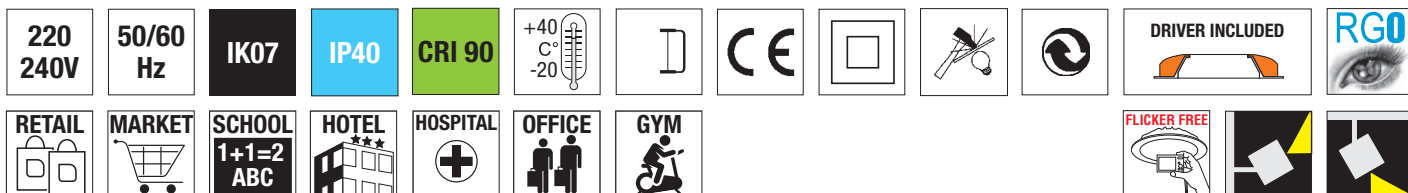

### LED Quadro trifase 37W

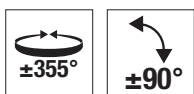
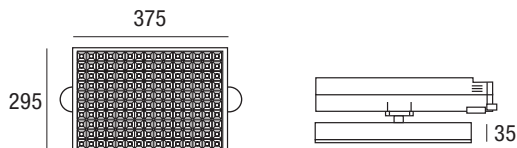

	colour	W max	lm output max *	K		pcs	Kg	CELL
	B	37	4200	4000	90°	001	3	33555-90
	N	37	4200	4000	90°	001	3	33556-90
	B	37	4200	4000	30°	001	3	33555-30
	N	37	4200	4000	30°	001	3	33556-30
	<b>DALI 2</b> B	37	4200	4000	90°	001	3	33555-90-DA
	<b>DALI 2</b> N	37	4200	4000	90°	001	3	33556-90-DA
	<b>DALI 2</b> B	37	4200	4000	30°	001	3	33555-30-DA
	<b>DALI 2</b> N	37	4200	4000	30°	001	3	33556-30-DA

3000K

5000K

A richiesta, minimo 50 pcs, aggiungere 3K o 5K dopo il codice.  
On request, at least 50 pcs, add 3K or 5K after the code.

### LED Quadro trifase 30W

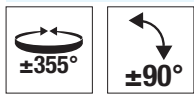
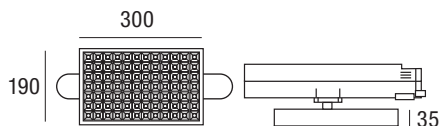

	colour	W max	lm output max *	K		pcs	Kg	CELL
	B	30	3100	4000	90°	001	2,5	33557-90
	N	30	3100	4000	90°	001	2,5	33558-90
	B	30	3100	4000	30°	001	2,5	33557-30
	N	30	3100	4000	30°	001	2,5	33558-30
	<b>DALI 2</b> B	30	3100	4000	90°	001	2,5	33557-90-DA
	<b>DALI 2</b> N	30	3100	4000	90°	001	2,5	33558-90-DA
	<b>DALI 2</b> B	30	3100	4000	30°	001	2,5	33557-30-DA
	<b>DALI 2</b> N	30	3100	4000	30°	001	2,5	33558-30-DA

3000K

A richiesta, minimo 50 pcs, aggiungere 3K dopo il codice.  
On request, at least 50 pcs, add 3K after the code.

#### 30°- Semi-concentrante - Spot

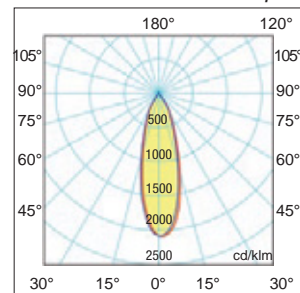

#### 90° - Diffondente - Wide

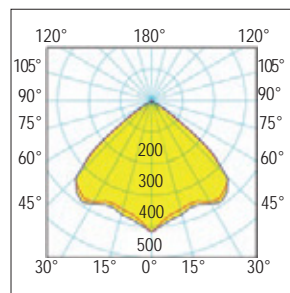



Ottica bi-asimmetrica  
bi-asymmetric optics

LED Quadro trifase 37W Bi-Asimetrica

**NEW** A richiesta - *On request*

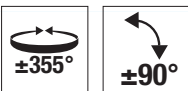
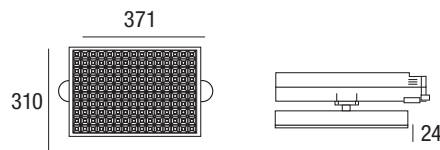
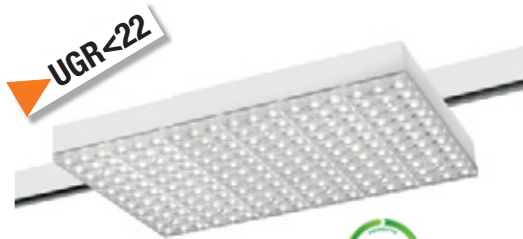

Ottica bi-asimmetrica  
Bi-asymmetric optics

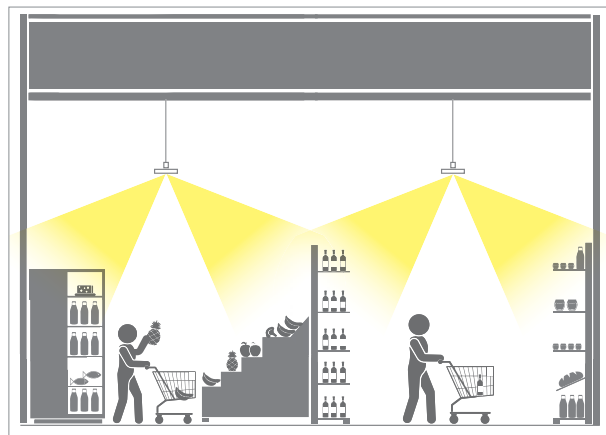
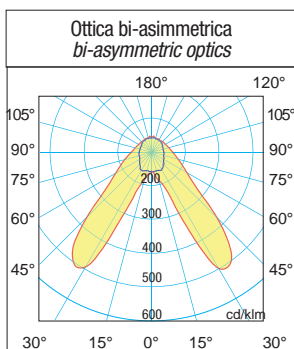

Adatta per gli spazi commerciali  
al fine di dare maggior risalto alla  
merce esposta rispetto alle corsie.

*Suitable for commercial spaces  
to allow the displayed goods to  
stand out respect to the lanes.*



Fornito di dip switch per la selezione della corrente in uscita - *Equipped with dip switch for selecting the current output.*



CE EMC 300MHz SELV RoHS compliance EL PFC DIP-SWITCH Multipower RIPPLE FREE

lout	mA	500	600	700	800	900	1000	1050
Power *	W	18	21	25	28	32	35	37
Lm output max **	Lm	1980	2300	2750	3080	3520	3850	4200

\* La taratura del Driver non deve in nessun caso superare la potenza (Wmax) della lampada.  
The Driver setting must in no case exceed the power (Wmax) of the lamp.

Taratura standard di fabbrica  
Driver Standard factory setting

### Orientabilità - Adjustability



**LED Primadonna - LED Regina 3CCT**A RICHIESTA  
ON DEMAND

Serie di proiettori orientabili progettati per illuminare spazi commerciali (supermercati, grandi magazzini, retail, ecc.), uffici e qualsiasi ambiente dove è necessaria un'illuminazione generale e d'accento.

L'utilizzo della tecnologia LED garantisce una resa illuminotecnica elevata in relazione al consumo di energia, annullando i costi di manutenzione con un notevole risparmio economico.

**Installazione:** su binario trifase Eurostandard (completo di adattatore)

**Corpo:** in alluminio pressofuso UNI 5076, verniciato con polvere termoindurente poliestere. Colore Nero opaco RAL 9005 o Bianco opaco RAL 9010.

**Orientabilità:** Z=350°, Y=90°

**Viteria:** in acciaio

**Verniciatura:** di tipo poliestere eseguita a polvere

**Ottica:** concentrante e semi concentrante

**Schermo:** vetro temperato di spessore 3mm

**Temperatura di colore:** 3000K e 4000K; altre temperature di colore a richiesta

**Conforme alla norma:** EN60598-1, RG0 nessun rischio fotobiologico ai fini della norma EN62471.

**Led:** CREE manutenzione del flusso luminoso minimo al 80%: 50.000h (L80B10)

**Driver:** incluso Fattore di potenza ≥0,95.

*A series of direction-adjustable flood lights designed for lighting in shopping malls (supermarkets, department stores, retail stores, etc.), offices and any facility requiring general and accent lighting. The use of LED technology guarantees high lighting engineering output in relation to energy consumption, eliminating maintenance costs and thereby offering considerable economic savings.*

**Installation:** on three-phase Eurostandard tracks (complete with adapter)

**Body:** made by UNI 5076 die-cast aluminum, coated with polyester thermoset powder.

**Adjustability:** Z=350°, Y=90°.

**Screws:** made by steel.

**Coating:** coated with powdered polyester. RAL Black 9005 or RAL 9010 White color.

**Optic:** semi-clumping.

**Optic:** clumping and semi-clumping.

**Shield:** tempered glass with 3mm thickness.

**Color temperature:** 3000K and 4000K; other color temperatures available on demand.

**According to standard:** EN60598-1, RG0 exempt from photobiological risks in compliance with standard EN62471.

**Led:** CREE maintenance of minimum luminous flux to 80%: 50.000h (L80B10)

**Driver:** included Power factor ≥0,95.

**Orientabilità - Adjustability**

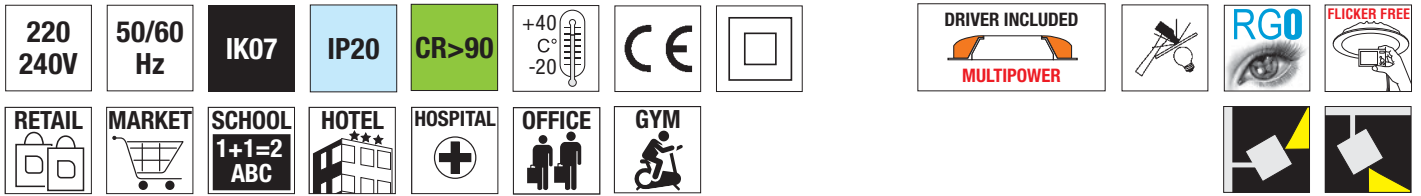

### LED Primadonna U-Boot 20-30W



	colour	W max	K		pcs	Kg	CELL
<b>U-BOOT</b>	B	30	3000	40°	001	1,30	3292030UB
<b>U-BOOT</b>	B	30	3000	40°	001	1,30	32920UBDA
<b>U-BOOT</b>	B	30	4000	40°	001	1,30	32920304KUB
<b>U-BOOT</b>	B	30	4000	40°	001	1,30	329204KUBDA
<b>U-BOOT</b>	B	30	3000	24°	001	1,30	32921/30/UB
<b>U-BOOT</b>	B	30	3000	24°	001	1,30	32921/UBDA
<b>U-BOOT</b>	N	30	3000	40°	001	1,30	32922/30/UB
<b>U-BOOT</b>	N	30	3000	40°	001	1,30	32922/UBDA
<b>U-BOOT</b>	N	30	4000	40°	001	1,30	32922304KUB
<b>U-BOOT</b>	N	30	4000	40°	001	1,30	329224KUBDA

24°

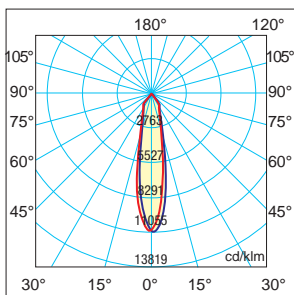

40°

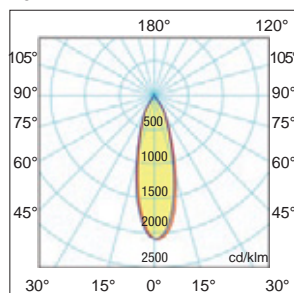

#### Taratura/Settings DIP-SWITCH

<b>lout</b>	<b>mA</b>	300	400	450	550	650	700
<b>Lm</b>	<b>Lm output</b>	1.690	2.210	2.470	2.990	3.510	3.770
<b>Power</b>	<b>W</b>	13	17	19	23	27	29
Taratura standard di fabbrica Driver standard factory settings							

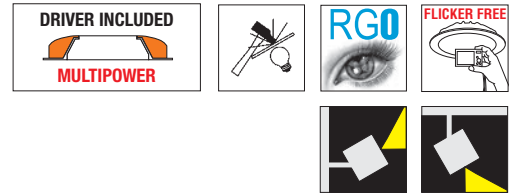
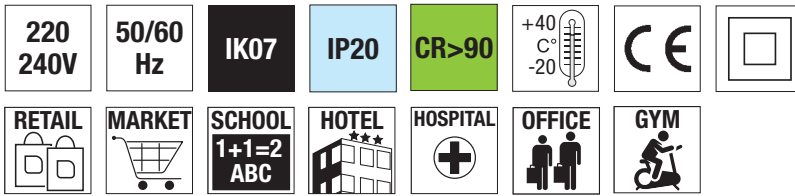

### LED Primadonna 60W



### LED Primadonna 60W

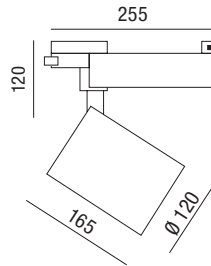

colour	W	lm output	K		pcs	Kg	CELL
B	60	7800	3000	40°	001	1,55	32920/60
B	60	7800	4000	40°	001	1,55	32920/60/4K
B	60	7800	3000	24°	001	1,55	32921/60
B	60	7800	4000	24°	001	1,55	32921/60/4K
N	60	7800	3000	40°	001	1,55	32922/60
N	60	7800	4000	40°	001	1,55	32922/60/4K
N	60	7800	3000	24°	001	1,55	32923/60
N	60	7800	4000	40°	001	1,55	32923/60/4K

24°

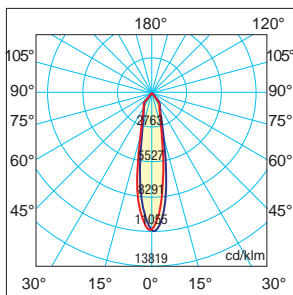

40°

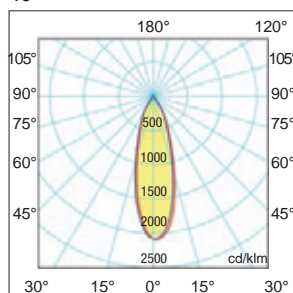

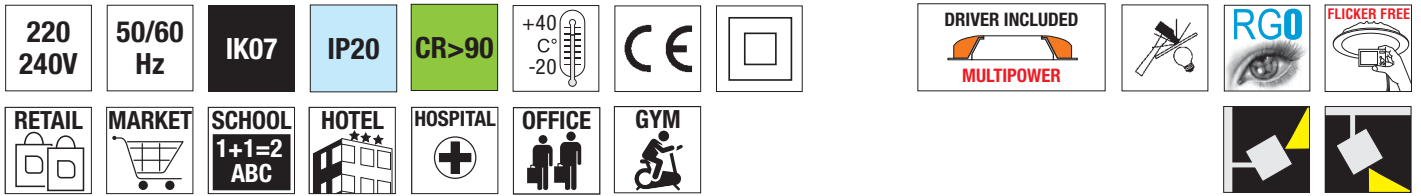

**LED Regina 3 CCT**

**NEW**

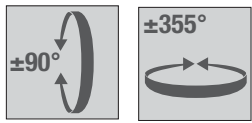
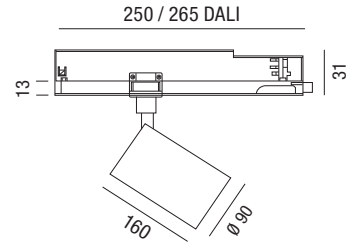

	colour	W max	K			△	pcs	Kg	CELL
<b>U-BOOT</b>	B	30	3000	3500	4000	15°	001	1,30	REG3CCT3015
<b>U-BOOT</b>	B <b>DALI 2</b>	30	3000	3500	4000	15°	001	1,30	REG3CCT3015DA
<b>U-BOOT</b>	B	30	3000	3500	4000	25°	001	1,30	REG3CCT3025
<b>U-BOOT</b>	B <b>DALI 2</b>	30	3000	3500	4000	25°	001	1,30	REG3CCT3025DA
<b>U-BOOT</b>	B	30	3000	3500	4000	40°	001	1,30	REG3CCT3040
<b>U-BOOT</b>	B <b>DALI 2</b>	30	3000	3500	4000	40°	001	1,30	REG3CCT3040DA
<b>U-BOOT</b>	N	30	3000	3500	4000	15°	001	1,30	REG3CCT3015B
<b>U-BOOT</b>	N <b>DALI 2</b>	30	3000	3500	4000	15°	001	1,30	REG3CCT3015BDA
<b>U-BOOT</b>	N	30	3000	3500	4000	25°	001	1,30	REG3CCT3025B
<b>U-BOOT</b>	N <b>DALI 2</b>	30	3000	3500	4000	25°	001	1,30	REG3CCT3025BDA
<b>U-BOOT</b>	N	30	3000	3500	4000	40°	001	1,30	REG3CCT3040B
<b>U-BOOT</b>	N <b>DALI 2</b>	30	3000	3500	4000	40°	001	1,30	REG3CCT3040BDA

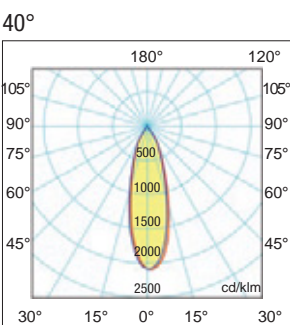
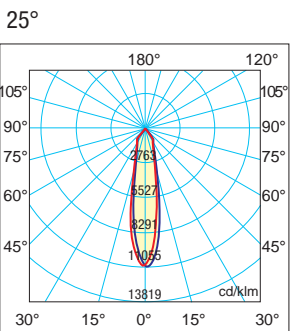
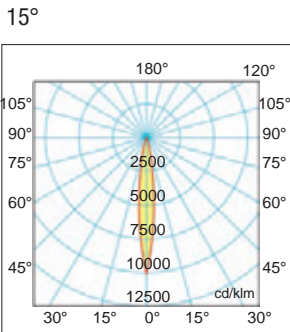

**Accessori non inclusi - Not included accessories**

**Filtri - Filters**

Colour	Code	Code
N	Frangiluce nido d'ape. Honeycomb louvre.	REG3CCT/FRA

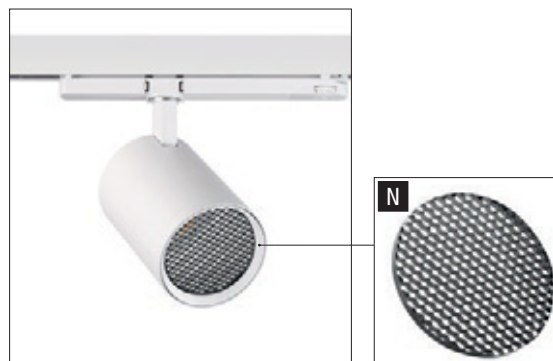

**Taratura DIP SWITCH - DIP SWITCH setting**



Taratura/Settings DIP-SWITCH					
lout	mA	450	550	650	700
Lm	Lm output	2.470	2.990	3.510	3.770
Power	W	19	23	27	30
Taratura standard di fabbrica Driver standard factory settings					





# LED Primadonna Sistemi di controllo

## Control systems

RIPPLE FREE

WIRELESS

CASAMBI

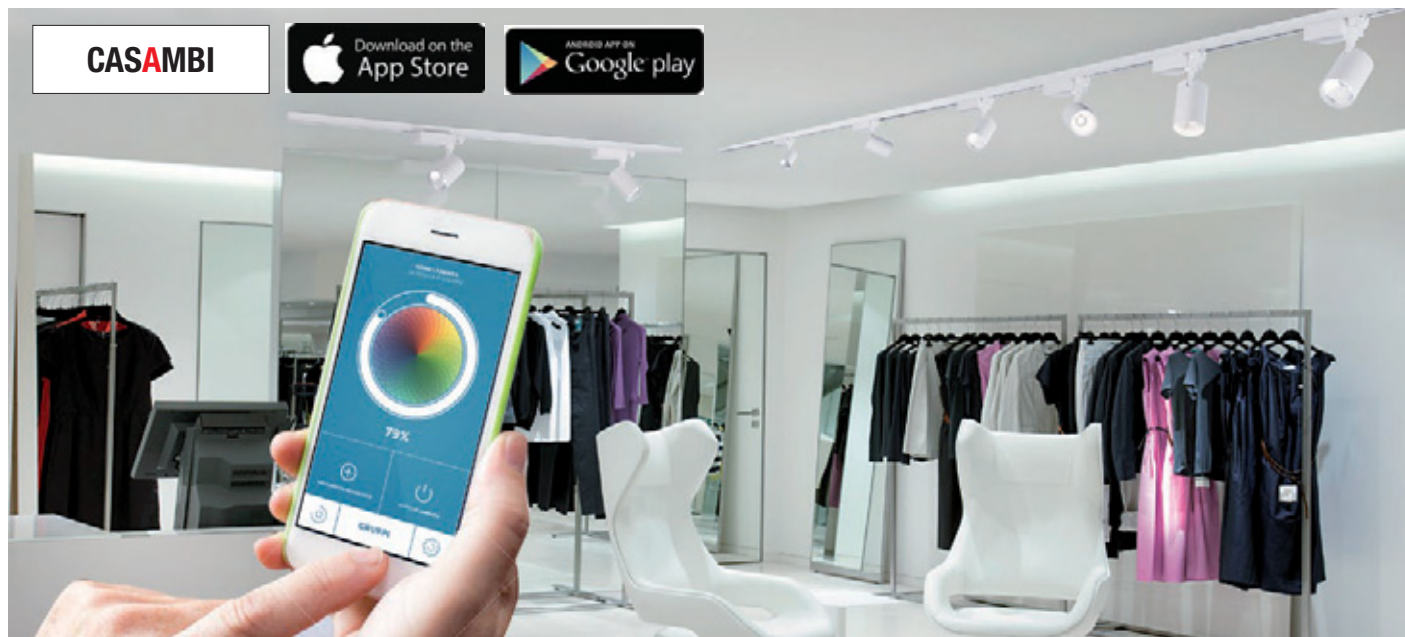
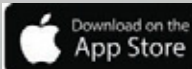

**Adattatore da binario con LED driver WIRELESS incorporato, max 30W**  
**Track adapter with built-in WIRELESS LED driver, 30W max.**

WIRELESS ANTENNA  
 KEEP CLEAR THIS AREA

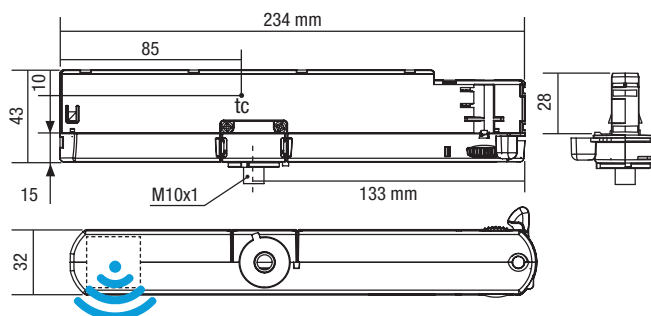

Articolo Article	Codice Code	Colore Color
31/325-700	R-127664	Bianco RAL 9010 White RAL 9010
31/325-700	R-127666	Nero RAL 9005 Black RAL 9005

**Tensione Nominale**  
**Rated Voltage**  
 220 ÷ 240 V

**Corrente Nominale**  
**Rated Current**  
 0,20 A

**Corrente di Spunto**  
**Inrush Current**  
 5 A - 50 µs

**Potenza Uscita**  
**Output Power**  
 6,5 ÷ 31 W

**Standards compliance**

EN 55015  
 EN 61000-3-2  
 EN 61347-1  
 EN 61347-2-11  
 EN 61547  
 EN 62311  
 ETSI EN 300 328  
 ETSI EN 301 489-1 - ETSI EN 301 489-17

### Caratteristiche

- Dispositivo multipotenza fornito di dip-switch per la selezione della corrente in uscita con **integrato modulo wireless CASAMBI**.
- Design all'avanguardia.
- Il design della lampada prima di tutto.
- Elevata potenza disponibile in uno spazio molto ridotto.
- Facile da montare con innovativi attacchi.
- Disponibile in bianco, nero e grigio.
- PFC attivo.
- Protetto in classe II contro le scosse elettriche per contatti diretti e indiretti.
- Corrente regolata  $\pm 5/6$  % incluse variazioni di temperatura.
- Morsetti di uscita ad innesto rapido: 0,2...0,5 mm2
- Protezioni:
  - termica e cortocircuito;
  - contro le extra-tensioni di rete;
  - contro i sovraccarichi.
- Protezione termica = C.5.a

### Features

- Multipower device supplied with dip-switch for the selection of the output current **with integrated wireless CASAMBI module**.
- A new breakthrough in luminaire design.
- Puts the luminaire design first.
- High power available in a very reduced space.
- Easy to mount through inventive nipple design.
- Available in white, black & grey
- Active Power Factor Corrector.
- Class II protection against electric shock for direct or indirect contact.
- Current regulation  $\pm 5/6$  % including temperature variations.
- Output push-in terminal blocks: 0,2...0,5 mm2
- Protections:
  - against overheating and short circuits;
  - against mains voltage spikes;
  - against overloads.
- Thermal protection = C.5.a

### CASAMBI ACCESSORI - ACCESSORIES

Articolo - Article	Codice - Code	Colore - Color
XPRESS-W-C-239	181226	Bianco/White RAL 9010
XPRESS-B-C-239	181227	Nero/ Black RAL 9005



### CASAMBI XPRESS-W-C-239 CASAMBI XPRESS-B-C-239

- Interfaccia utente wireless
- Tensione nominale: batteria (CR2430)
- 4 pulsanti
- Controllo singola lampada o gruppi
- Recall di scene e animazioni
- Variazione temperatura colore
- Variazione livello di illuminazione diretta/indiretta
- Raggio di copertura: fino a 50 m (campo libero)
- IP 20

### CASAMBI XPRESS-W-C-239 CASAMBI XPRESS-B-C-239

- Wireless user interface
- Rated Voltage: battery (CR2430)
- Four target buttons
- Single luminaire & groups control
- Scenes & animations recall
- Colour temperature change
- Direct/Indirect lighting ratio change
- Transmission range (free field): up to 50 m
- IP20

LED Regina R 2CCT **NEW** 2023A RICHIESTA  
ON DEMAND

WIRELESS

DALI 2



Apparecchi ad incasso progettati per illuminare sale riunioni, uffici, negozi, cucine e qualsiasi ambiente dove è necessaria un'illuminazione potente e direzionabile.

**Installazione:** ad incasso per controsoffitti in cartongesso (completo di staffe di fissaggio).

**Corpo e telaio:** in alluminio pressofuso UNI 5076 verniciato con polvere termoindurente poliestere.

**Orientabilità:** il corpo è estraibile ed orientabile su due assi, rispettivamente di Z=360°, Y=68°.

**Staffe di fissaggio:** in alluminio.

**Verniciatura:** di tipo poliestere eseguita a polvere.  
Colore bianco RAL 9010, nero RAL 9005.

**Ottica:** 40° riflettore in policarbonato.

**Schermo:** lastra in tecnopolimero trasparente.

**Temperatura di colore:** 2CCT 3000K e 4000K.

**Driver multipotenza:**  non incluso. Fattore di potenza  $\geq 0,95$ .

**Conforme alla norma:** EN60598-1, RG0 nessun rischio fotobiologico ai fini della norma EN62471.

Prodotto conforme alle direttive: 

*Recessed downlights designed to light up common areas, meeting rooms, offices, shops, kitchens, and any other place that requires diffused lighting powerful and directional.*

**Installation:** recessed use in plasterboard false ceilings (complete with fixing brackets)

**Body and frame:** made by UNI 5076 die-cast aluminum, coated with polyester thermoset powder.

**Adjustability:** Pull-out light Head pivot through Y=68°, rotates through Z=360°.

**Fixing brackets:** made by aluminum material.

**Coating:** coated with powdered polyester.

RAL 9010 white color or RAL 9005 black color.

**Optic:** 40° polycarbonate Reflector.

**Shield:** transparent engineering polymer sheet.

**Color temperature:** 2CCT 3000K e 4000K.

**Driver multipower:**  not included. Power factor  $\geq 0,95$ .

**According to standard:** EN60598-1, RG0 exempt from photo-biological risks in compliance with standard EN62471.

**Product compliant with directives:** 



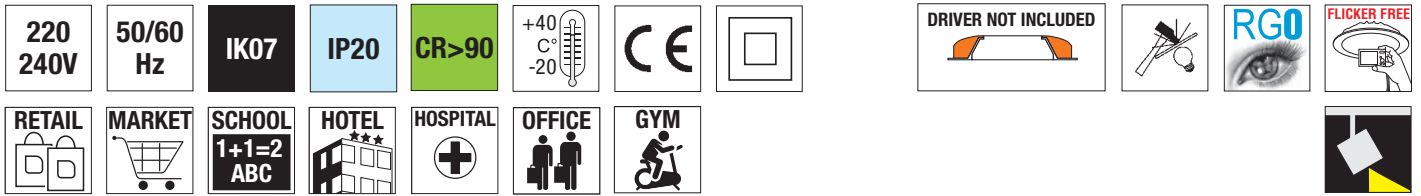

### LED Regina R 2CCT

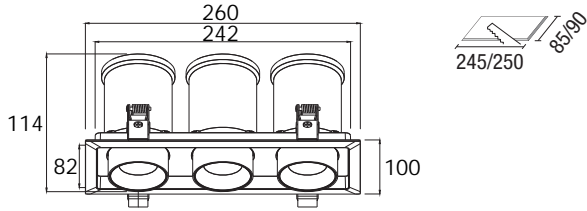

colour	W max	I max	lm output max	K	pcs/pallets	Kg	S+L
<b>N</b>	3x14	1050 mA	4200	3000	4000	6	1.5 329402CCT
<b>B</b>	3x14	1050 mA	4200	3000	4000	6	1.5 329412CCT

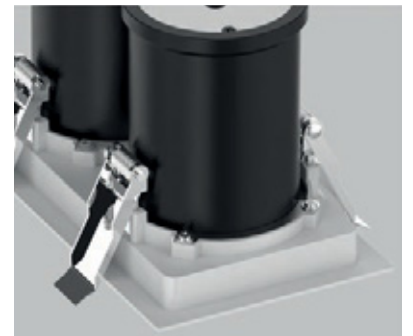
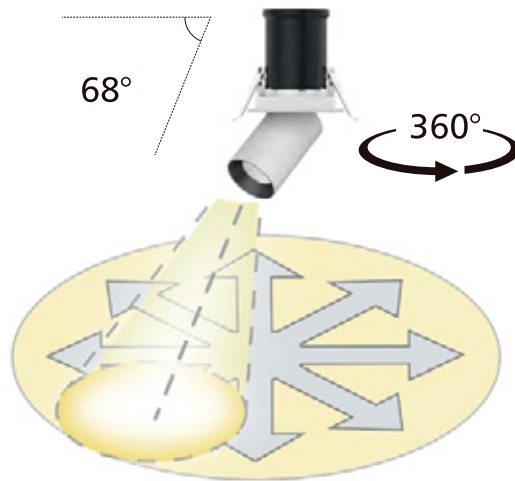
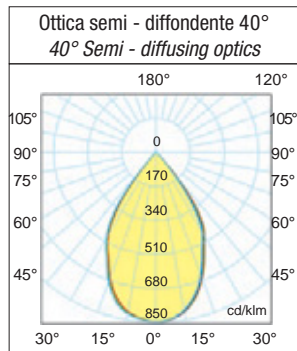

### Accessori non inclusi - Not included accessories



LED driver multipower   
**RN9164/FAST (ON-OFF)**  
**RN9164-1-10VF (0-10V)**  
**RN9168/DAFAST (DALI, PUSH, 0-10V)**  
**RN9182DAPUFAS (DALI2 PUSH)**



**Cod. 65151LED80CP3**  
 Kit emergenza 3W - 3h/12% 180÷250 Vac  
 180÷250 Vac - 3h/12% - 3W emergency kit

**Cod. RP0714CP3 - AUTOTEST**  
 Kit emergenza 3W - 3h/12% 180÷250 Vac  
 180÷250 Vac - 3h/12% - 3W emergency kit

### Tabella di scelta potenza driver LED - LED Power supply table choice

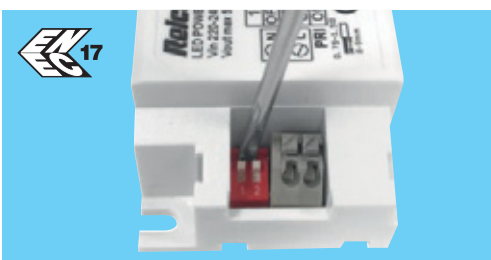

Fornito di dip switch per la selezione della corrente in uscita. Il driver incluso nella confezione è normalmente settato a 42W (vedi tabella). Se necessario è possibile diminuire la potenza e di conseguenza i lumen output.  
**Equipped with dip switch for selecting the current output.** The driver included inside the package is usually set to 42W (see table). If necessary it is possible to decrease the power and consequently the lumen output.

Taratura Dip-switch	Potenza Power	Lm Output
mA	Watt	Lm
700	28	2800
900	33	3300
1050	42	4200

Taratura standard di fabbrica  
 Driver Standard factory setting

# LED Primavera Trifase

A RICHIESTA  
ON DEMAND**WIRELESS**

Serie di proiettori orientabili progettati per illuminare spazi commerciali (supermercati, grandi magazzini, retail, ecc.), uffici e qualsiasi ambiente dove è necessaria un'illuminazione generale e d'accento.

L'utilizzo della tecnologia LED garantisce una resa illuminotecnica elevata in relazione al consumo di energia, annullando i costi di manutenzione con un notevole risparmio economico.

**Installazione:** su binario trifase Eurostandard (completo di adattatore).

**Corpo:** in alluminio pressofuso UNI 5076, verniciato con polvere termoindurente poliester.

**Colore:** Nero RAL 9005 o Bianco RAL 9003.

**Orientabilità:** Z=355°, Y=90°

**Viteria:** in acciaio.

**Verniciatura:** di tipo poliester eseguita a polvere.

**Ottica:** concentrante e semi concentrante.

**Schermo:** vetro temperato trasparente di spessore 3mm .

**Temperatura di colore:** 4000K.

**Conforme alla norma:** EN60598-1, RG0 nessun rischio fotobiologico ai fini della norma EN62471.

**Led:** CREE mantenimento del flusso luminoso minimo al 80%: 50.000h (L80B10).

**Driver:** incluso  Fattore di potenza ≥0,95.

*A series of direction-adjustable flood lights designed for lighting in shopping malls (supermarkets, department stores, retail stores, etc.), offices and any facility requiring general and accent lighting. The use of LED technology guarantees high lighting engineering output in relation to energy consumption, eliminating maintenance costs and thereby offering considerable economic savings.*

**Installation:** on three-phase Eurostandard tracks (complete with adapter)

**Body:** made by UNI 5076 die-cast aluminum, coated with polyester thermoset powder.

**Adjustability:** Z=355°, Y=90°

**Screws:** made by steel.

**Coating:** coated with powdered polyester. Black or RAL 9010 White color.

**Optic:** semi-clumping.

**Optic:** clumping and semi-clumping.

**Shield:** 3mm thick transparent tempered glass.

**Color temperature:** 4000K.

**According to standard:** EN60598-1, RG0 exempt from photobiological risks in compliance with standard EN62471.

**Led:** CREE maintenance of minimum luminous flux to 80%: 50.000h (L80B10).

**Driver:** included  Power factor ≥0,95.

## Orientabilità - Adjustability



±355°



±90°





**LED Primavera trifase 20-30W**

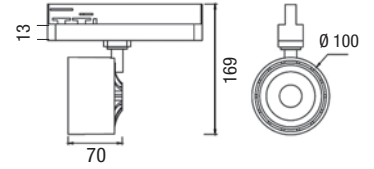

	colour	W	K	△	pcs	Kg	CELL
	B	30	3000	40°	002	1,30	PRV30403KW
	B	30	3000	40°	002	1,30	PRV30403KWDA
	N	30	3000	40°	002	1,30	PRV30403KB
	N	30	3000	40°	002	1,30	PRV30403KBDA
	B	30	4000	40°	002	1,30	PRV30404KW
	B	30	4000	40°	002	1,30	PRV30404KWDA
	N	30	4000	40°	002	1,30	PRV30404KB
	N	30	4000	40°	002	1,30	PRV30404KBDA

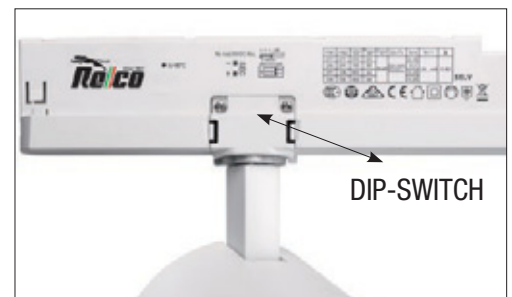
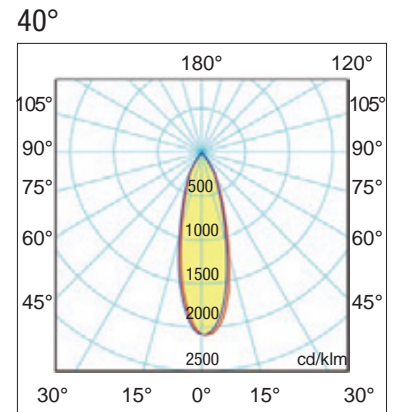

Taratura/Settings DIP-SWITCH

lout	mA	300	400	450	550	650	700
Lm	Lm output	1.690	2.210	2.470	2.990	3.510	3.770
Power	W	13	17	19	23	27	29

Taratura standard di fabbrica  
Driver standard factory settings

# LED Shop windows trifase - C-W

A RICHIESTA  
ON DEMAND

WIRELESS

0-10V

DALI 2

Proiettore orientabile progettato per illuminare spazi commerciali e uffici, grazie alla sua versatilità risulta particolarmente adatto per dare vita alle vetrine di negozi e qualsiasi ambiente dove è necessaria un'illuminazione generale e d'accento.

L'utilizzo della tecnologia LED garantisce una resa illuminotecnica elevata in relazione al consumo di energia, annullando i costi di manutenzione con un notevole risparmio economico.

**Installazione:** su binario trifase Eurostandard (completo di adattatore) o a parete plafone (versione C-W).

**Corpo:** in alluminio pressofuso UNI 5076, verniciato con polvere termoindurente poliestere. Colore Nero o Bianco RAL 9010.

**Orientabilità:** Z=350°, Y=90°

**Viteria:** in acciaio

**Verniciatura:** di tipo poliestere eseguita a polvere

**Ottica:** concentrante e semi concentrante

**Schermo:** vetro temperato di spessore 3mm

**Temperatura di colore:** 3000K e 4000K; altre temperature di colore a richiesta

**Conforme alla norma:** EN60598-1, RG0 nessun rischio fotobiologico ai fini della norma EN62471.

**Led:** CREE manutenzione del flusso luminoso minimo al 80%: 50.000h (L80B10).

**Driver:** incluso  Fattore di potenza ≥0,95.

*Direction-adjustable flood light designed for lighting in shopping and offices, thanks to its versatility it is particularly suitable for giving life to shop windows and any environment where general and accent lighting is required.*

*The use of LED technology guarantees high lighting engineering output in relation to energy consumption, eliminating maintenance costs and thereby offering considerable economic savings.*

**Installation:** on three-phase Eurostandard tracks (complete with adapter) or wall-ceiling (C-W version).

**Body:** made by UNI 5076 die-cast aluminum, coated with polyester thermoset powder.

**Adjustability:** Z=350°, Y=90°.

**Screws:** made by steel.

**Coating:** coated with powdered polyester. Black or RAL 9010 White color.

**Optic:** semi-clumping.

**Optic:** clumping and semi-clumping.

**Shield:** tempered glass with 3mm thickness.

**Color temperature:** 3000K and 4000K; other color temperatures available on demand.

**According to standard:** EN60598-1, RG0 exempt from photo-biological risks in compliance with standard EN62471.

**Led:** CREE maintenance of minimum luminous flux to 80%: 50.000h (L80B10).

**Driver:** included  Power factor ≥0,95.





### LED Shop windows 14W

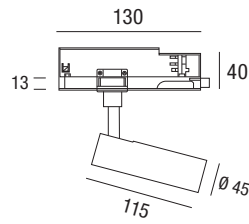

Piccolo ma potente, scompare nel binario e rimane molto discreto.

*Small but powerful, it disappears in the track and a lot remains discreet.*

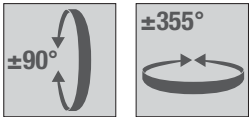

	colour	W max	K	△	pcs	Kg	CELL
	B	14	3000	40°	001	1,30	SCHW403KW
	B	14	3000	40°	001	1,30	SCHW403KWDA
	B	14	4000	40°	001	1,30	SCHW404KW
	B	14	4000	40°	001	1,30	SCHW404KWDA
	B	14	3000	24°	001	1,30	SCHW243KW
	B	14	4000	24°	001	1,30	SCHW244KW
	N	14	3000	40°	001	1,30	SCHW403KB
	N	14	3000	40°	001	1,30	SCHW403KBDA
	N	14	4000	40°	001	1,30	SCHW404KB
	N	14	4000	40°	001	1,30	SCHW404KBDA
	N	14	3000	24°	001	1,30	SCHW243KB
	N	14	4000	24°	001	1,30	SCHW244KB



### LED Shop windows C-W



	colour	W/max	K	△	
	B	5	3000	24°	SCHW243KCWW
	B	5	4000	24°	SCHW244KCWW
	N	5	3000	24°	SCHW243KCWB
	N	5	4000	24°	SCHW244KCWB

24°

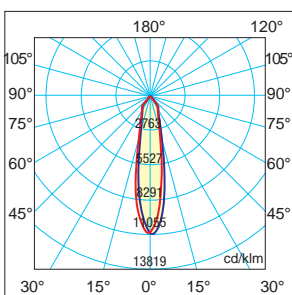

40°

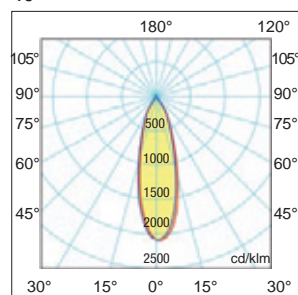

#### Taratura/Settings DIP-SWITCH

lout	mA	150	200	250	300	350
Lm	Lm output	600	800	1000	1200	1400
Power	W	6	8	10	12	14
Taratura standard di fabbrica Standard factory settings						

# LED Sirio - Venere - Cuculo





220 240V 50/60 Hz IK08 IP42 IP65 +40 C° -20 CE 850° DRIVER INCLUDED

RETAIL MARKET SCHOOL HOTEL HOSPITAL OFFICE GYM

Lampade d'emergenza  
Emergency lamps

Vedi/See pag.368

LED Sirio SE

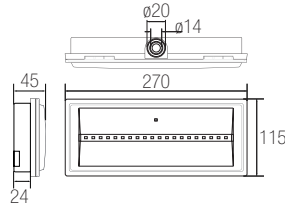

Accessori non inclusi - Not included accessories



Sirio R00335SXDX Euro 22,00

Sirio R00335DIR Euro 22,00

Sirio R00335EX Euro 22,00



Descrizione Description	Potenza* Power	Autonomia** Autonomy	Batteria Battery Ni-Cd		Ricarica Recharge	Flusso medio Average flow	n.-nr. LED	Assorb. max W SE	Code Code
	W	h.	Volt	Ah	h.	SE lm			
SIRIO IP42 11 SE 1H V I	11	1 (3)	3,6	0,8	12	150	20	2,7	1956L20REL
SIRIO IP42 11 SE 3H V I	11	3 (9)	3,6	1,6	24	150	20	2,9	1992L20REL
SIRIO IP42 18 SE 1H V I	18	1 (3)	3,6	1,6	24	400	20	3,5	2046LREL

220-240 Vac 50/60 Hz IP42 / IP65 IK08 850° +40 C° -20 CE

LED Venere SE

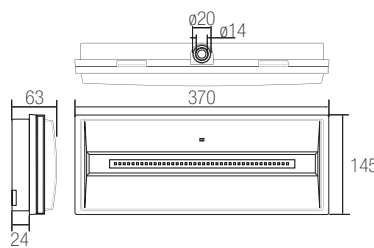

Accessori non inclusi - Not included accessories



Venere R00337SXDX Euro 25,00

Venere R00337DIR Euro 25,00

Venere R00337EX Euro 25,00



Descrizione Description	Potenza* Power	Autonomia** Autonomy	Batteria Battery Ni-Cd		Ricarica Recharge	Flusso medio Average flow	n.-nr. LED	Assorb. max W SE	Code Code
	W	h.	Volt	Ah	h.	SE lm			
VENERE IP42 24 SE 1H V I	24	1 (3)	3,6	1,6	12	240	40	2,9	12104L40REL
VENERE IP42 24 SE 3H V I	24	3 (9)	3,6	4,0	24	240	40	3,2	12104/3L40REL
VENERE IP42 24 SE 1H V I H	24	1	3,6	4,0	24	700	40	3,2	12104H40REL

110 a richiesta on demand Vac 220-240 Vac 50/60 Hz IP40 IK07 850° +40 C° -20 CE

LED Cuculo 503 SE - SA

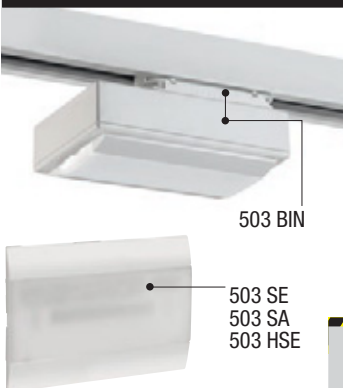

LED CUCULO IP40....

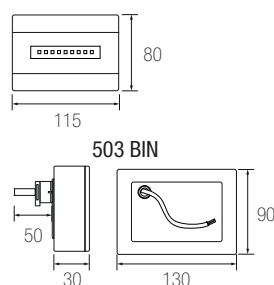

Accessori non inclusi - Not included accessories



503 BIN  
BOX + adattatore trifase  
Three-phase adapter+BOX

Descrizione Description	Potenza* Power	Versione Version	Autonomia** Autonomy	Batteria Battery Ni-Cd		Ricarica Recharge	Flusso medio Average flow		n° LED	Assorb. max W		Codice Code
	W		h.	Volt	Ah	h.	SE lm	SA lm		SE	SA	
CUCULO IP40 11 SE 1H V X	11	SE	1(3)	2,4	0,8	12	120	-	5	1,7	-	503SE
CUCULO IP40 11 SA-SE 1H V X	11	SE SA	1(3)	2,4	0,8	12	120	50	9	1,7	2,2	503SA
CUCULO IP40 11 SE 2H V H	11	SE	2(6)	2,4	1,6	24	120	-	5	1,9	-	503HSE

Esempio di installazione a binario trifase.  
Tree-phase track installation.

**Syros slim trifase dark light**

Apparecchio singolo e fila continua  
Single devices and continuous line

A RICHIESTA  
ON DEMAND

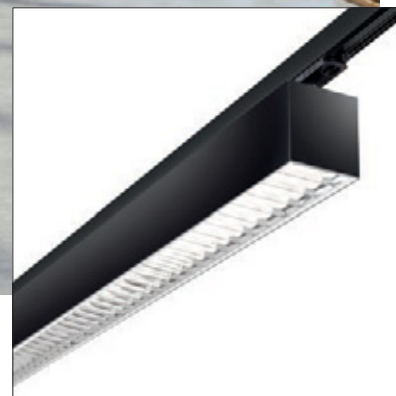

Track light

**LED Syros slim trifase, dark light.**

Sistema luminoso modulare per file continue per binario trifase in versione dark light, per uffici, reception, supermarket, palestre.

**Installazione:** a binario trifase.

**Corpo:** alluminio estruso anodizzato al naturale verniciato a polveri epossidiche bianco RAL 9010 e nero RAL 9005.

**Ottica dark Light:** parabola in alluminio 99,85, antiriflesso UGR<16 e antiridescente a bassissima luminanza.

**Conforme alla norma:** EN60598-1, RG0 nessun rischio fotobiologico ai fini della norma EN62471.

**Led: Samsung SMD** mantenimento del flusso luminoso minimo al 80%: 50.000h (L80B10).

**Driver multipotenza:** Incluso > 50.000 h Fattore di potenza ≥0,95.

**A richiesta:** per quantità si esegue il settaggio dedicato della corrente del Driver e di conseguenza la potenza di W e Lm.

**Prodotto conforme alle direttive:**

**LED Syros slim three-phase, dark light, opal, asymmetrical.**

Modular light system for three-phase track in dark light version, opal or with lenses, for offices, receptions, supermarkets, gyms.

**Installation:** Three-phase track.

**Body:** natural anodised aluminium painted with white RAL 9010 and black RAL 9005 epoxy powders.

**Dark light optics:** 99.85 aluminium parabola, antiglare UGR<16 and anti-iridescent, with very low luminance.

**Compliant with standard:** : EN60598-1, RG0 no photobiological risk for the purposes mentioned in standard EN62471.

**Led: Samsung SMD** maintenance of 80% minimum luminous flux: 50,000h (L80B10).

**Driver multipower:** Included > 50,000 h Power factor ≥0.95.

**On request:** for quantity, the dedicated setting of the Driver current and consequently the power of W and Lm is carried out.

**Product compliant with directives:**

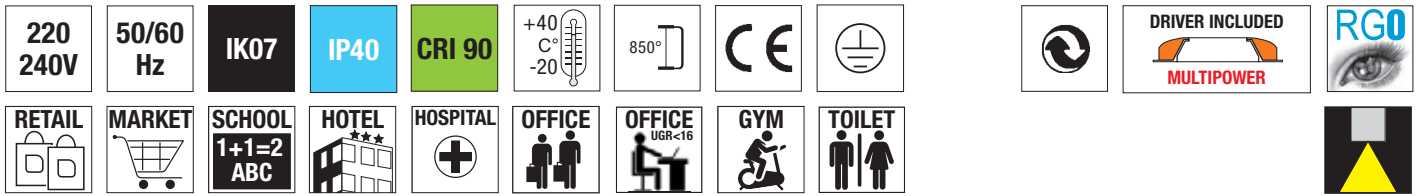

### 3S Syros slim system S-C trifase Dark-light

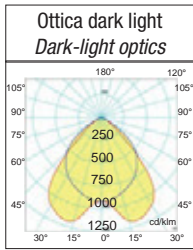
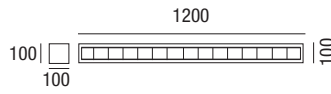

colour	W max	Vac	lm output	lm/W	K	pcs/pallets	Kg	CELL
B	40	220-240	5200	130	4000	60	4.50	25936/SL/PHDL
N	40	220-240	5200	130	4000	60	4.50	25936SLPHDLN
<b>DALI 2</b> PUSH B	40	220-240	5200	130	4000	60	4.50	25936SLPHDLDA
<b>DALI 2</b> PUSH N	40	220-240	5200	130	4000	60	4.50	25936SLPHDLN
B	60	220-240	7800	130	4000	60	4.50	25938/SL/PHDL
N	60	220-240	7800	130	4000	60	4.50	25938SLPHDLN
<b>DALI 2</b> PUSH B	60	220-240	7800	130	4000	60	4.50	25938SLPHDLDA
<b>DALI 2</b> PUSH N	60	220-240	7800	130	4000	60	4.50	25938SLPHDLN

### 3S Syros slim system trifase Opal

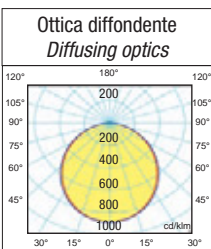
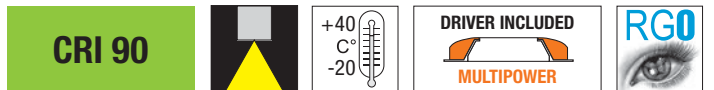
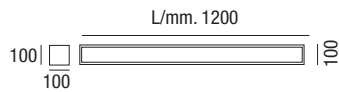

colour	W max	N°Led SMD	Vac	lm output	lm/W	K	L [mm]	pcs/pallets	Kg	CELL
B	40	504 led 3528	220-240	5000	125	4000	1.200	60	4.50	25940/SL/PHOP
N	40	504 led 3528	220-240	5000	125	4000	1.200	60	4.50	25940SLPHOPN
<b>DALI 2</b> PUSH B	40	504 led 3528	220-240	5000	125	4000	1.200	60	4.50	25940SLPHOPDA
B	60	504 led 3528	220-240	7500	125	4000	1.200	60	4.50	25942/SL/PHOP
N	60	504 led 3528	220-240	7500	125	4000	1.200	60	4.50	25942SLPHOPN
<b>DALI 2</b> PUSH B	60	504 led 3528	220-240	7500	125	4000	1.200	60	4.50	25942SLPHOPDA

# Sky system trifase

Apparecchio singolo e fila continua  
*Single devices and continuous line*

A RICHIESTA  
ON DEMAND

WIRELESS

0-10V

DALI 2



Track light

## LED Sky slim trifase, opale, asimmetrica e bi-asimmetrica.

Sistema luminoso modulare per file continue per binario trifase in versione opale o con lenti, uffici, reception, supermarket, palestre.

**Installazione:** a binario trifase.

**Corpo:** alluminio estruso anodizzato al naturale verniciato a polveri epossidiche bianco RAL 9010 e nero RAL 9005.

**Diffusore:** in policarbonato trasparente ad incastro a filo + film microstrutturato UGR<19.

**Diffusore asimmetrico e bi-asimmetrica:** lenti in PMMA e diffusore trasparente.

**Conforme alla norma:** EN60598-1, RG0 nessun rischio fotobiologico ai fini della norma EN62471.

**Led: Samsung SMD** mantenimento del flusso luminoso minimo al 80%: 50.000h (L80B10).

**Driver multipotenza:** Incluso > 50.000 h  Fattore di potenza ≥0,95.

**A richiesta:** per quantità si esegue il settaggio dedicato della corrente del Driver e di conseguenza la potenza di W e Lm.

**Prodotto conforme alle direttive:** 

## LED Sky slim three-phase, opal, asymmetrical, bi-asymmetrical.

Modular light system for continuous rows, for three-phase track, in opal version or with lenses, for offices, receptions, supermarkets, gyms.

**Installation:** Three-phase track.

**Body:** natural anodised extruded aluminium painted with white RAL 9010 and black RAL 9005 epoxy powders.

**Diffuser:** in flush joint transparent polycarbonate + microstructured film UGR <19.

**Asymmetric and bi-asymmetric diffuser:** lens in clear PMMA and transparent diffuser.

**Compliant with standard:** EN60598-1, RG0 no photobiological risk for the purposes mentioned in standard EN62471.

**Led: Samsung SMD** maintenance of 80% minimum luminous flux: 50,000h (L80B10).

**Multipower driver:** Included > 50,000 h  Power factor ≥0.95.

**On request:** for quantity, the dedicated setting of the Driver current and consequently the power of W and Lm is carried out.

**Product compliant with directives:** 

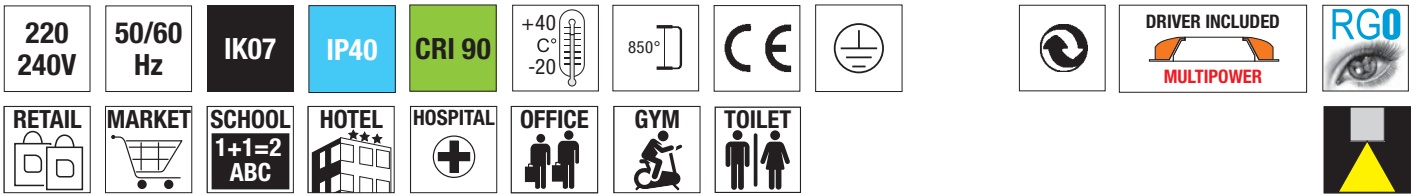

### Sky system trifase Opal

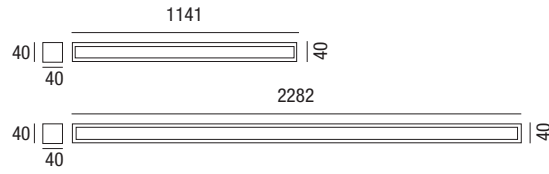
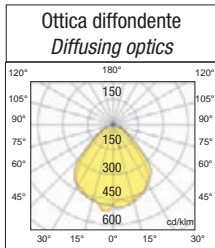

	colour	W max	Vac	lm output	lm/W	K	L (mm)	Kg	CELL
	B	30	220-240	3900	130	3000	1111	2.00	1003KPH
	B	30	220-240	3900	130	4000	1111	2.00	1004KPH
	DALI 2	B	30	220-240	3900	130	3000	2.00	1003KPHDA
	DALI 2	B	30	220-240	3900	130	4000	2.00	1004KPHDA
	N	30	220-240	3900	130	3000	1111	2.00	100B3KPH
	N	30	220-240	3900	130	4000	1111	2.00	100B4KPH
	DALI 2	N	30	220-240	3900	130	3000	2.00	100B3KPHDA
	DALI 2	N	30	220-240	3900	130	4000	2.00	100B4KPHDA
	B	50	220-240	6500	130	3000	2282	4.00	2003KPH
	B	50	220-240	6500	130	4000	2282	4.00	2004KPH
	DALI 2	B	50	220-240	6500	130	3000	4.00	2003KPHDA
	DALI 2	B	50	220-240	6500	130	4000	4.00	2004KPHDA
	N	50	220-240	6500	130	3000	2282	4.00	200B3KPH
	N	50	220-240	6500	130	4000	2282	4.00	200B4KPH
	DALI 2	N	50	220-240	6500	130	3000	4.00	200B3KPHDA
	DALI 2	N	50	220-240	6500	130	4000	4.00	200B4KPHDA

### Sky system trifase asimmetrica

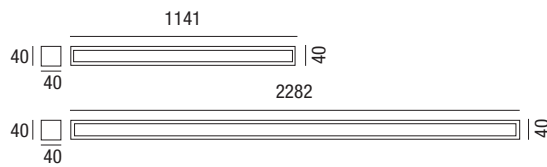
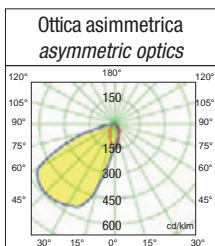

	colour	W max	Vac	lm output	lm/W	K	L (mm)	Kg	CELL
	B	30	220-240	3900	130	3000	1111	2.00	100AS3KPH
	B	30	220-240	3900	130	4000	1111	2.00	100AS4KPH
	DALI 2	B	30	220-240	3900	130	3000	2.00	100AS3KPHDA
	DALI 2	B	30	220-240	3900	130	4000	2.00	100AS4KPHDA
	N	30	220-240	3900	130	3000	1111	2.00	100ASB3KPH
	N	30	220-240	3900	130	4000	1111	2.00	100ASB4KPH
	DALI 2	N	30	220-240	3900	130	3000	2.00	100ASB3KPHDA
	DALI 2	N	30	220-240	3900	130	4000	2.00	100ASB4KPHDA
	B	50	220-240	6500	130	3000	2282	4.00	200AS3KPH
	B	50	220-240	6500	130	4000	2282	4.00	200AS4KPH
	DALI 2	B	50	220-240	6500	130	3000	4.00	200AS3KPHDA
	DALI 2	B	50	220-240	6500	130	4000	4.00	200AS4KPHDA
	N	50	220-240	6500	130	3000	2282	4.00	200ASB3KPH
	N	50	220-240	6500	130	4000	2282	4.00	200ASB4KPH
	DALI 2	N	50	220-240	6500	130	3000	4.00	200ASB3KPHDA
	DALI 2	N	50	220-240	6500	130	4000	4.00	200ASB4KPHDA

# Sky system trifase

## Sky system trifase bi-asimmetrica



UGR < 19

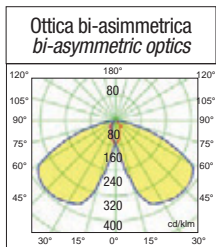
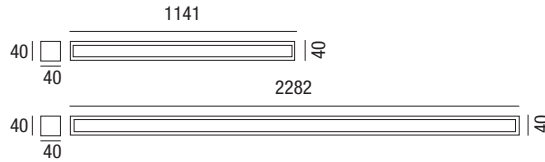

	colour	W max	Vac	lm output	lm/W	K	L [mm]	Kg	CELL
	B	30	220-240	3900	130	3000	1141	2.00	100BAS3KPH
	B	30	220-240	3900	130	4000	1141	2.00	100BAS4KPH
	DALI 2 B	30	220-240	3900	130	3000	1141	2.00	100BAS3KPHDA
	DALI 2 B	30	220-240	3900	130	4000	1141	2.00	100BAS4KPHDA
	N	30	220-240	3900	130	3000	1141	2.00	100BASB3KPH
	N	30	220-240	3900	130	4000	1141	2.00	100BASB4KPH
	DALI 2 N	30	220-240	3900	130	3000	1141	2.00	100BASB3KPHDA
	DALI 2 N	30	220-240	3900	130	4000	1141	2.00	100BASB4KPHDA
	B	50	220-240	6500	130	3000	2282	4.00	200BAS3KPH
	B	50	220-240	6500	130	4000	2282	4.00	200BAS4KPH
	DALI 2 B	50	220-240	6500	130	3000	2282	4.00	200BAS3KPHDA
	DALI 2 B	50	220-240	6500	130	4000	2282	4.00	200BAS4KPHDA
	N	50	220-240	6500	130	3000	2282	4.00	200BASB3KPH
	N	50	220-240	6500	130	4000	2282	4.00	200BASB4KPH
	DALI 2 N	50	220-240	6500	130	3000	2282	4.00	200BASB3KPHDA
	DALI 2 N	50	220-240	6500	130	4000	2282	4.00	200BASB4KPHDA



### Ottica asimmetrica Asymmetric optics

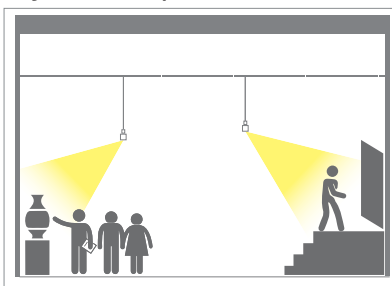

Ideale per l'illuminazione di pareti in modo uniforme.  
Ideal for lighting walls evenly.

### Ottica bi-asimmetrica Bi-asymmetric optics



Adatta per gli spazi commerciali al fine di dare maggior risalto alla merce esposta rispetto alle corsie.

Suitable for commercial spaces to allow the displayed goods to stand out respect to the lanes.

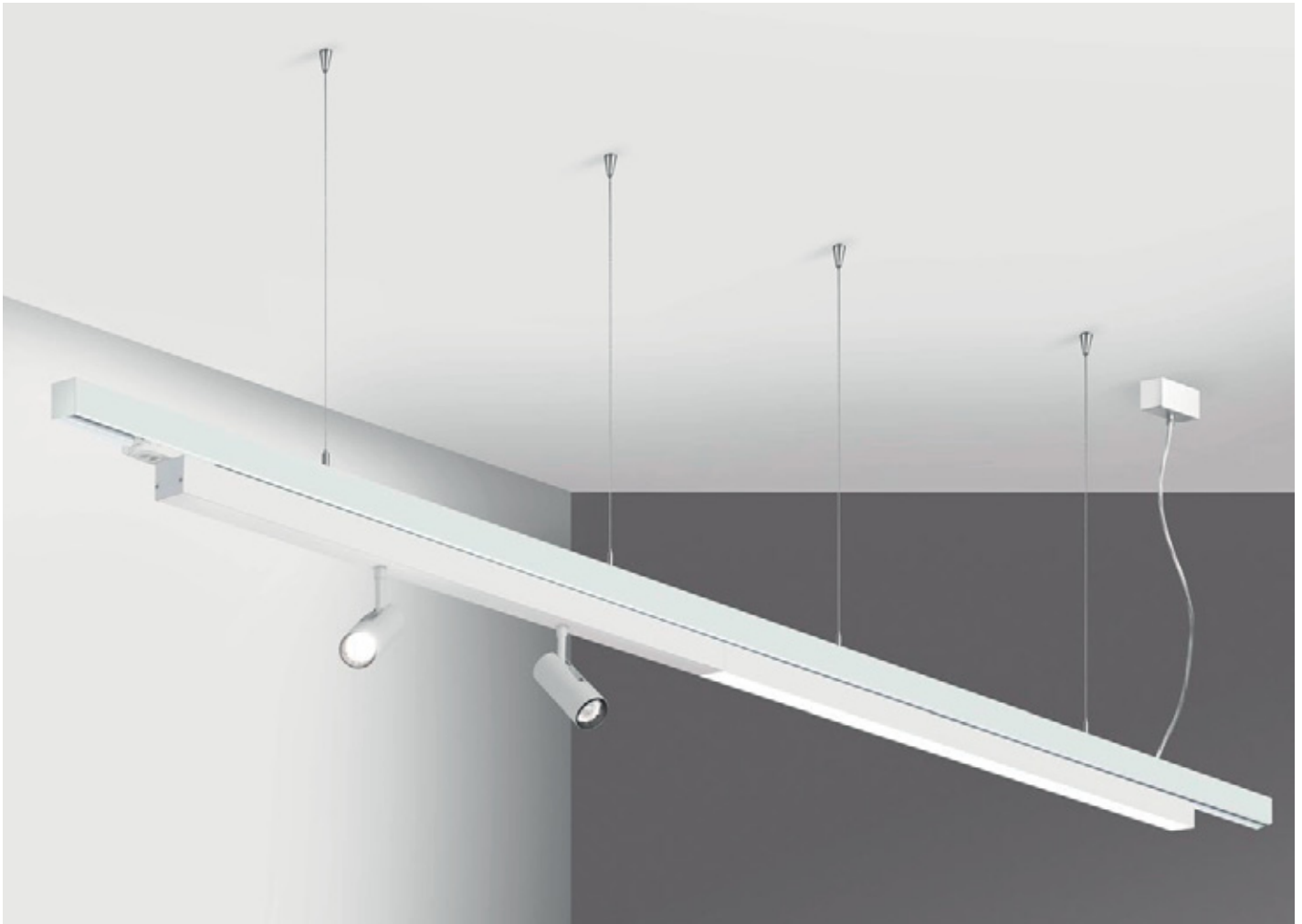

**Kit Spot**  
**Spot Kit**

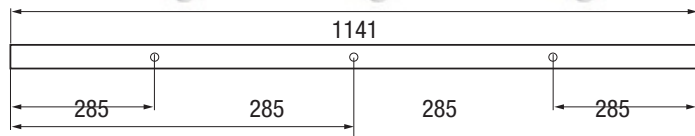
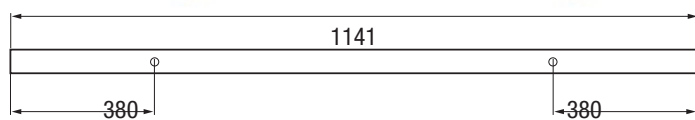
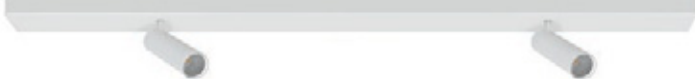

**Cover 2 spot L.1141 mm.**

Colour	W	lm output	K	Angolo	Code
B	2x10	2x1700	3000	15 (36)	2SPOT/3K/PH
B	2x10	2x1700	4000	15 (36)	2SPOT/4K/PH
N	2x10	2x1700	3000	15 (36)	2SPOT/B/3K/PH
N	2x10	2x1700	4000	15 (36)	2SPOT/B/4K/PH

**Cover 3 spot L.1141 mm.**

Colour	W	lm output	K	Angolo	Code
B	3x10	3x1700	3000	15 (36)	3SPOT/3K/PH
B	3x10	3x1700	4000	15 (36)	3SPOT/4K/PH
N	3x10	3x1700	3000	15 (36)	3SPOT/B/3K/PH
N	3x10	3x1700	4000	15 (36)	3SPOT/B/4K/PH

**Spot 15°**

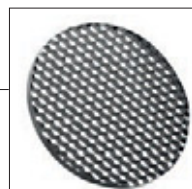
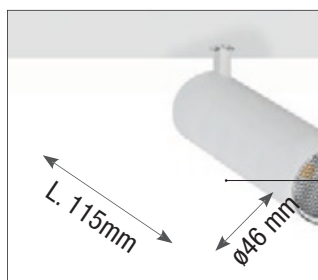
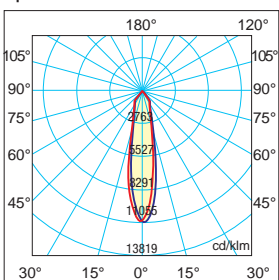

Frangiluce nido d'ape **INCLUSO**.  
**INCLUDED Honeycomb louvre**

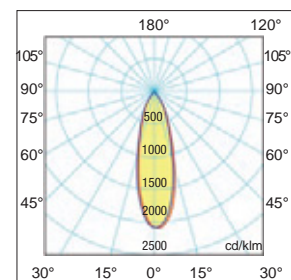

**Spot 36° a richiesta on demand**

# THREEPHASE TRACKS PLUS Professional

Binari trifase PLUS SC, plafone - *Threephase tracks PLUS SC, ceiling*



Binari trifase PLUS SC, sospensione - *Threephase tracks PLUS SC, suspended*



Binari trifase PLUS R, da incasso - *Threephase tracks PLUS R, recessed*





# Binari trifase PLUS S-C-R - Threephase tracks PLUS S-C-R

Binari trifase PLUS SC, sospensione e plafone  
Threephase tracks PLUS SC, suspended or ceiling



Binari trifase PLUS R, incasso  
Recessed threephase tracks PLUS R



## UN UNICO BINARIO PER TUTTE LE TUE IDEE DI LUCE

I nuovi binari Relco sono **TRIFASE PLUS**, incorporano cioè in un unico prodotto le funzionalità delle tre tipologie di binari EUROSTANDARD presenti sul mercato e sono quindi una soluzione **economicamente vantaggiosa** e con un grande valore aggiunto. Questi binari sono infatti l'investimento giusto per ogni tipo di progetto perché garantiscono la **compatibilità** con tutti i sistemi ad oggi sul mercato e lasciano la libertà di scegliere in un secondo momento la tipologia di sistema di illuminazione da adottare, dando quindi la **massima flessibilità progettuale presente e futura**. I binari TRIFASE PLUS® di Relco sono approvati FELV, prodotti in alluminio estruso con contatti in rame e parti plastiche in PVC. Sono disponibili in versione standard o da controsoffitto in due diverse colorazioni: Bianco e Nero.

## JUST ONE TRACK FOR ALL YOUR LIGHTING IDEAS

New Relco track system is **THREEPHASE TRACK PLUS**, it combines the functionalities of the three EUROSTANDARD tracks currently available in the market in one unique product and is therefore a **convenient solution** with a **great added value**. In fact this system is the right investment for all the kinds of projects because it guarantees **compatibility** with all the existing systems. At the same time mounting this system allows the end user to select the type of luminaire at any phase of the project, thus bringing present and future **flexibility in lighting projects**.

Relco THREEPHASE TRACK PLUS track system is FELV tested and approved. It is manufactured in extruded aluminium with copper contacts and pvc plastic parts. It is available in two colours: White and Black, both in standard and recessed versions. **On request: hidden in-built track**

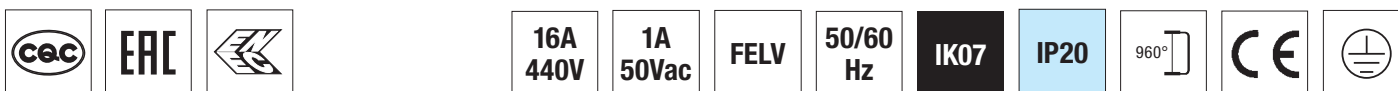

## BINARIO S-C, A 6 CONDUTTORI EUROSTANDARD PLUS - EUROSTANDARD PLUS 6-CONDUCTOR TRACK

Colour	A	mm	pcs	Kg	Code
B	16	1000	001	1,10	9000A-1/W-ST
N	16	1000	001	1,10	9000A-1/B-ST
B	16	2000	001	2,10	9000A-2/W-ST
N	16	2000	001	2,10	9000A-2/B-ST
B	16	3000	001	3,40	9000A-3/W-ST
N	16	3000	001	3,40	9000A-3/B-ST

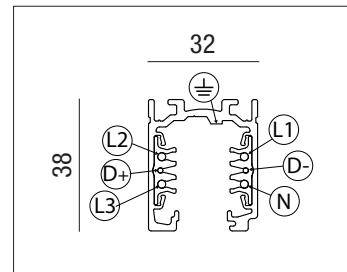
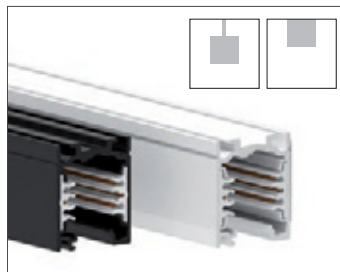

## BINARIO R, A 6 CONDUTTORI EUROSTANDARD PLUS DA INCASSO - RECESSED EUROSTANDARD PLUS 6-CONDUCTOR TRACK R

Colour	A	mm	pcs	Kg	Code
B	16	1000	001	1,10	9000-1/W-R
N	16	1000	001	1,10	9000-1/B-R
B	16	2000	001	2,10	9000-2/W-R
N	16	2000	001	2,10	9000-2/B-R

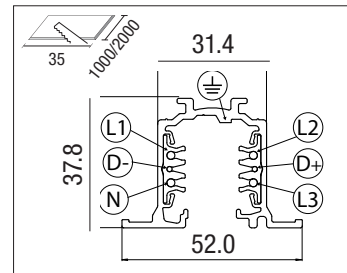
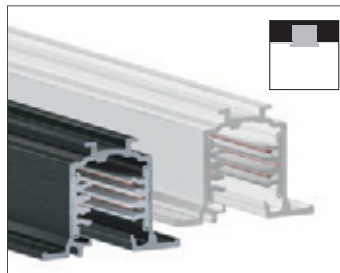

Versione per controsoffitto disponibile con l'utilizzo degli appositi accessori.  
Recessed version available with specific accessories.

## Adattatore simmetrico con selettore di fase Symmetrical adapter with phase selector

Colour	A	connectors	pcs	Kg	Code
B	max 10Kg	4	010	0,05	9009-4/W
B	max 10Kg	6	010	0,05	9209/W
B	Nippel per sospensione				S-9009/BC-W

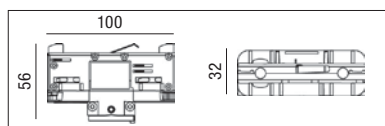

## Adattatore meccanico Mechanical adapter

Colour	pcs	Kg	Code	
B	max 15Kg	010	0,02	S-9000/M-W
N	max 15Kg	010	0,02	S-9000/M-B

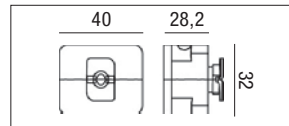

**Tutti gli accessori sono compatibili con binari trifase plus a plafone, sospensione ed incasso.**  
**All accessories are compatible with three-phase plus surface-mounted, suspended and recessed tracks.**

Tutte le connessioni sono realizzate in policarbonato autoestinguente con glow wire 960°C. Le connessioni sono disponibili in tutte le versioni necessarie per la composizione di un sistema di illuminazione complesso (posizionamento fase interno/esterno, dx/sx, come segnalato nel disegno del singolo articolo dall'apposita linea rossa Fig.1).

All connections are made of self-extinguishing polycarbonate, glow wire 960°C. Connections are available in all versions that allow the construction of a complete lighting application (internal/external, R/L phase placement as per red line in the singular drawing Fig.1).

→ polarità - vista dall'alto  
 polarity ridge - floor view

### Giunto lineare Linear Joint

Colour	A	pcs	Kg	Code
B	16	010	0,05	9003/W
N	16	010	0,05	9003/B

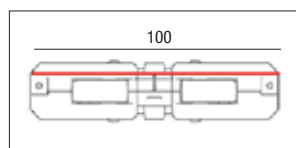

### Tappo di chiusura - End cap

Colour	pcs	Kg	Code
B	010	0,08	9004/W
N	010	0,08	9004/B



### Giunto diretto Middle feed

Colour	A	pcs	Kg	Code
B	16	010	0,20	9010/W
N	16	010	0,20	9010/B

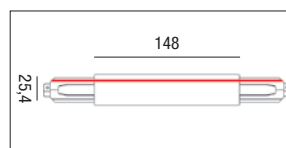

### Giunto X - X Joint

Colour	A	pcs	Kg	Code
B	16	010	0,38	9017/W
N	16	010	0,38	9017/B

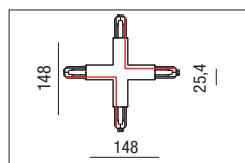

### Giunto L - L Joint

Colour	A	pcs	Kg	DX	SX
B	16	010	0,20	9011/W	9012/W
N	16	010	0,20	9011/B	9012/B

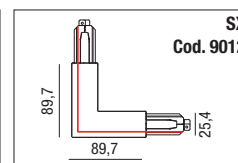
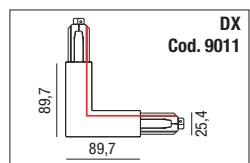

### Giunto T - T Joint

Colour	A	pcs	Kg	INT. SX *	INT. DX *
B	16	010	0,29	9016/W	9015/W
N	16	010	0,29	9016/B	9015/B

Colour	A	pcs	Kg	EXT. SX *	EXT. DX *
B	16	010	0,29	9014/W	9013/W
N	16	010	0,29	9014/B	9013/B

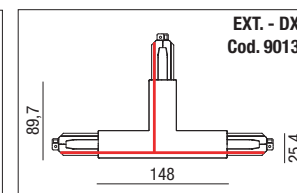
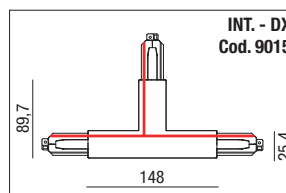
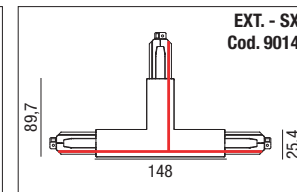
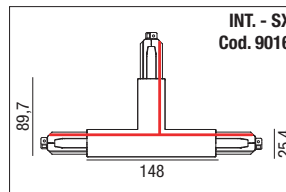

**Importante:** per il collegamento degli altri componenti tenere le polarità nella stessa posizione. La dicitura interno/esterno sta ad indicare la posizione del cavo negativo del DALI rispetto al componente.

**Important:** to connect all the other components, the polarity must be kept in the same position. The lettering Internal/External refers to the position of the negative connector for the DALI respectively to the components

**N.B:** Nel giunto interno il cavo Dali negativo passa all'interno.

**N.B:** In the internal joint, the negative DALI cable goes from within.

**N.B:** Nel giunto esterno il cavo Dali negativo passa all'esterno.

**N.B:** In the external joint, the negative DALI cable goes from the outside.

### Giunto flessibile - Adjustable corner

Colour	A	pcs	Kg	Code
B	16	010	0,24	9018/W
N	16	010	0,24	9018/B

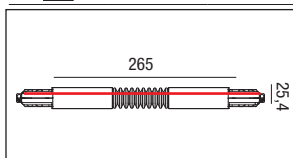

### Testata - Live end

Colour	A	pcs	Kg	SX*	DX*
B	16	010	0,10	9001/W	9002/W
N	16	010	0,10	9001/B	9002/B

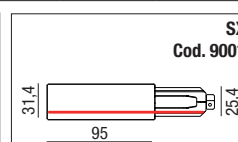
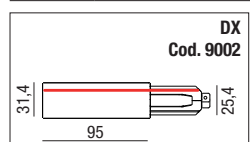

# Esempio di composizione - Example of composition

## BINARIO S-C, A 6 CONDUTTORI EUROSTANDARD PLUS EUROSTANDARD PLUS 6-CONDUCTOR TRACK

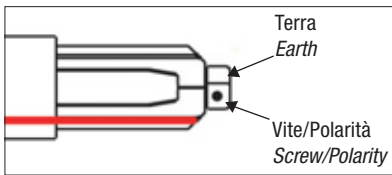
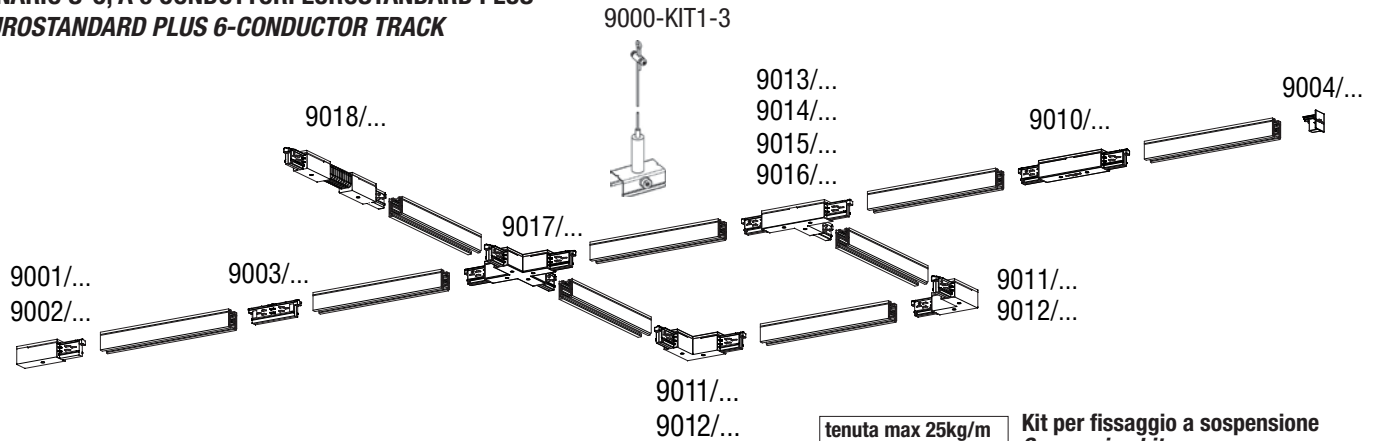

\* I riferimenti SX e DX sono dati in base alla posizione della testa della vite sulla polarità.  
SX and SX references are given having as a base the head of the screw on the polarity.

tenuta max 25kg/m  
max hold 25kg / m



### Kit per fissaggio a sospensione Suspension kit

Cod. **9000-KIT1-3**

Kit per fissaggio a sospensione composto da:

- Tenditore a vite
- Filo in acciaio Ø 1,5mm
- Lunghezza 3m
- Clip con tenditore automatico

Complete suspension Kit composed by:

- Screw gripper
- Steel cable Ø 1,5mm
- Lenght 3m
- Clamp with automatic gripper

## BINARIO R, A 6 CONDUTTORI EUROSTANDARD PLUS DA INCASSO RECESSED EUROSTANDARD PLUS 6-CONDUCTOR TRACK R

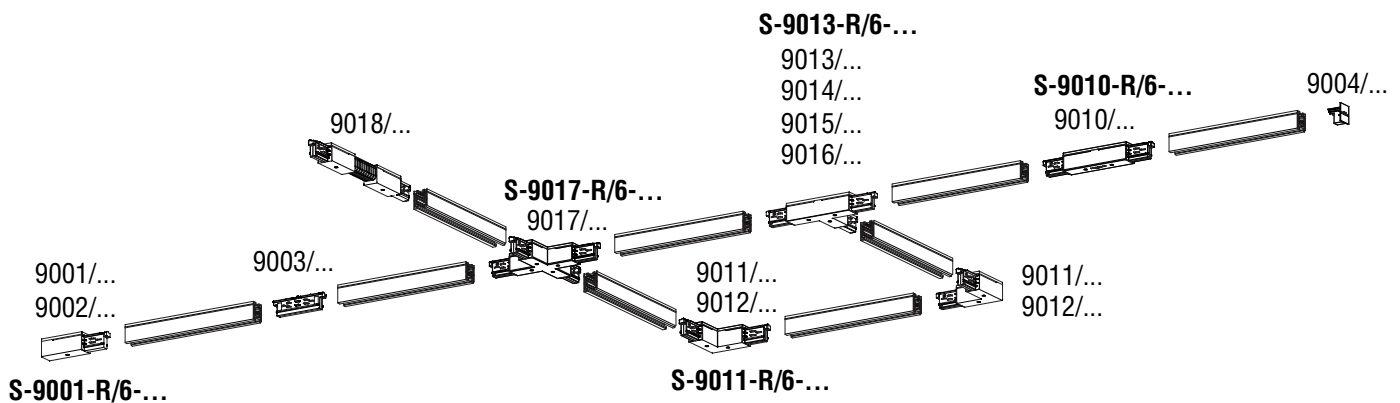

### ACCESSORI CONNESSIONI BINARIO R, INCASSO CONNECTION ACCESSORIES RECESSED TRACK

R = INCASSO / RECESSED W = **B** B = **N**

#### Copertura per testata - Cover for end feed

Colour	pcs	Kg	Code
<b>B</b>	010	0,026	S-9001-R/6-W
<b>N</b>	010	0,026	S-9001-R/6-B



#### Copertura per giunto diretto - Cover for middle feed

Colour	pcs	Kg	Code
<b>B</b>	010	0,08	S-9010-R/6-W
<b>N</b>	010	0,08	S-9010-R/6-B

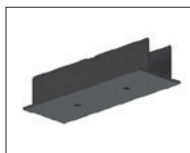

#### Copertura per giunto a L- Cover for L-feed

Colour	pcs	Kg	Code
<b>B</b>	010	0,08	S-9011-R/6-W
<b>N</b>	010	0,08	S-9011-R/6-B

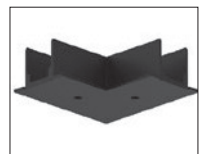

#### Copertura per giunto a T- Cover for T-feed

Colour	pcs	Kg	Code
<b>B</b>	010	0,08	S-9013-R/6-W
<b>N</b>	010	0,08	S-9013-R/6-B

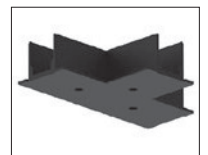

#### Copertura per giunto a X- Cover for X-feed

Colour	pcs	Kg	Code
<b>B</b>	010	0,08	S-9017-R/6-W
<b>N</b>	010	0,08	S-9017-R/6-B

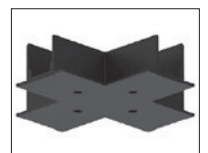

# LED Audace C-W-R



Serie di proiettori a plafone (C), parete (W) o semincasso (R) orientabili progettati per illuminare ambienti dove è necessaria un'illuminazione generale e d'accento.

**Installazione:** a soffitto e/o parete.

**Corpo:** in alluminio pressofuso UNI 5076, verniciato con polvere termoindurente poliestere.

**Verniciatura:** di tipo poliestere eseguita a polvere.

Colore nero RAL 9005 o Bianco RAL 9010.

**Ottica:** semi concentrante a 36° (a richiesta 12°, 24° o 45°).

**Schermo:** vetro temperato di spessore 3mm.

**Driver:** dimmerabile 0-10V, incorporato (versioni W/C)

**Conforme alla norma:** EN60598-1, RG0 nessun rischio fotobiologico ai fini della norma EN62471.

**Led:** LUMILEDS - PHILIPS mantenimento del flusso luminoso minimo al 80%: 50.000h (L80B10).

*Series of ceiling or semi-recessed adjustable projectors designed to light up place that requires general and spot lighting.*

**Installation:** ceiling and / or wall.

**Body:** made by UNI 5076 die-cast aluminum, coated with polyester thermoset powder.

**Coating:** coated with powdered polyester. RAL 9005 black or RAL 9010 white color.

**Optic:** semi-clumping at 36° (on request 12°, 24° o 45°).

**Shield:** tempered glass with 3mm thickness.

**Driver:** dimmable 0-10V included (W/C version).

**According to standard:** EN60598-1, RG0 exempt from photo-biological risks in compliance with standard EN62471.

**Led:** LUMILEDS - PHILIPS maintenance of minimum luminous flux to 80%: 50.000h (L80B10).

## Orientabilità - Adjustability



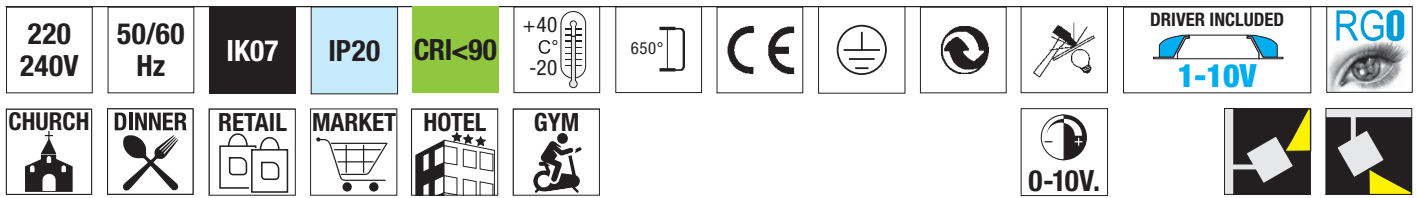

### LED Audace C-W

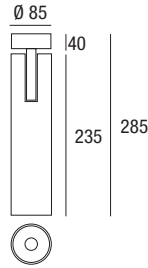

	colour	W	lm output	K		pcs	Kg	CELL
<b>0-10V</b>	B	32	3840	3000	40°	001	1,44	32928/010
<b>0-10V</b>	B	32	3840	4000	40°	001	1,44	32928/010/4K
<b>0-10V</b>	N	32	3840	3000	40°	001	1,44	32929/010
<b>0-10V</b>	N	32	3840	4000	40°	001	1,44	32929/010/4K

### LED Audace R

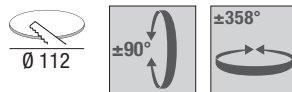
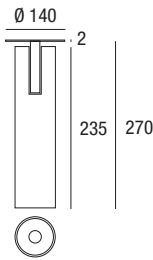

	colour	W	lm output	K		pcs	Kg	CELL
<b>0-10V</b>	B	32	4160	3000	40°	001	1,44	32930/010
<b>0-10V</b>	B	32	4160	4000	40°	001	1,44	32930/010/4K
<b>DALI 2 PUSH</b>	B	32	4160	3000	40°	001	1,44	32930/DA
<b>DALI 2 PUSH</b>	B	32	4160	4000	40°	001	1,44	32930/DA/4K



# LED Primavera C-W-R

A RICHIESTA  
ON DEMAND

0-10V



WIRELESS



Serie di proiettori a plafone (C), parete (W) o semincasso (R) orientabili progettati per illuminare ambienti dove è necessaria un'illuminazione generale e d'accento.

**Installazione:** a soffitto, parete o semincasso.

**Corpo:** in alluminio pressofuso UNI 5076, verniciato con polvere termoindurente poliestere.

**Verniciatura:** di tipo poliestere eseguita a polvere.

Colore nero RAL 9005 o Bianco RAL 9010.

**Ottica:** semi concentrante a 36° (a richiesta 12°, 24° o 45°).

**Schermo:** vetro temperato di spessore 3mm.

**Driver Multipower:** incluso

**Conforme alla norma:** EN60598-1, RG0 nessun rischio fotobiologico ai fini della norma EN62471.

**Led:** LUMILEDS - PHILIPS mantenimento del flusso luminoso minimo al 80%: 50.000h (L80B10).

*Series of ceiling or semi-recessed adjustable projectors designed to light up place that requires general and spot lighting.*

*Installation:* ceiling, wall or semi-recessed.

*Body:* made by UNI 5076 die-cast aluminum, coated with polyester thermoset powder.

*Coating:* coated with powdered polyester. RAL 9005 black or RAL 9010 white color.

*Optic:* semi-clumping at 36° (on request 12°, 24° o 45°).

*Shield:* tempered glass with 3mm thickness.

*Driver Multipower:* included.

*According to standard:* EN60598-1, RG0 exempt from photobiological risks in compliance with standard EN62471.

*Led:* LUMILEDS - PHILIPS maintenance of minimum luminous flux to 80%: 50.000h (L80B10).

Rotazione  
Rotation

±358°



±90°



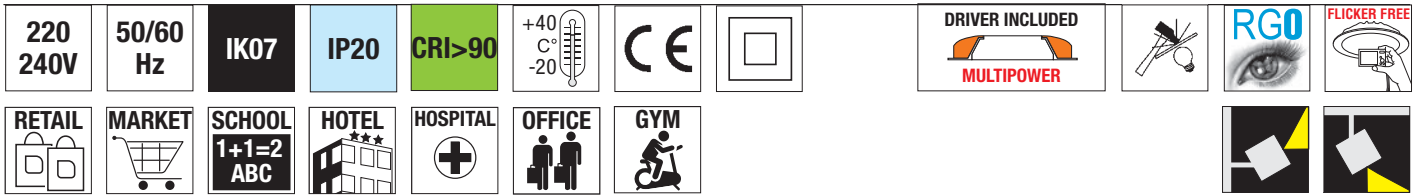

### LED Primavera C-W

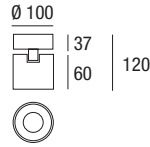

colour	W	lm output	K	△	pcs	Kg	CELL
B	30	3900	3000	40°	001	1,44	PRV303KWCV
B	30	3900	4000	40°	001	1,44	PRV304KWCV
<b>DALI 2</b> PUSH B	30	3900	3000	40°	001	1,44	PRV303KWCVDA
<b>DALI 2</b> PUSH B	30	3900	4000	40°	001	1,44	PRV304KWCVDA
N	30	3900	3000	40°	001	1,44	PRV303KBCV
N	30	3900	4000	40°	001	1,44	PRV304KBCV
<b>DALI 2</b> PUSH N	30	3900	3000	40°	001	1,44	PRV303KBCVDA
<b>DALI 2</b> PUSH N	30	3900	4000	40°	001	1,44	PRV304KBCVDA

### LED Primavera RR

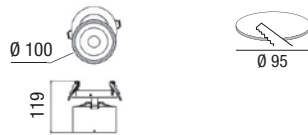

colour	W	lm output	K	△	pcs	Kg	CELL
B	30	3900	3000	40°	001	1,44	PRV303KWRR
B	30	3900	4000	40°	001	1,44	PRV304KWRR
<b>DALI 2</b> PUSH B	30	3900	3000	40°	001	1,44	PRV303KWRRDA
<b>DALI 2</b> PUSH B	30	3900	4000	40°	001	1,44	PRV304KWRRDA
N	30	3900	3000	40°	001	1,44	PRV303KBRR
N	30	3900	4000	40°	001	1,44	PRV304KBRR
<b>DALI 2</b> PUSH N	30	3900	3000	40°	001	1,44	PRV303KBRRDA
<b>DALI 2</b> PUSH N	30	3900	4000	40°	001	1,44	PRV304KBRRDA

# LED Primadonna C-W



Serie di proiettori orientabili progettati per illuminare spazi commerciali (supermercati, grandi magazzini, retail, ecc.), uffici e qualsiasi ambiente dove è necessaria un'illuminazione generale e d'accento.

**Installazione:** a soffitto e parete (completo di basetta di fissaggio).

**Corpo:** in alluminio pressofuso UNI 5076, verniciato con polvere termoindurente poliester.

**Verniciatura:** di tipo poliester eseguita a polvere. Colore nero RAL 9005 o Bianco RAL 9010.

**Ottica:** semi concentrante (a richiesta concentrante).

**Schermo:** vetro temperato di spessore 3mm.

**Driver:** incorporato.

**Conforme alla norma:** EN60598-1, RG0 nessun rischio fotobiologico ai fini della norma EN62471.

**Led:** LUMILEDS - PHILIPS mantenimento del flusso luminoso minimo al 80%: 50.000h (L80B10).

*Series of adjustable projectors designed to light up retail spaces (supermarkets, department stores, shops, etc.), offices and any other place that requires general and spot lighting.*

**Installation:** for ceiling and wall use (complete with fixing base).

**Body:** made by UNI 5076 die-cast aluminum, coated with polyester thermoset powder.

**Coating:** coated with powdered polyester. RAL 9005 black or RAL 9010 white color.

**Optic:** semi-clumping (clumping on demand).

**Shield:** tempered glass with 3mm thickness.

**Driver:** included.

**According to standard:** EN60598-1, RG0 exempt from photo-biological risks in compliance with standard EN62471.

**Led:** LUMILEDS - PHILIPS maintenance of minimum luminous flux to 80%: 50.000h (L80B10).

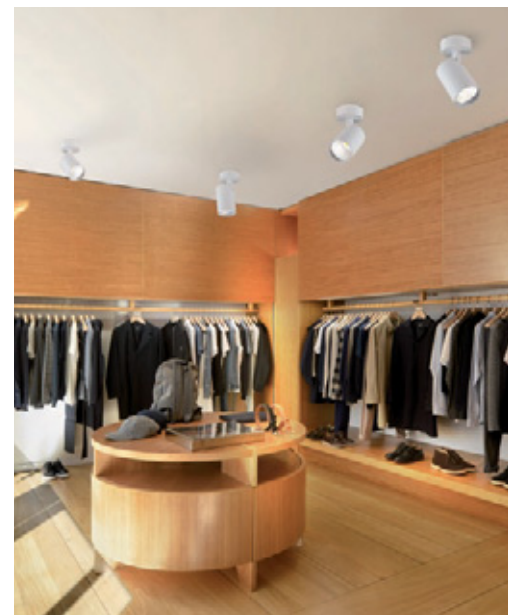

## Orientabilità - Adjustability





220 240V	50/60 Hz	IK07	IP20	CRI<90	+40 C -20	650°	CE				DRIVER INCLUDED	RG0
CHURCH	DINNER	RETAIL	MARKET	HOTEL	GYM	A richiesta: dimmerabile On demand: dimmable						

### LED Primadonna C-W



20W

Ø 90

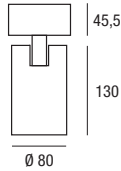

30W

Ø 120

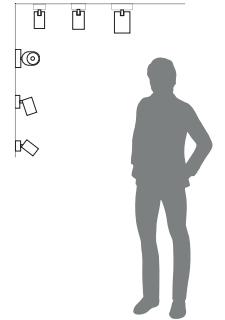
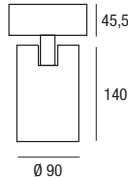

60W

Ø 160

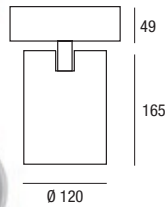

colour	W	lm output	K	△	△ on demand	pcs	Kg	CELL
B	20	2600	3000	40°	24°	001	1,40	32924/20
B	30	3900	3000	40°	24°	001	1,40	32924/30
B	30	3900	4000	40°	24°	001	1,40	32924/30/4K
N	30	3900	4000	40°	24°	001	1,40	32925/30/4K
B	60	7800	3000	40°	24°	001	1,55	32924/60
B	60	7800	4000	40°	24°	001	1,55	32924/60/4K
N	60	7800	3000	40°	24°	001	1,55	32935/60

### LED Primadonna Meat & Vegetables

A richiesta - On demand



Ceiling/wall

# LED Pop W -WD - F



Nero satinato  
Satin black



Grigio satinato  
Satin grey



A richiesta - On request

Rosso Ferrari  
Ferrari red



Oro satinato  
Satin gold



Versioni dimmerabili a Triac con sovrapprezzo 10% ( RN1483).  
*TRIAC versions with 10% extra charge (RN1483).*



LED Driver a spina dimmerabile per versione piantana LED POP F con sovrapprezzo 10% ( RN1515SILENCE).  
*Dimmable Plug LED Driver for LED POP F floor version with 10% surcharge (RN1515SILENCE).*

Versioni colori rosso ferrari, oro satinato sovrapprezzo 30% tempo di consegna 45gg.  
*Ferrari red, satin gold, versions 30% extra charge. Delivery time 45 days.*

Apparecchio di illuminazione a led per installazione fissa a parete che trova la propria corretta applicazione in locali dove è richiesto un punto a luce diffusa verso l'alto, verso il basso oppure in entrambe le direzioni. Il design minimale e discreto lo rende adatto ad ogni ambiente. Grazie ad un semplice cut off meccanico posto sul corpo della lampada, è possibile la regolazione angolare del fascio luminoso emesso.

**Installazione:** a parete (completo di basetta di fissaggio).

**Corpo:** in alluminio pressofuso UNI 5076, verniciato con polvere termoindurente poliestere.

**Verniciatura:** di tipo poliestere eseguita a polvere. Colore nero RAL 9005, Bianco RAL 9010 o grigio RAL 9006.

**Verniciatura a richiesta:** Colore oro satinato o rosso Ferrari.

**Ottica:** diffondente.

**Schermo:** vetro temperato di spessore 3mm.

**Driver:** incorporato.

**Conforme alla norma:** EN60598-1, RG0 nessun rischio fotobiologico ai fini della norma EN62471.

*LED lighting fixture for fixed wall installation that finds its correct application in rooms where a point of diffused light upwards, downwards or in both directions is required. The minimal and discreet design makes it suitable for any environment.*

*Thanks to a simple mechanical cut-off placed on the body of the lamp, it is possible to adjust the angle of the emitted light beam.*

**Installation:** on the wall (complete with fixing base).

**Body:** in die-cast aluminum UNI 5076, painted with thermosetting polyester powder.

**Coating:** polyester powder type. Black RAL 9005, White RAL 9010 or gray RAL 9006.

**Coating on request:** Satin gold or rosso Ferrari color.

**Optic:** wide beam.

**Screen:** 3mm thick tempered glass.

**Driver:** built-in.

**Compliant with standard:** EN60598-1, RG0 no photobiological risk for the purposes of standard EN62471.

220 240V	50/60 Hz	IK07	IP20	CRI<90	+40 C° -20	650°	CE				DRIVER INCLUDED	RG0
CHURCH	DINNER	RETAIL	HOTEL	GYM	OFFICE	<b>A richiesta: dimmerabile</b> <b>On demand: dimmable</b>						

### LED Pop W

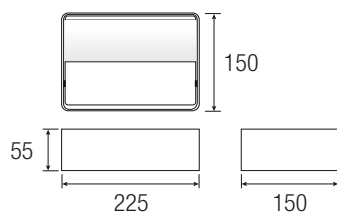

colour	W	lm output	K	Lm/W	pcs	Kg	CELL
B	18	2700	3000	157	001	1,50	558117-3KB
B	18	2700	4000	157	001	1,50	558117-4KB
N	18	2700	3000	157	001	1,50	558117-3KN
N	18	2700	4000	157	001	1,50	558117-4KN
G	18	2700	3000	157	001	1,50	558117-3KG
G	18	2700	4000	157	001	1,50	558117-4KG

### LED Pop double W

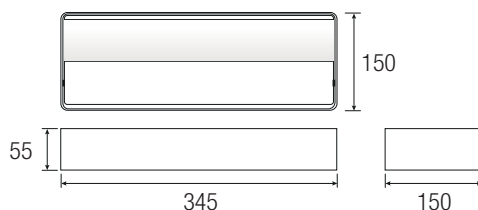

colour	W	lm output	K	Lm/W	pcs	Kg	CELL
B	36	5400	3000	157	001	3,00	558118-3KB
B	36	5400	4000	157	001	3,00	558118-4KB
N	36	5400	3000	157	001	3,00	558118-3KN
N	36	5400	4000	157	001	3,00	558118-4KN
G	36	5400	3000	157	001	3,00	558118-3KG
G	36	5400	4000	157	001	3,00	558118-4KG

### Orientabilità - Adjustability

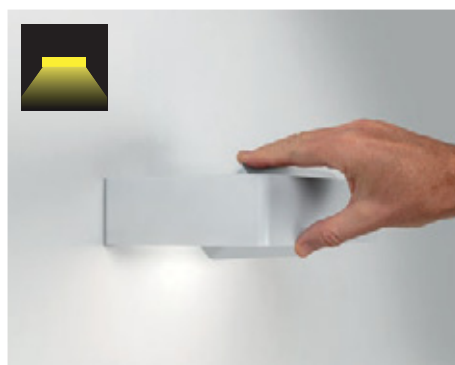



### LED Pop WD

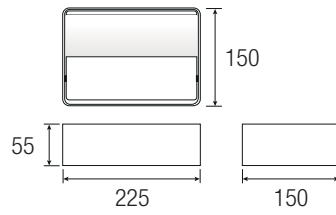

colour	W	lm output	K	Lm/W	pcs	Kg	CELL
B	18	2700	3000	157	001	1,50	558119-3KB
B	18	2700	4000	157	001	1,50	558119-4KB
N	18	2700	3000	157	001	1,50	558119-3KN
N	18	2700	4000	157	001	1,50	558119-4KN

### LED Pop double WD

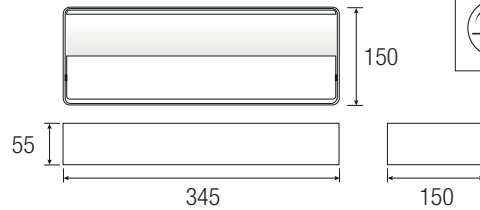

colour	W	lm output	K	Lm/W	pcs	Kg	CELL
B	36	5400	3000	157	001	3,00	558120-3KB
B	36	5400	4000	157	001	3,00	558120-4KB
N	36	5400	3000	157	001	3,00	558120-3KN
N	36	5400	4000	157	001	3,00	558120-4KN

Pop a parete con cavo, driver a spina e regolazione incorporata.  
 Wall-mounted pop with plug-in driver and built-in regulation.

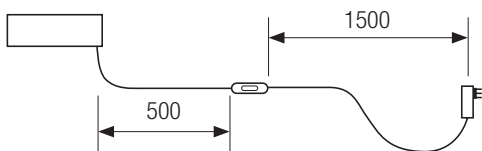

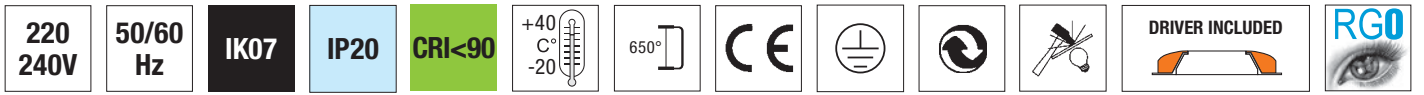

LED Pop F

**NEW**



colour	W	lm output	K	Lm/W	pcs	Kg	CELL
B	18	2700	3000	157	001	1,50	558121-3KB
B	18	2700	4000	157	001	1,50	558121-4KB
N	18	2700	3000	157	001	1,50	558121-3KN
N	18	2700	4000	157	001	1,50	558121-4KN

Pop piantana con cavo, driver a spina e regolazione incorporata.  
Floor-mounted pop with plug-in driver and built-in regulation.

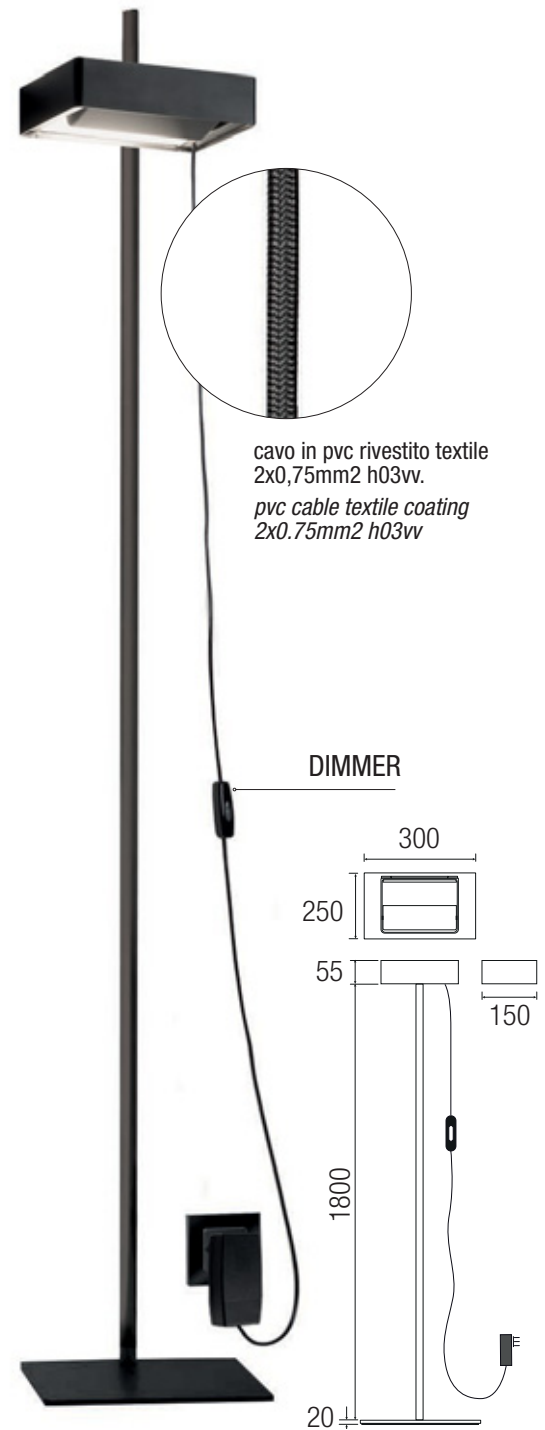

# Gesso ceramico W



Serie di applique in gesso a forma di mezza luna o rettangolari con vetro satinato e duplice diffusione della luce.

Il fascio luminoso bidirezionale di questi modelli crea incantevoli effetti scenici, concedendo ampia libertà progettuale.

Prodotti versatili, dal design essenziale, verniciabili, semplici da coordinare ed integrare agli interni in base alle necessità progettuali e ai gusti personali.

Complete di portalampada E27.

*Series of half moon or rectangular wall lamps in plaster with frosted glass and double light diffusion.*

*The bidirectional light beam of these models creates enchanting scenic effects, allowing ample design freedom.*

*Versatile products, with an essential design, easy to paint, easy to coordinate and integrate with the interiors according to the design needs and personal tastes.*

*Complete with E27 lamp holder.*

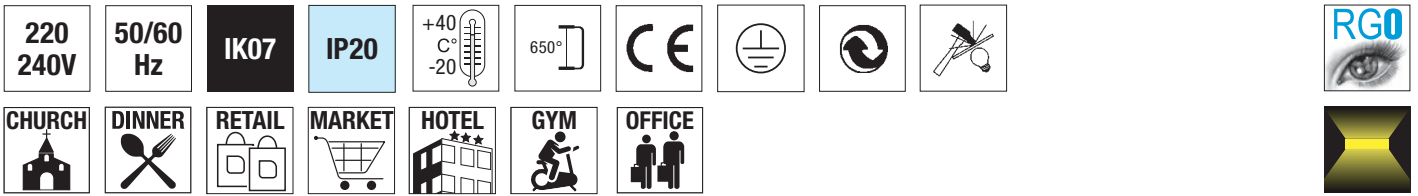

### Gipsy Mezzaluna 35

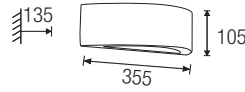

colour		pcs	Kg	S
B	E27	001	1,50	2410/N

### Gipsy Mezzaluna60

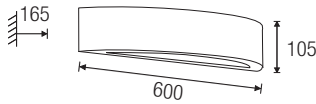

colour		pcs	Kg	S
B	2XE27	001	2,00	2411

### Gipsy Rettangolare 30

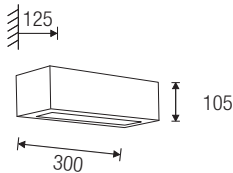
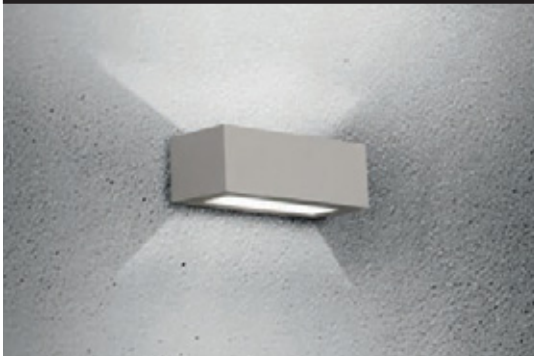

colour		pcs	Kg	S
B	E27	001	2,00	2206

### Gipsy Rettangolare 70

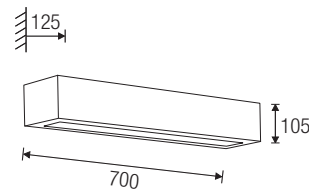

colour		pcs	Kg	S
B	2XE27	001	3,00	2208

# LED Huitre W

**NEW 2023**

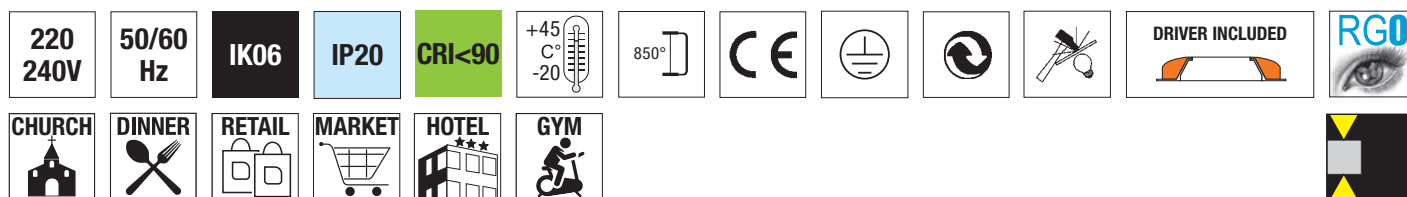

LED Huitre è una lampada da parete up & down di forma ovale per interni con driver integrato.

**Sorgente:** LED SMD ad alta luminosità.

**Corpo:** in alluminio ADC12 che offre un'ottima gestione termica.

**Verniciatura:** Nero RAL 9005.

**Riflettore:** il riflettore per PC può essere personalizzato in diversi colori (il colore standard è bianco).

È disponibile un CCT intercambiabile con interruttore a scorrimento.

*LED Huitre is an oval-shaped up & down wall lamp for interiors with integrated driver.*

*Source: high lumen SMD LED.*

*Body: in ADC12 aluminum which offers excellent thermal management.*

*Paint: Black RAL 9005.*

*Reflector: PC reflector can be customized in different colors (standard color is white).*

*An interchangeable CCT with slide switch is available.*

Outdoor

## LED Huitre W

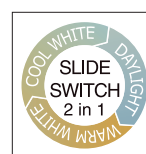
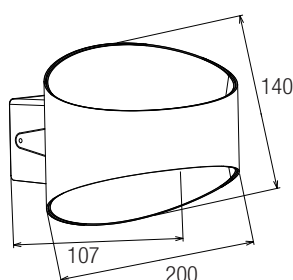

Funzione 2 CCT (3000K - 4000K) modificabile con interruttore a cursore  
*Slide switch 2 CCT (3000K - 4000K) changeable function*



Regolabile con dimmer a TRIAC  
*Dimmable with TRIAC dimmer*

colour	W	Optic	Lm	K	pcs	Kg	CELL	
<b>N</b>	8W	360°	425	3000	4000	1	0,52	RL95-8W-BL2P



# LED Rouget W

**NEW** 2023

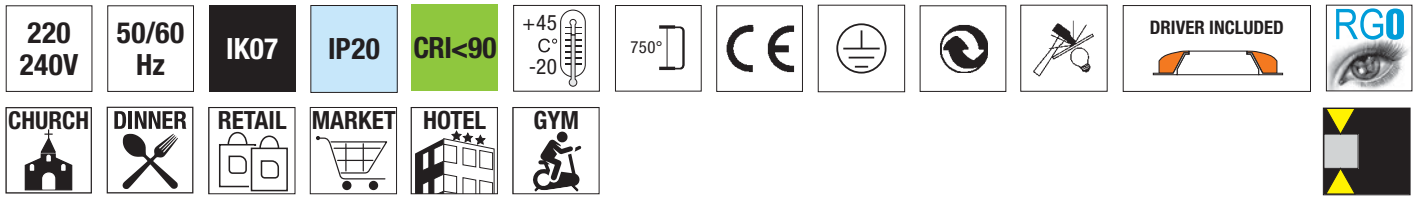

**Corpo lampada:** in alluminio ADC12. Ruotabile di 350° orizzontalmente  
**Cover:** in policarbonato. Ruotabile di 28° verticalmente  
**Verniciatura:** Bianco RAL 9016  
**Installazione:** a plafone o parete  
 Il design a basso UGR offre prestazioni di illuminazione soffusa.

**Lamp body:** in aluminum ADC12. 350 ° rotatable horizontally  
**Cover:** in polycarbonate. Can be rotated by 28 ° vertically  
**Paint:** White RAL 9016  
**Installation:** ceiling or wall  
 Low UGR design offers subdued lighting performance.



Outdoor

## LED Rouget W

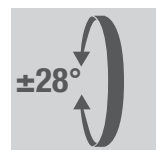
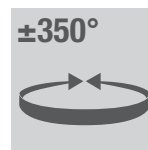
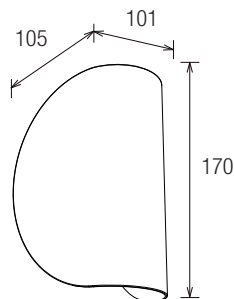

colour	W	Optic	Lm	K	pcs	Kg	CELL
B	2x4	90°	640	3000	1	0,68	RL101-8W-WH3K

# LED Primadonna S



Proiettori orientabili progettati per illuminare spazi commerciali (supermercati, grandi magazzini, retail, ecc.), uffici e qualsiasi ambiente dove è necessaria un'illuminazione generale e d'accento.

**Installazione:** a sospensione (completo di rosone di fissaggio).

**Corpo:** in alluminio pressofuso UNI 5076, verniciato con polvere termoisolante poliestere.

**Verniciatura:** di tipo poliestere eseguita a polvere. Colore nero RAL 9005 o Bianco RAL 9010.

**Ottica:** semi concentrante (a richiesta concentrante).

**Schermo:** vetro temperato di spessore 3mm.

**Driver:** incorporato.

**Conforme alla norma:** EN60598-1, RGO nessun rischio fotobiologico ai fini della norma EN62471.

**Led:** LUMILEDS - PHILIPS mantenimento del flusso luminoso minimo al 80%: 50.000h (L80B10).

*Series of adjustable projectors designed to light up retail spaces (supermarkets, department stores, shops, etc.), offices and any other place that requires general and spot lighting.*

**Installation:** for suspension (complete with ceiling rose).

**Body:** made by UNI 5076 die-cast aluminum, coated with polyester thermoset powder.

**Coating:** coated with powdered polyester. RAL 9005 black or RAL 9010 white color.

**Optic:** semi-clumping (clumping on demand).

**Shield:** tempered glass with 3mm thickness.

**Driver:** included.

**According to standard:** EN60598-1, RGO exempt from photo-biological risks in compliance with standard EN62471.

**Led:** LUMILEDS - PHILIPS maintenance of minimum luminous flux to 80%: 50.000h (L80B10).



220 240V	50/60 Hz	IK07	IP20	CRI<90	+40 C° -20	650°	CE				DRIVER INCLUDED	RG0
CHURCH	DINNER	RETAIL	MARKET	HOTEL	GYM	A richiesta: dimmerabile On demand: <i>dimmable</i>						

### LED Primadonna S

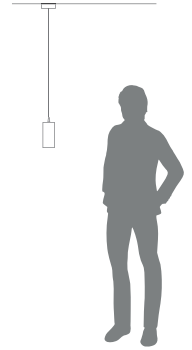
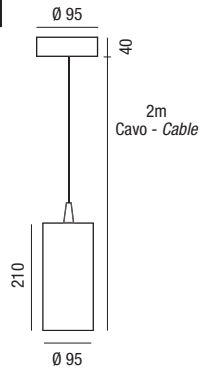

colour	W	lm output	K	△	△ on demand	pcs	Kg	CELL
B	30	3000	3000	40°	24°	001	1,44	32920/30/S
B	30	3000	4000	40°	24°	001	1,44	32920/30/S/4K
N	30	3000	3000	40°	24°	001	1,44	32922/30/S
N	30	3000	4000	40°	24°	001	1,44	32922/30/S/4K



### Accessori non inclusi - Not included accessories



#### Adattatore meccanico a 4 conduttori Electro-Mechanical 4 conductor adapter

Colour	A	pcs	Kg	Code
B	max 10Kg	010	0,05	9009-4/W
B	Nippel per sospensione			S-9009/BC-W

Suspended

# LED Belladigiorno S

Apparecchio singolo e fila continua  
Single devices and continuous line

A RICHIESTA  
ON DEMAND



Plafoniera a LED con ottica lenticolare quadrata per il massimo dell'efficienza con armatura di altezza 3 cm per utilizzo a sospensione, per aree comuni, uffici, reception, sale riunioni.

**Corpo:** in alluminio estruso con finitura anodizzata naturale, verniciato grigio RAL9006.

**Ottica:** parabola dark light in alluminio 99,85, antiriflesso UGR<10 e antiridescendente a bassissima luminanza, adatto per posti di lavoro a videoterminale.

**Conforme alla norma:** EN60598-1, RG0 nessun rischio fotobiologico ai fini della norma EN62471.

**LED:** Samsung Fattore di potenza  $\geq 0,95$  - mantenimento del flusso luminoso al 80%, 50.000h (L80B10) - Temperatura colore 4000K.

**Driver:** multipotenza . Fattore di potenza  $\geq 0,95$

Prodotto conforme alle direttive:

LED ceiling lamp with square lenticular optics for maximum efficiency with a 3 cm high fixture for suspended use, for common areas, offices, receptions, meeting rooms.

**Body:** in extruded aluminium with natural anodised finish, RAL 9006 gray painted.

**Optic:** 99.85 aluminium dark light parabola, antiglare UGR<10 and ant-iridescent, with low luminance, suitable for VDU workstations.

**According to standard:** EN60598-1, RG0 exempt from photo-biological risks in compliance with standard EN62471.

**LED:** Samsung  $\geq 0.95$  power factor - luminous flux maintenance at 80%, 50.000h (L80B10) - Colour temperature 4000K.

**Driver:** multipower. Power factor  $\geq 0.95$ .

Product compliant with directives:



## Versione standard:

l'apparecchio è dotato di doppia emissione integrata.

## Standard version:

the device is equipped with integrated double emission.

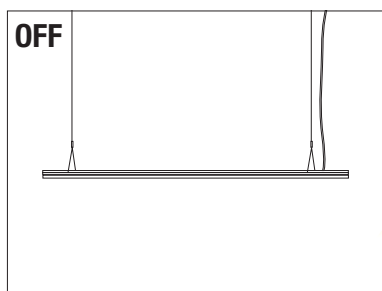
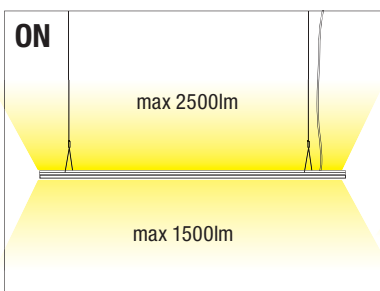

**A richiesta/On request:** accensione separata doppia emissione.

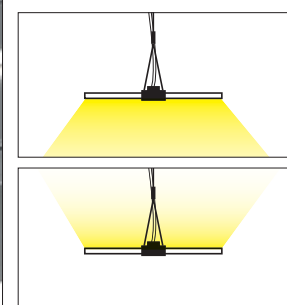

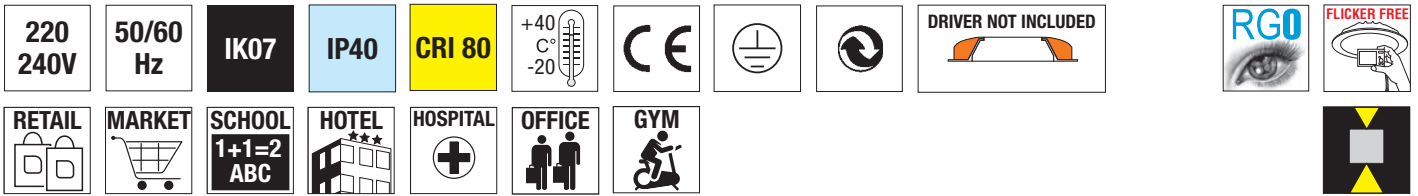

**LED Belladigiorno S**

**UGR <10**  
max 4000 lm

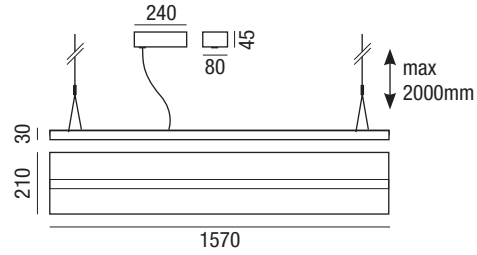
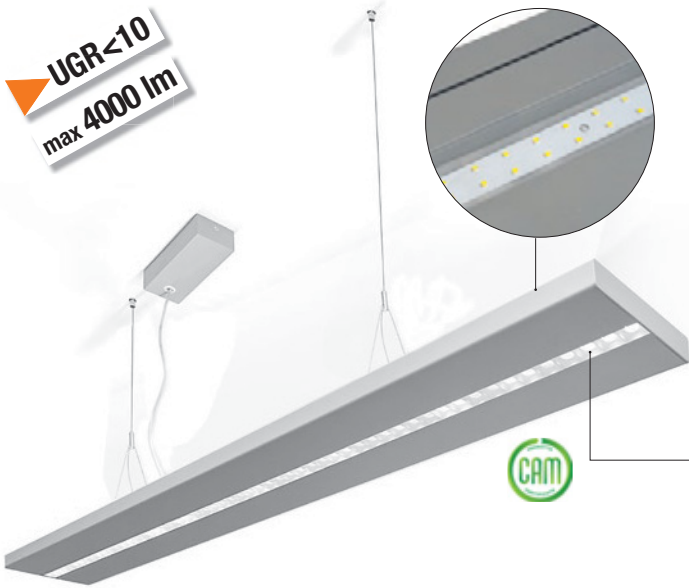

colour	W max	lm	Beam angle	K	pcs	Kg	S+L
G	40	↕ 2500 ↕ 1500	60°	4000	001	10,50	BDG-35/48/4K/B

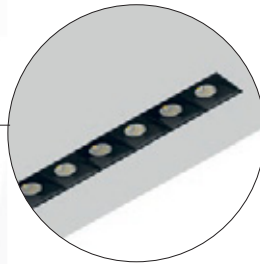

**Accessori inclusi - Included accessories**



**Sospensione con cavo a Y:** il cavo a Y garantisce il perfetto bilanciamento della lampada grazie alla frizione regolabile sui cavi.  
**Suspension with Y cable:** the Y-shaped cable guarantees perfect balance of the lamp thanks to the adjustable friction on the cables.



**Staffa di congiunzione:** da utilizzare per realizzare file continue.  
**Connecting bracket:** to use to make continuous rows.

**Dati fotometrici**  
**Photometric data**

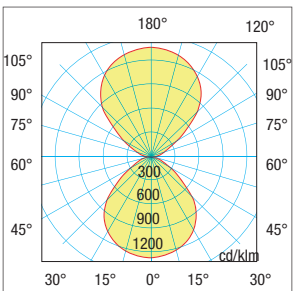

Applicazione sospesa in linea continua, con accensioni separate  
Suspension application continuous row, with with separate ignitions

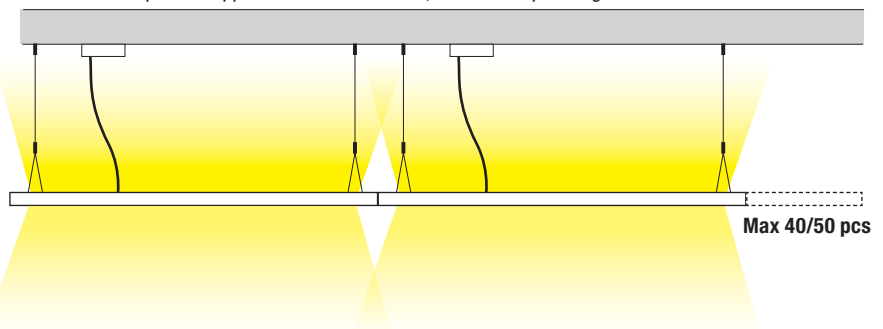

**Accessori non inclusi - Not included accessories**

**Tabella di scelta potenza driver LED - LED Power supply table choice**

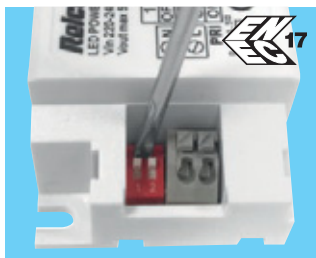

**LED driver multipower**  
**RN9164 ON-OFF**  
**RN9164-1-10V (0-10V)**  
**RN9168/DA (DALI, PUSH, 0-10V)**  
**RN9182DAPU (DALI2 PUSH)**

**Fornito di dip switch per la selezione della corrente in uscita.** Il driver incluso nella confezione è normalmente settato a 40W (vedi tabella). Se necessario è possibile diminuire la potenza e di conseguenza i lumen output.  
**Equipped with dip switch for selecting the current output.** The driver included inside the package is usually set to 40W (see table). If necessary it is possible to decrease the power and consequently the lumen output.

Taratura Dip-switch	Potenza Power	Lm Output
mA	Watt	Lm
800	30	3000
1050	40	4000

Taratura standard di fabbrica  
Driver Standard factory setting

Suspended

## LED Zante Top S

Apparecchio LED a sospensione ad emissione diretta e indiretta neutral white 4000K ad alta resa cromatica, per aree comuni, uffici, corridoi, strutture sanitarie, sale riunioni, negozi. Per ambienti dove sia necessaria una luce diffusa perfettamente omogenea. Ideale per spazi di lavoro in cui è necessario un maggiore controllo dell'abbagliamento, grazie allo schermo diffusore microprismato, abbinato ad uno schermo interno e ad un film diffondente, consente un'ottimale diffusione della componente diretta della luce e un controllo della luminanza UGR<19. I led per l'emissione down light e up light sono disposti nel perimetro.

**Installazione:** a sospensione. Il sistema è completo di basetta di alimentazione e cavi lunghezza 2000 mm.

**Corpo e telaio:** profilo perimetrale in alluminio estruso anodizzato, verniciati con polvere termoindurente poliestere.

**Verniciatura:** di tipo poliestere eseguita a polvere. Colore bianco RAL 9010.

**Ottica:** diffondente. Composta da lastra in tecnopolimero (PMMA).

**Schermo:** schermo diffusore microprismato.

**UGR:** Conforme alla norma EN 12464-1 -  $\leq 19$ .

**Temperatura colore:** standard 4000K.

**Conforme alla norma:** EN60598-1, RG0 nessun rischio fotobiologico ai fini della norma EN62471.

**Led:** mantenimento del flusso luminoso minimo al 80%: 50.000h (L80B10).

**Driver:** Fattore di potenza  $\geq 0,95$ .

*Suspension LED device with direct and indirect emission, neutral white 4000K with high colour rendering, for public areas, offices, halls, healthcare facilities, meeting rooms, shops. For environments requiring a perfectly evenly diffused light. Ideal for workspaces which need greater glare control, thanks to the microprismatic diffuser screen, coupled to an internal diffusing film screen, for optimal diffusion of the direct light component and luminance control UGR<19. LEDs for down light and up light emission are set up in the perimeter.*

**Installation:** suspension. The system includes power baseboard and 2000 mm long cables.

**Body and frame:** perimeter profile in anodised extruded aluminium, coated with thermosetting polyester powder.

**Painting:** powder polyester coating. White RAL 9010.

**Optics:** diffusing. Consisting of techno-polymer sheet (PMMA).

**Screen:** microprismatic diffuser screen.

**UGR:** Complies with standard EN 12464-1 -  $\leq 19$ .

**Colour temperature:** standard 4000K.

**Compliant with standard:** EN60598-1, RG0 no photobiological risk for the purposes mentioned in standard EN62471.

**LED:** maintenance of 80% minimum luminous flux: 50,000h (L80B10).

**Driver:** Power factor  $\geq 0.95$ .

► UGR<19



220 240V	50/60 Hz	IK07	IP20	CRI 80	+40 C -20	65°	CE			DRIVER INCLUDED	RG0	
RETAIL	MARKET	SCHOOL 1+1=2 ABC	HOTEL	HOSPITAL	OFFICE	GYM	COOL WHITE SLIDE SWITCH 2 in 1 CLASSIC WARM	Funzione 2 CCT (3000K - 4000K) modificabile con interruttore a cursore. Slide switch 3 CCT (3000K - 4000K) changeable function.			UGR ≤19	

### LED Zante Top

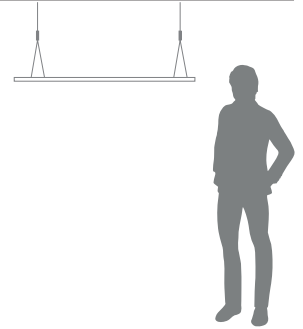
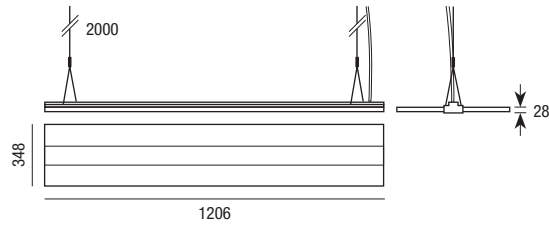
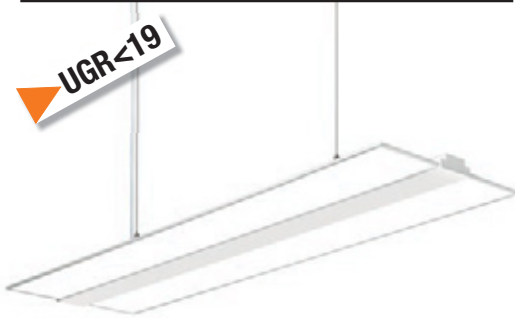

colour	W max	Lm output	lm/W	K	pcs	Kg	CELL
[B]	45	max 4700	105	3000 4000	001	2,70	25930/S/TOP

**A richiesta:** versione 3000K e 6000K (consegna 90gg.)  
**On demand:** 3000K and 6000K versions (delivery 90 days)

### Dati fotometrici Photometric data

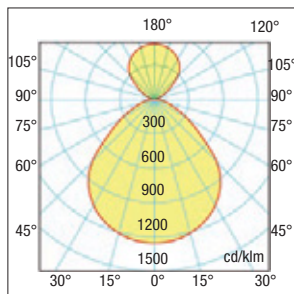

**Versione standard:**  
l'apparecchio è predisposto per l'accensione contemporanea di entrambe le emissioni luminose.  
**Standard version:**  
The device is designed for both luminous emissions to switch on simultaneously.

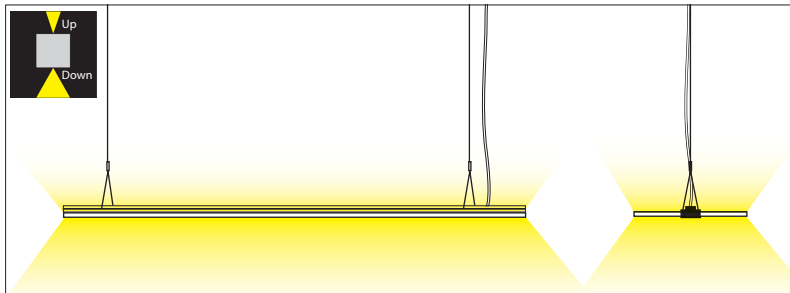

**Sospensione con cavo a Y:**  
il cavo a Y garantisce il perfetto bilanciamento della lampada.  
**Suspension with Y cable:**  
the Y cable guarantees perfect balancing of the lamp.



Suspended

# LED Luxxi

A RICHIESTA  
ON DEMAND

0-10V

DALI 2



Serie di proiettori a sospensione con elevata resa cromatica per utilizzo in centri commerciali, supermercati per mettere in risalto i banchi di alimentari, uffici o spazi in coworking, concessionari e grandi aree in genere.

**Corpo:** vano porta componenti in alluminio pressofuso, verniciato a polveri poliestere resistente alla corrosione ed agli agenti atmosferici. Dissipatore in lega di alluminio estruso. Piastra porta cablaggio in acciaio.

**Diffusore:** in policarbonato trasparente internamente prismaticizzato e all'esterno liscio antipolvere per una rapida pulizia, infrangibile e autoestinguente V2.

**Conforme alla norma:** EN60598-1, RG0 nessun rischio fotobiologico ai fini della norma EN62471.

**Led:** mantenimento del flusso luminoso minimo al 80%: 50.000h (L80B10).

**Driver:** Incluso > 50.000 h Fattore di potenza ≥0,95.

*Series of suspended projectors with high colour rendering for use in shopping centres, supermarkets to highlight food counters, offices or co-working spaces, dealerships and large areas in general.*

**Body:** component holding body in die-cast aluminium with polyester-powder against corrosion and weathering. Dissipator in extruded aluminium alloy. Steel wiring plate.

**Diffuser:** in transparent polycarbonate internally prismaticized and smooth dust-proof on the outside for quick cleaning, unbreakable and self-extinguishing V2.

**Compliant with standard:** EN60598-1, RG0 no photobiological risk for the purposes mentioned in standard EN62471.

**LED:** maintenance of 80% minimum luminous flux: 50,000h (L80B10).

**Driver:** Included > 50,000 h Power factor ≥0.95.



Vedi anche LED Minizeus pag.26  
See also LED Minizeus page 26

220 240V	50/60 Hz	IK08	IP43	CRI 90	+40 C -20	850°	CE				DRIVER INCLUDED	RG0



## LED Luxxi 500

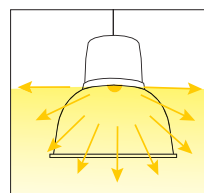
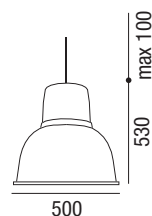

colour	W		Lm output	K	pcs	Kg	CELL
N	40	60°	4600	3000	001	6.50	28161/40W
N	40	60°	4600	4000	001	6.50	28161/4K/40W
N	60	60°	6900	3000	001	6.50	28161/60W
N	60	60°	6900	4000	001	6.50	28161/4K/60W



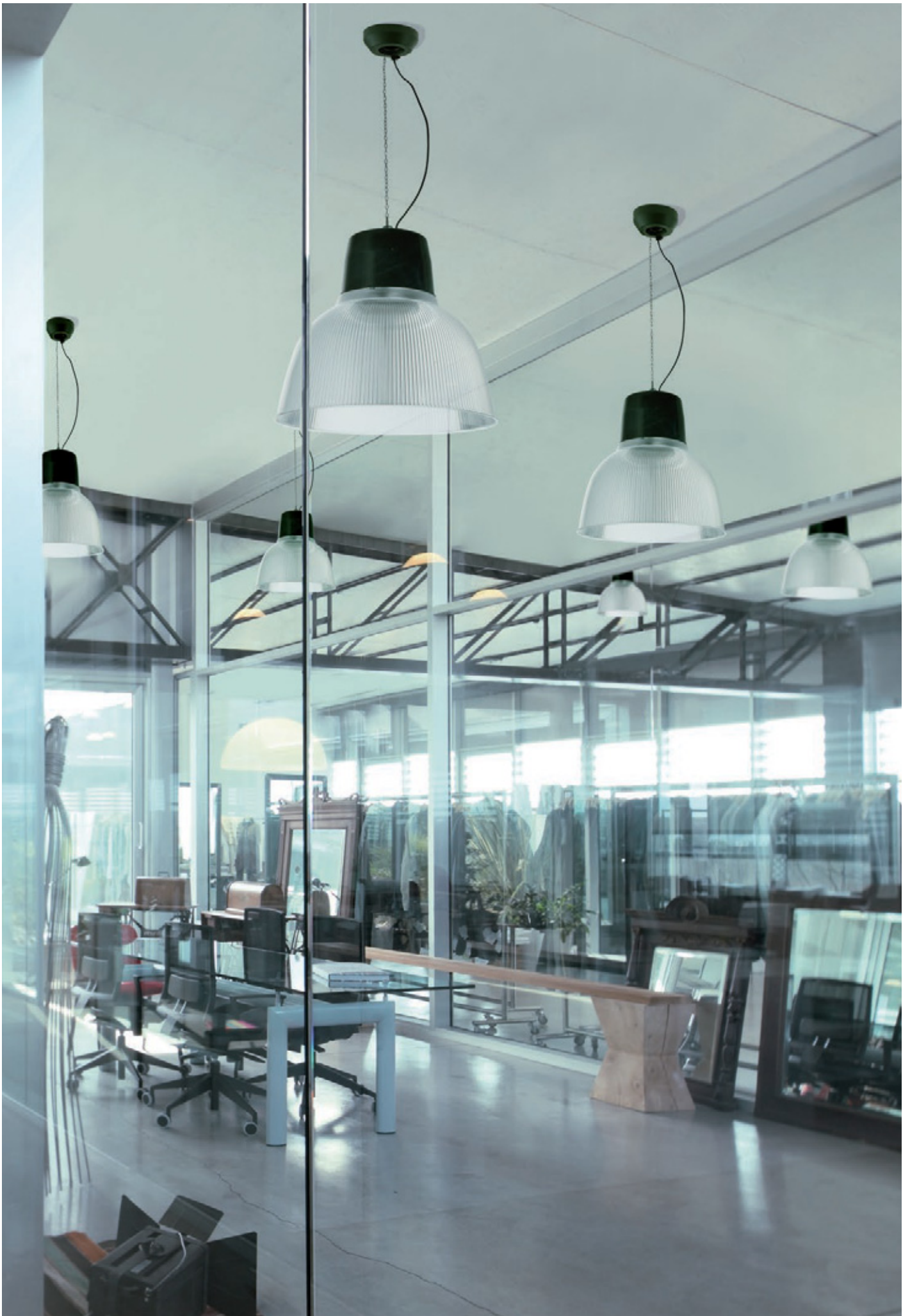

Suspended

## Estensione LED

A RICHIESTA  
ON DEMAND

WIRELESS

0-10V

DALI 2

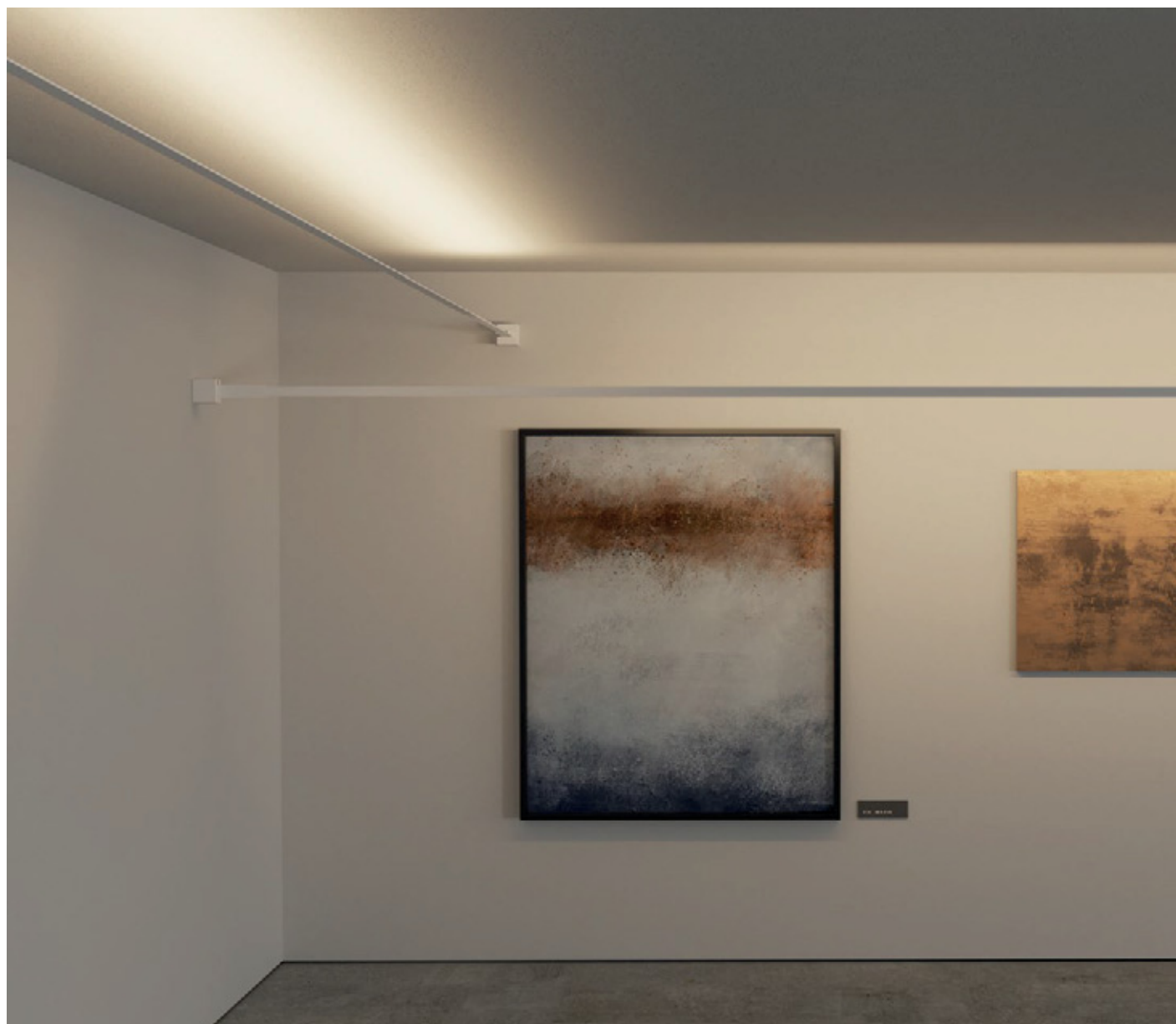
**Estensione LED.**

Estensione LED è un novo modo di pensare la luce: grazie alla sua flessibilità è facilmente trasportabile e tagliabile su misura, può essere montato a parete, a soffitto o da parete a soffitto.

**È un sistema in bassa tensione sviluppato sia per l'illuminazione diretta che indiretta degli ambienti.**

**Installazione:** Gli attacchi, con sistema a perno interno, rendono possibile la rotazione orizzontale a 180° del cavo, possibilità di combinare strip led e faretto Mlni LED. Infinite posizioni per infiniti utilizzi  
**Corpo:** realizzato in materiale plastico isolante. Integra, internamente, due cavi tenditori in acciaio che permettono di realizzare tesate fino a 10m di lunghezza. Bianco RAL 9010 e nero RAL 9005.

**Conforme alla norma:** 60598-2-23

**Led:** strip led 24V Flex cob; 3000K - 4000K.

strip led 24V Flex Bianco dinamico 2700>6500K.

**Driver:** Alimentatore 24V a 60W, 120W e 200W.

**Controller:** KZQ-3 per la dimmerazione della luce.

**Led:** Spot led 48V; 3000K - 4000K.

**Driver:** Alimentatore 48V a 70W, e 150W.

**Controller:** KZQ-3 per la dimmerazione della luce.

**Estensione LED.**

*Extension LED is a new way of thinking about light: thanks to its flexibility it is easily transportable and cut to size, it can be mounted on the wall, ceiling or wall-to-ceiling.*

***It is a low tension system developed for both direct and indirect lighting of environments.***

**Installation:** The connections, with internal pin system, make it possible to rotate the cable horizontally by 180°, possibility of combining LED strips and Mlni LED spotlights. Infinite positions for infinite uses

**Body:** made of insulating plastic material. It integrates, internally, two steel tension cables that allow for the creation of stretches up to 10m in length. White RAL 9010 and black RAL 9005.

Compliant with standard: 60598-2-23

**Led:** 24V Flex Cob led strip; 3000K - 4000K.

24V Flex monochromatic led strip Tunable white 6500K.

**Driver:** 24V 60W, 120W and 200W.

**Controller:** KZQ-3 controller for light dimming.

**Led:** Spot led 48V; 3000K - 4000K.

**Driver:** 48V power supply at 70W and 150W.

**Controller:** KZQ-3 controller for light dimming.

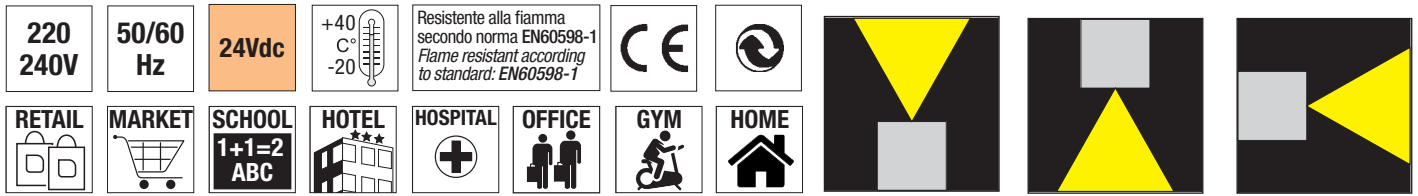

Estensione LED è indicato per l'illuminazione indiretta, diretta e l'illuminazione laterale.

*Estensione LED is suitable for indirect lighting, direct lighting and lateral lighting.*

Il cavo, realizzato in materiale termosplastico isolante, è disponibile in due differenti finiture: nero e bianco. Viene fornito maggiorato di 50 cm per agevolare la fase di installazione.

*The cable, made of insulating thermoplastic material, is available in two different finishes: black and white. It is supplied increased by 50 cm to facilitate the installation phase.*

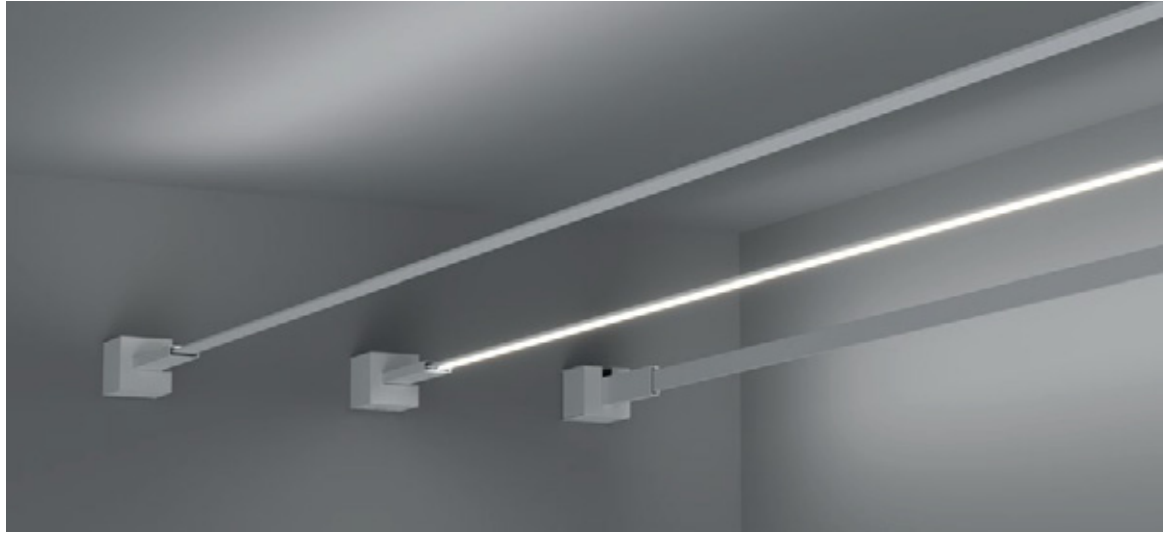

Estensione LED può essere montato a parete, a soffitto o da parete a soffitto. Gli attacchi, con sistema a perno interno, rendono possibile la rotazione orizzontale a 180° del cavo. Infinite posizioni per infiniti utilizzi. Gli attacchi includono i tenditori. La massima lunghezza consentita dell'installazione è di 10m.

*Estensione LED can be mounted on the wall, ceiling or wall to ceiling. The connections, with an internal pin system, make it possible to rotate the cable horizontally through 180°. Infinite positions for infinite uses. The bindings include the turnbuckles. The maximum permissible length of the installation is 10m.*



# Estensione LED, system

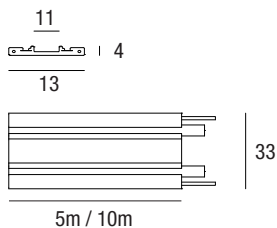

## Cavo - Cable

Colour	L. mm	pcs	Kg	Code
B	5000	001	1	R-40301
B	10000	001	2	R-40302
N	5000	001	1	R-40501
N	10000	001	2	R-40502

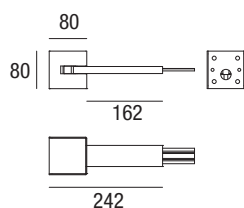
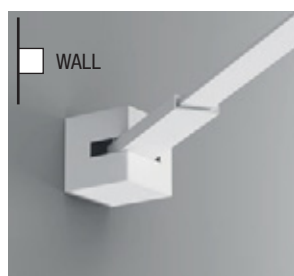
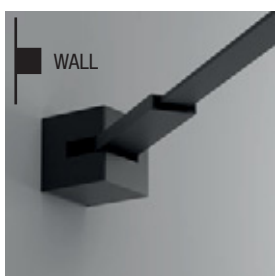

## Attacco parete - Wall fixing

Colour	pcs	Kg	Code
B	001	1,30	R-40303
N	001	1,30	R-40503

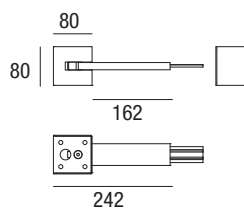
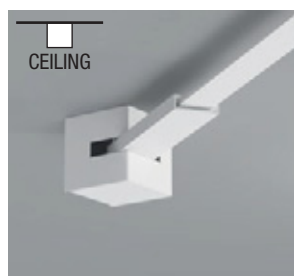
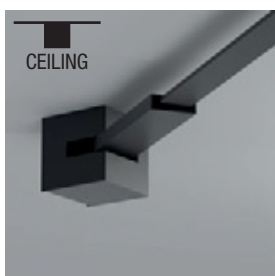

## Attacco soffitto - Ceiling fixing

Colour	pcs	Kg	Code
B	001	1,30	R-40304
N	001	1,30	R-40504

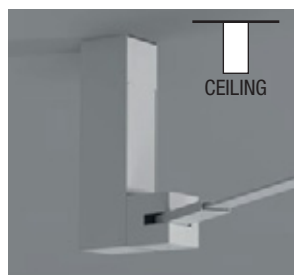
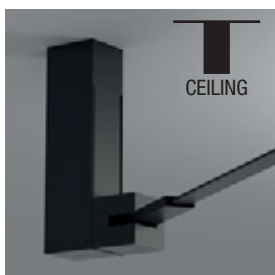

## Distanziatore soffitto (da abbinare ad attacco parete) Ceiling spacer (to be combined with wall connection)

Colour	pcs	Kg	Code
B	001	3	R-40305
N	001	3	R-40505



## Cavo di sostegno regolabile - Wire support adjustable

Colour	pcs	Kg	Code
B	001	0,20	R-40313
N	001	0,20	R-40513

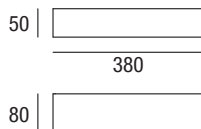

## Scatola per alimentatore - Box driver

Colour	pcs	Kg	Code
B	001	0,95	R-40318
N	001	0,95	R-40518

# Estensione LED

strip led consigliate  
*strip led, recommended*

LED Flex COB monocromatiche - 24V  
LED Flex COB monochromatic - 24V

100 lm/W m

3000K cod. 30904/COB  
4000K cod. 30904/COB/4K



Per dati tecnici Strip Led, scelta dei Driver diversi da quelli consigliati e info tecniche, For Strip Led technical data, choice of Drivers other than the recommended ones and technical info.

vedi pag.  
see page  
**424-431**



LED Flex bianco dinamico - 24V  
LED Flex Tunable white - 24V

100 lm/W m

2700>6500K cod. 30937/TW

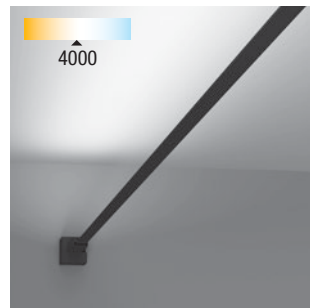

Estensione LED permette di utilizzare Strip LED Tunable white che abbinata al controller KZQ-3 danno la possibilità di scegliere la temperatura colore desiderata, bianco caldo (2700K), bianco neutro (4000K) o bianco freddo (6500K).

LED extension allows you to use Tunable white LED Strips which combined with the KZQ-3 controller give the possibility to choose the desired color temperature, warm white (2700K), neutral white (4000K) or cold white (6500K).



# Micro LED

spot orientabile per Estensione LED System  
adjustable spot for Estensione LED System

220 240V	50/60 Hz	48Vdc	IK06	IP20	CRI 97	+40 C° -20	650°	RG0	CE	III	DRIVER NOT INCLUDED MULTIPOWER
RETAIL	MARKET	SCHOOL 1+1=2 ABC	HOTEL	HOSPITAL	OFFICE UGR<16	GYM	HOME				

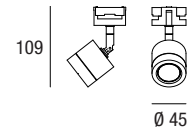

Colour	W max	V.	lm output max	K	Kg	S+L
B	9	48	728	3000	0,1	R-42331
B	9	48	770	4000	0,1	R-42332
N	9	48	728	3000	0,1	R-42531
N	9	48	770	4000	0,1	R-42532



È possibile combinare il faretto con la striscia LED desiderata, per un massimo di 14 sorgenti Micro LED Spot (Driver 150W) per tesata, inoltre è possibile la dimmerazione tramite il controller LED KZQ-3.

It is possible to combine the spotlight with the desired LED strip, for up to 14 Micro LED Spot (Driver 150W) sources per header, and dimming via the KZQ-3 LED controller is also possible.

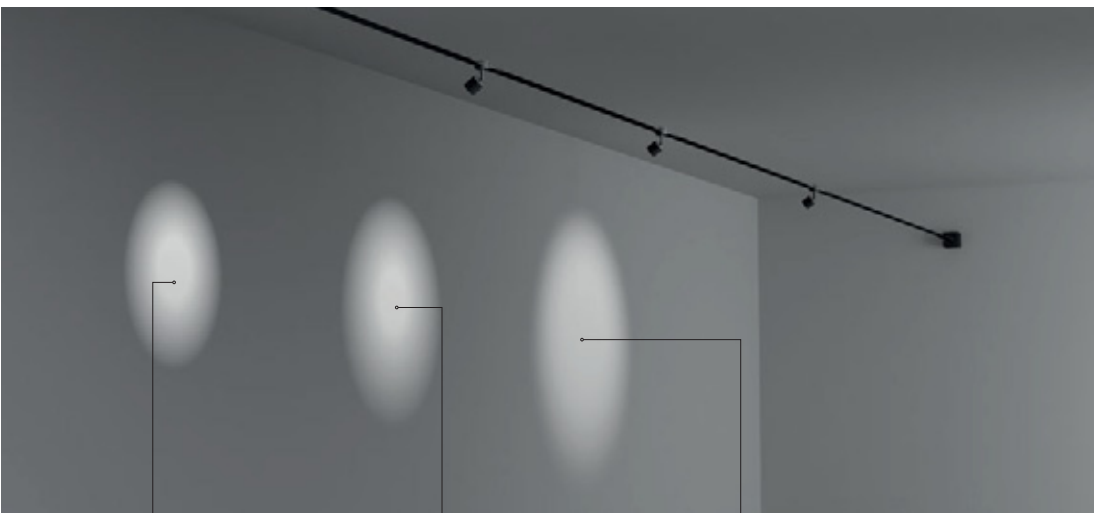

Driver 48V. (non incluso)  
Driver 48V.(not included)



W max	Vdc	LxHxP mm.	Code
150	48	240x49x60	122764

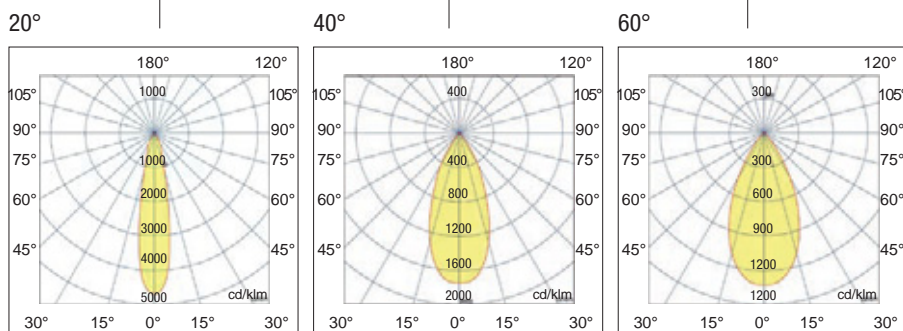

Lente (non inclusa) - Lens (not included)

Code
20° R-40102
40° R-40103
60° R-40104

A seconda della necessità è possibile scegliere la lente come accessorio non incluso.

Depending on the need, it is possible to choose the lens as an accessory not included.

Cable Light



## driver e controller consigliati driver and controller recommended

Controller per strisce LED e Spot Micro LED  
Controller for *strip LED* and *Spot Micro LED*

**KZQ-3**  
Cod. 30948



vedi pag.  
see page  
**436**

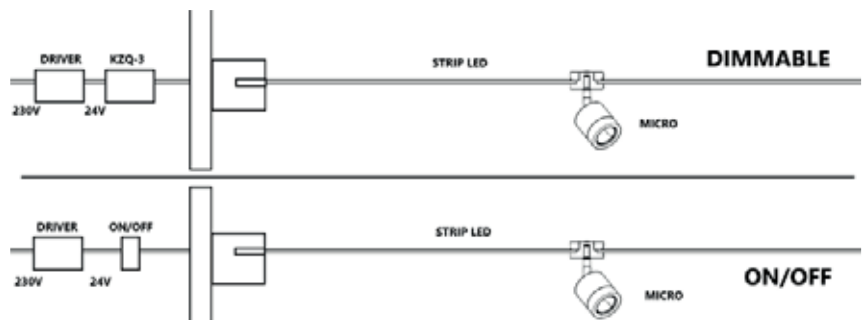

Esempio di installazione dimmerabile con KZQ-3 Codice 30948 (Push button DIM / 0-10V DIM / DALI DIM) o installazione non dimmerabile. La Strip LED e gli spot MICRO possono essere alimentati insieme (accensione unica) oppure possono essere alimentati separatamente attraverso l'utilizzo di due alimentatori (doppia accensione).

*Example of dimmable installation with KZQ-3 Code 30948 (Push button DIM / 0-10V DIM / DALI DIM) or non-dimmable installation. The LED Strip and the MICRO spots can be powered together (single switch) or they can be powered separately through the use of two power supplies (double switch).*

### Driver 24V.

**MINILED 24-60W**  
Cod. RN1428  
Cod. RN1279 **DALI**



**DRIVER**  
24Vdc

**MINILED 24-120W**  
Cod. RN9175/24  
Cod. 1279/100 **DALI**



**DRIVER**  
24Vdc

**MINILED 24-200W**  
Cod. RN9175/24/200  
Cod. RN1227 (150W) **DALI**



**DRIVER**  
24Vdc

# LED Flex

## LED Flex Monocromatica

Strisce flessibili per interni e per esterni anche in IP20, IP65 o IP67, con led a luce bianca (calda 3000K, neutra 4000K o fredda 6000K).

La versatilità di queste strisce le rende utili in molte applicazioni come ad esempio per disegnare con la luce l'architettura degli edifici, per la retro-illuminazione di espositori o insegne, per banconi o nicchie di negozi, ristoranti, bar, cinema e per effetti scenografici nelle abitazioni.

Le strisce led sono facili da installare, consumano pochissima energia elettrica, durano oltre 20.000 ore e non richiedono manutenzioni.

**Installazione:** tramite ganci in materiale termoplastico (inclusi) o tramite incollaggio.

**Corpo:** materiale termoplastico

**Alimentazione:** 12V o 24V non inclusa (pag.294-295).

*Flexible LED strips for indoor or outdoor use. Available in IP20, IP65 or IP67 with white (warm 3000K, neutral 4000K or cool 6000K) LEDs.*

*The versatility of these strips means they can be used for various applications: highlighting special architectural features, display stand/sign backlighting, lighting counters/alcoves in shops, restaurants, bars and cinemas and for scenic effects at home.*

*The LED strips are easy to install, consume very little energy, last for over 20.000 hours and do not need any maintenance.*

**Installation:** using thermoplastic hooks (included) or an adhesive.

**Body:** thermoplastic material

**Power supply:** 12V or 24V not included (page 294-295).

## LED Flex COB

Strisce LED continue flessibili per interni e per esterni in IP20 o IP67, con LED COB a luce bianca (calda 3000K, neutra 4000K).

La versatilità di queste strisce le rende utili in molte applicazioni come ad esempio per disegnare con la luce l'architettura degli edifici, per la retro-illuminazione di espositori o insegne, per banconi o nicchie di negozi, ristoranti, bar, cinema e per effetti scenografici nelle abitazioni.

Le strisce led sono facili da installare, consumano pochissima energia elettrica, durano oltre 20.000 ore e non richiedono manutenzioni.

**Installazione:** tramite ganci in materiale termoplastico (inclusi) o tramite incollaggio.

**Corpo:** materiale termoplastico

**Alimentazione:** 24V non inclusa (pag.295).

*Continue and flexible LED COB strips for indoor or outdoor use. Available in IP20 or IP67 with white (warm 3000K, neutral 4000K) LEDs COB.*

*The versatility of these strips means they can be used for various applications: highlighting special architectural features, display stand/sign backlighting, lighting counters/alcoves in shops, restaurants, bars and cinemas and for scenic effects at home.*

*The LED strips are easy to install, consume very little energy, last for over 20.000 hours and do not need any maintenance.*

**Installation:** using thermoplastic hooks (included) or an adhesive.

**Body:** thermoplastic material

**Power supply:** 24V not included (page 295).

## LED Flex Tunable white

Strisce flessibili Tunable White con regolazione variabile della temperatura di colore, agendo su un pulsante NA la temperatura colore passa dalla tonalità calda a quella fredda, creano un ambiente capace di sostenere le persone in modo naturale, al pari di quanto fa la luce diurna, per interni e per esterni in IP20 o IP67, con led a luce variabile bianca calda 3000K, neutra 4000K o fredda 6000K. La versatilità di queste strisce le rende utili in molte applicazioni come ad esempio per disegnare con la luce l'architettura degli edifici, per la retro-illuminazione di espositori o insegne, per banconi o nicchie di negozi, ristoranti, bar, e per creare ambienti diversi durante la giornata ricreando la luce esterna, ottima per gli spazi chiusi laddove si necessiti ricreare scenari naturali e aiutare la concentrazione come uffici e aule didattiche.

**Installazione:** tramite ganci in materiale termoplastico (inclusi) o in profili in alluminio dissipanti (pag. 256).

**Corpo:** materiale termoplastico

**Alimentazione:** 12V o 24V non inclusa (pag.294-295).

La striscia può essere collegata insieme ad altre per ottenere file continue di luce (max 10m).

*Flexible Tunable White strips with variable colour temperature adjustment, acting on an NA push button, the colour temperature changes from warm to cold, creating an environment that can support people in a natural way, just like daylight, for indoors and outdoors in IP20 or IP67, with variable warm white light LEDs 3000K, neutral 4000K or cold 6000K. The versatility of these strips makes them useful in many applications, such as to design the architecture of buildings with light, for the backlighting of displays or signs, for counters or niches of shops, restaurants, bars, and to create different environments during the day, recreating the outdoor light, excellent for enclosed spaces where natural scenarios need to be recreated, and help concentration, such as in offices and classrooms.*

**Installation:** using hooks in thermoplastic material (included) or inside dissipating aluminium profiles (page 256).

**Body:** thermoplastic material.

**Power supply:** 12V or 24V not included (page 294-295).

*The strip can be connected together with others to obtain continuous rows of lights (max 10m).*

## LED Flex RGB

Strisce flessibili per interni e per esterni in IP67 con led RGB fullcolor in grado di emettere luce di tutti i colori grazie dalla miscelazione dei tre colori base Rosso, Verde e Blu.

**Installazione:** tramite ganci in materiale termoplastico (inclusi) o tramite adesivo presente sulla superficie posteriore.

**Applicazioni:**

- Per soluzioni di illuminazione color-changing in strutture lineari e forme libere.

- Per iniettare la luce in materiali trasparenti o disperdenti.

- Illuminazione architettonica d'effetto.

- Effetti dinamici nelle aree pubbliche.

**Corpo:** materiale termoplastico

**Alimentazione:** 12V o 24V non inclusa (pag.294-295), KZQ3 (pag. 296).

La striscia può essere collegata insieme ad altre per ottenere file continue di luce (max 10m).

*IP67 indoor and outdoor flexible strips with RGB LED that is able to emit light of all colours by mixing three Red, Green, Blue base colours.*

**Installation:** with thermoplastic material hooks (included) or with the adhesive tape placed on the back.

**Application:**

- Colour change lighting in linear/free-form architecture structures.

- Injecting light through transparent or light-dispersing materials.

- Highlighting special architectural features.

- Dynamic public lighting.

**Body:** thermoplastic material.

**Power supply:** 12V or 24V not included (page 251-252-253), KZQ3 (pag. 296).

*The strips can be connected to each others for continuous lighting effect. (max 10m).*

## Per tutti i codici - For all codes

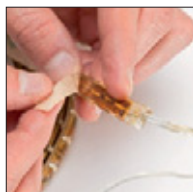

### Per tutti i codici - For all codes

Strisce a LED applicabili su superfici lisce, pulite ed asciutte con adesivo 3M.

*LED strips applicable to smooth, clean and dry surfaces with 3M adhesive.*

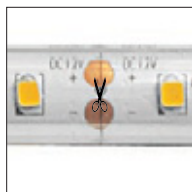

Effettuare il taglio in corrispondenza del simbolo della forbice e la linea tratteggiata.

*Make the cut in correspondence of the scissor symbol and dotted line.*

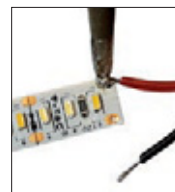

In caso sia necessario saldare dei nuovi cavi utilizzarli prestagnati e delle sezioni opportune; filo di stagno senza piombo con flussante no clean.

*If it is necessary to weld eventual new cables, just use pre-solder and appropriate section cables, lead-free tin wire, with no-clean fluxing.*

**ATTENZIONE:** Per le strisce LED in IP20 >4,8W/m e IP67 >15W/m deve essere applicato su un estruso in alluminio o su un opportuno dissipatore che ne permetta l'impiego in un regime di temperatura consono. In particolare la temperatura misurata sul circuito stampato non deve superare i 50°. Ogni applicazione che esuli dal presente accorgimento può compromettere la funzionalità, nonché la vita del prodotto. Relco dispone di estrusi in alluminio o dissipatori in varie dimensioni, in modo da poter esaudire il maggior numero di richieste.

**ATTENTION:** To the LED strips (> 4,8W/m) has to be applied on an aluminium profile or an special heat sink in order to guarantee the product to work properly under controlled temperature. In particular the measured temperature on the pcb must not exceed 50°C. Any other type of application that doesn't follow the previous specs could damage the function and the life of the LED Strip. Relco has aluminum extruded profiles or heat sinks in different dimensions, in order to carry out the greatest number of requests (See Pag. 297).





# LED Flex monocromatica 12Vdc IP20 - IP67

LED Flex monocromatica 12V.



**CRI 90** **IP20**

colour	W/m	Led/mt*	Pitch	K	Lm/m	Efficiency	pcs	Kg	Width mm.	S+L
T	4,8	30	100	3000	480	100	1	0,36	10	30937
T	9,6	60	50	3000	960	100	1	0,36	10	30904/ECO
T	9,6	60	50	4000	960	100	1	0,36	10	90.011/010
T	14,4	78	38.46	3000	1440	100	1	0,36	10	40904
T	19,2	120	25	3000	1920	100	1	0,36	10	30904
T	19,2	120	25	4000	1920	100	1	0,36	10	90.012/010



**CRI 90** **IP67**

colour	W/m	Led/mt*	Pitch	K	Lm/m	Efficiency	pcs	Kg	Width mm.	S+L
T	4,8	30	100	3000	480	100	1	0,36	10	90.001/012
T	9,6	60	50	3000	960	100	1	0,36	10	90.011/012
T	9,6	60	50	4000	960	100	1	0,36	10	90.011/011
T	14,4	78	38.46	3000	1440	100	1	0,36	10	40904/IP67
T	19,2	120	25	3000	1920	100	1	0,36	10	90.001/012PLUS
T	19,2	120	25	4000	1920	100	1	0,36	10	90.001/011PLUS

A richiesta con consegna a 90 giorni, color 2200K - 2700K - 5000K e 6500K.  
On request with delivery in 90 days, color 2200K - 2700K - 5000K and 6500K.

Le misure di cui sopra possono avere una tolleranza del 10%.  
The above measurements can have a 10% tolerance

\*Quantità dei LED per metro lineare  
Quantity of LEDs per linear metre

## Dati fotometrici Photometric data

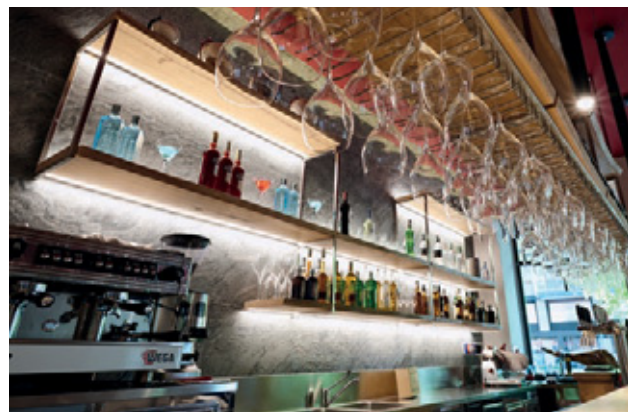
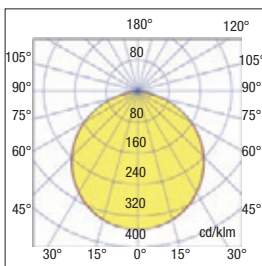

## Accessori inclusi - Included accessories



**Per codici IP20**  
**For IP20 codes**  
Cavi di connessione al driver  
Connection cables to the driver

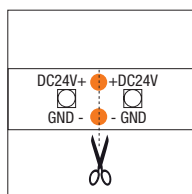

Effettuare il taglio in corrispondenza del simbolo della forbice e la linea tratteggiata.  
Make the cut in correspondence of the scissor symbol and dotted line.



**Per codici IP67**  
**For IP67 code**

La confezione contiene, clip di fissaggio, tappi di chiusura, cavi di collegamento IP ad alimentatore, tubo silicone per ripristino IP, connessioni iniziale e finale strip e per collegamento in serie. Le strip possono essere sezionate ad interassi prefissati; in caso di tagli intermedi utilizzare i tappi inclusi ed assicurarsi di sigillare accuratamente le estremità tagliate.

The package contains fixing clips, closure caps, IP connection cables to power supply, silicone hose for IP reset, initial and final strip connections and connection in series.

The strips can be sectioned at preset intervals; in the case of intermediate cuts, use the included caps and make sure to carefully seal the cut ends



Connettore per linea continua.  
Connector for continuous line.

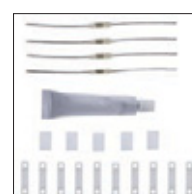

# LED Flex monocromatica 24 Vdc IP20 - IP67

## LED Flex monocromatica 24V.



A richiesta con consegna a 90 giorni, color 2200K - 2700K - 5000K e 6500K.  
On request with delivery in 90 days, color 2200K - 2700K - 5000K and 6500K.

### Dati fotometrici Photometric data

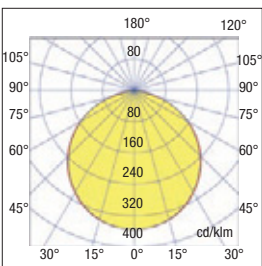

### Accessori inclusi - Included accessories



**Per codici IP20**  
**For IP20 codes**  
Cavi di connessione al driver  
Connection cables to the driver



Connettore per linea continua.  
Connector for continuous line.

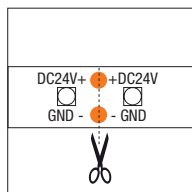

Effettuare il taglio in corrispondenza del simbolo della forbice e la linea tratteggiata.  
Make the cut in correspondence of the scissor symbol and dotted line.



**Per codici IP67**  
**For IP67 code**

La confezione contiene, clip di fissaggio, tappi di chiusura, cavi di collegamento IP ad alimentatore, tubo silicone per ripristino IP, connessioni iniziale e finale strip e per collegamento in serie. Le strip possono essere sezionate ad intervalli prefissati; in caso di tagli intermedi utilizzare i tappi inclusi ed assicurarsi di sigillare accuratamente le estremità tagliate.

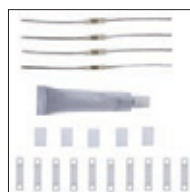

The package contains fixing clips, closure caps, IP connection cables to power supply, silicone hose for IP reset, initial and final strip connections and connection in series.

The strips can be sectioned at preset intervals; in the case of intermediate cuts, use the included caps and make sure to carefully seal the cut ends



CRI 90

IP20

colour	W/m	Led/mt*	Pitch	K	Lm/m	Efficiency	pcs	Kg	Width mm.	S+L	
T	4,8	30	166.67	3000	480	100	1	0,36	10	30937/24	
T	9,6	60	100	3000	960	100	1	0,20	10	30904/ECO/24	
T	9,6	60	100	4000	960	100	1	0,20	10	90.011/010/24	
T	14,4	78	76.92	3000	1440	100	1	0,36	10	40904/24	
NEW	T	16	210	33.33	2700	1552	97	1	0,36	8	RB210208-27
NEW	T	16	210	33.33	3000	1600	100	1	0,36	8	RB210208-30
T	19,2	120	50	3000	1920	100	1	0,20	10	30904/24/PLUS	
T	19,2	120	50	4000	1920	100	1	0,20	10	30670/24/PLUS	
NEW	T	22,4	224	35.71	3000	3136	140	1	0,20	10	R224210-30
NEW	T	22,4	224	35.71	4000	3584	160	1	0,20	10	R224210-40
T	24	300		3000	2400	100	1	0,20	10	90.001/012/24	

CRI 90

IP67

colour	W/m	Led/mt*	Pitch	K	Lm/m	Efficiency	pcs	Kg	Width mm.	S+L	
T	4,8	30	166.67	3000	480	100	1	0,36	10	90.001/024	
T	9,6	60	100	3000	960	100	1	0,20	10	90.011/012/24	
T	9,6	60	100	4000	960	100	1	0,20	10	90.011/011/24	
T	14,4	78	76.92	3000	1440	100	1	0,36	10	40904/IP67/24	
NEW	T	16	210	33.33	2700	1552	97	1	0,36	8	RB210208-2767
NEW	T	16	210	33.33	3000	1600	100	1	0,36	8	RB210208-3067
T	19,2	120	50	3000	1920	100	1	0,20	10	90.001/012PLUS24	
T	19,2	120	50	4000	1920	100	1	0,20	10	90.001/011PLUS24	

Le misure di cui sopra possono avere una tolleranza del 10%.  
The above measurements can have a 10% tolerance

\*Quantità dei LED per metro lineare  
Quantity of LEDs per linear metre

# LED Flex COB monocromatica 24 Vdc IP20 - IP67

## LED Flex COB monocromatica 24V.



A richiesta con consegna a 90 giorni:  
On request with delivery in 90 days:

- RED
- GREEN



CRI 90

IP20

	colour	W/m	Pitch	K	Lm/m	Efficiency	pcs	Kg	Width mm.	S+L
NEW	T	4	22.73	3000	340	85	1	0,20	3	RCOB528103-30
	T	10	45.45	3000	850	85	1	0,20	8	30904/COB
	T	10	45.45	4000	950	95	1	0,20	8	30904/COB/4K
NEW	B	10	45.45	BLUE	-	-	1	0,30	8	30904/COB/BL
NEW	T	15	45.45	3000	1500	100	1	0,30	10	RCOB528210-30
NEW	T	15	45.45	4000	1500	100	1	0,30	10	RCOB528210-40



A richiesta con consegna a 90 giorni, color 2200K - 2700K - 5000K e 6500K.  
On request with delivery in 90 days, color 2200K - 2700K - 5000K and 6500K.

CRI 90

IP67

	colour	W/m	Pitch	K	Lm/m	Efficiency	pcs	Kg	Width mm.	S+L
NEW	T	10	45.45	3000	950	95	1	0,20	8	30905/COB/3K
	T	10	45.45	4000	950	95	1	0,20	8	30905/COB

Le misure di cui sopra possono avere una tolleranza del 10%. - The above measurements can have a 10% tolerance

### Dati fotometrici Photometric data

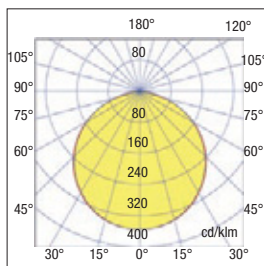

### Dimensioni - Dimension

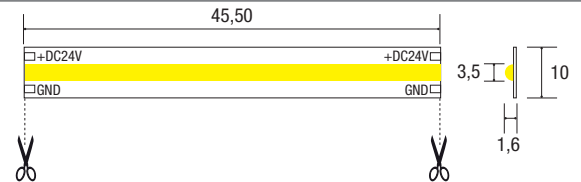

### Accessori inclusi - Included accessories



**Per codici IP20 - For IP20 codes**  
Cavi di connessione al driver  
Connection cables to the driver



Connettore per linea continua.  
Connector for continuous line.



**Per codici IP67 - For IP67 code**

La confezione contiene, clip di fissaggio, tappi di chiusura, cavi di collegamento IP ad alimentatore, tubo silicone per ripristino IP, connessioni iniziale e finale strip e per collegamento in serie. Le strip possono essere sezionate ad interassi prefissati; in caso di tagli intermedi utilizzare i tappi inclusi ed assicurarsi di sigillare accuratamente le estremità tagliate.

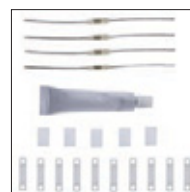

The package contains fixing clips, closure caps, IP connection cables to power supply, silicone hose for IP reset, initial and final strip connections and connection in series. The strips can be sectioned at preset intervals; in the case of intermediate cuts, use the included caps and make sure to carefully seal the cut ends

# LED FLEX COB VERTICAL IP67

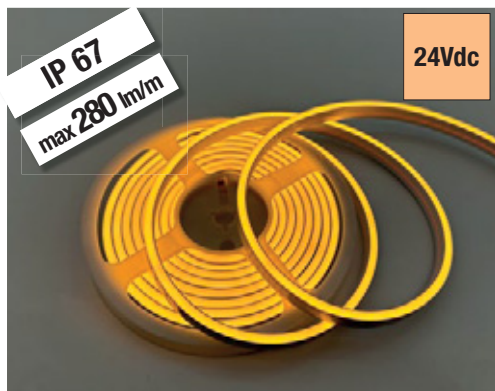

**CRI 90**

**IP67**

	colour	W/m	Led/mt*	Pitch	K	Lm/m	Lm/W	pcs	Kg	Width mm.	S+L
<b>NEW</b>	W	8	320	100	2500	240	30	1	0,26	6	RN3COB320208
					3500	256	32				
					5000	280	35				

## Dimensioni - Dimension

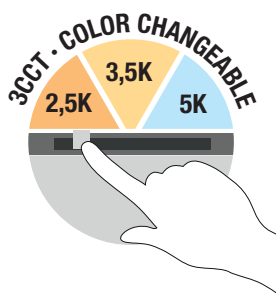
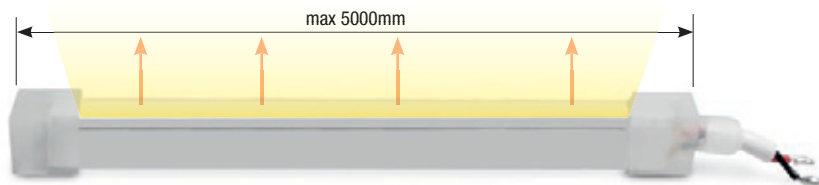
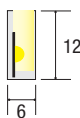
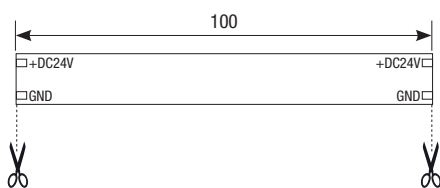

**3in1**

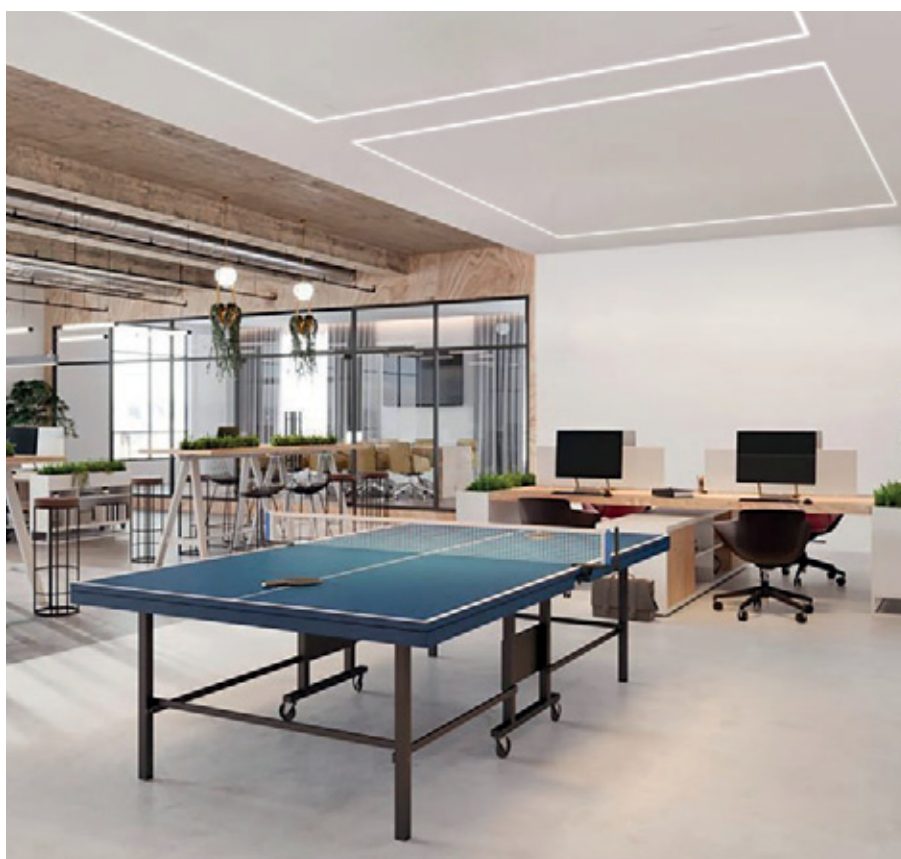
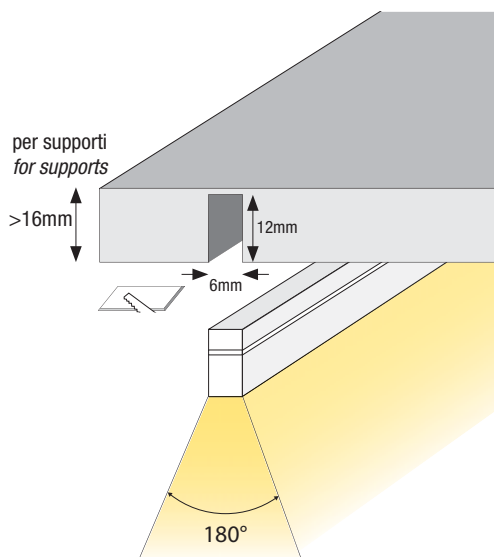
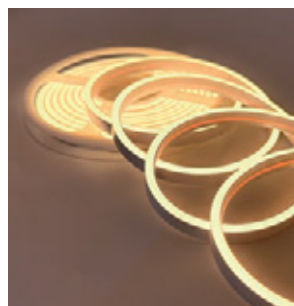
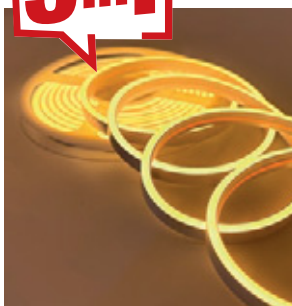

Stip LED

LED Flex COB Vertical può essere inserita su qualsiasi supporto, su cartongesso o inserita in mobili in legno, dopo aver predisposto il supporto a foro adeguato si inserisce semplicemente a pressione, inoltre non necessita di profili dissipanti visto la bassa potenza (8W/m) e di conseguenza l'esiguo calore emesso.

LED Flex COB Vertical can be inserted on any support, on plasterboard or inserted in wooden furniture, after having prepared the suitable hole support it is simply inserted by pressure, moreover it does not require dissipating profiles given the low power (8W/m) and consequently the little heat emitted.

# LED Flex Tunable white 24 Vdc IP20 - IP67

## LED Flex Tunable white

2700K



4000K



6500K



### Dati fotometrici Photometric data

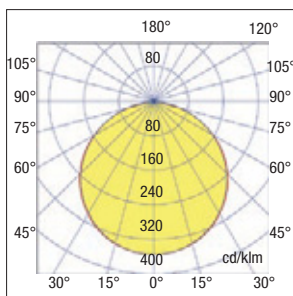

CRI 90

IP20

colour	W/m	Led/mt*	Pitch	K	Lm/m	Efficiency	pcs	Kg	Width mm.	S+L
T	15	120	50	2700 - 6500	1500	100	1	0,26	10	30937/TW

CRI 90

IP67

colour	W/m	Led/mt*	Pitch	K	Lm/m	Efficiency	pcs	Kg	Width mm.	S+L
T	9,6	60	100	2700 - 6500	960	100	1	0,30	12	30904/TW

Le misure di cui sopra possono avere una tolleranza del 10%.  
The above measurements can have a 10% tolerance

\*Quantità dei LED per metro lineare  
Quantity of LEDs per linear metre

### Temperature di colore dinamiche sull'esempio della natura

Non di rado, le persone trascorrono la maggior parte della giornata in ambienti chiusi. Grazie alla regolazione della temperatura di colore da bianco caldo a freddo, gli effetti naturali della luce e i relativi vantaggi entrano all'interno degli ambienti. Come hanno dimostrato gli studi, la luce fredda e molto azzurra stimola l'attività e la concentrazione, mentre la luce calda rilassa.

In questo modo Tunable White crea un ambiente capace di sostenere le persone in modo naturale, al pari di quanto fa la luce diurna.

Tunable White significa regolazione variabile della temperatura di colore dalla tonalità calda a quella fredda.

Se la temperatura di colore e l'illuminamento sono dosati correttamente, la luce artificiale è in grado di dare sostegno al benessere delle persone, sia in uffici e strutture didattiche che negli ospedali e nei centri di cura.

### Dynamic colour temperatures following nature's example

*Nature, in fact, has clearly showed us that even slight nuances are sufficient to affect people's moods and change the effect of things.*

*More and more often, people spend most of the day indoors. Thanks to the continuous adjustment of the colour temperature from warm to cold white, the natural effects of light and the relative advantages enter into the rooms.*

*As studies have shown, cold and very blue light stimulates activity and concentration, while warm light relaxes.*

*In this way, Tunable White creates an environment capable of supporting people in a natural way, just like daylight.*

*Tunable White means variable adjustment of the colour temperature from warm to cold.*

*If the colour temperature and illuminance are dosed correctly, artificial light is able to support people's well-being, both in offices and educational facilities as well as in hospitals and treatment centres.*

*Tunable White as a technology pioneer.*

### Accessori inclusi - Included accessories

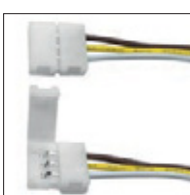

**Per codici IP20  
For IP20 codes**  
Cavi di connessione al driver  
Connection cables to the driver



Connettore per linea continua.  
Connector for continuous line.

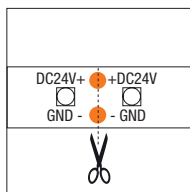

Effettuare il taglio in corrispondenza del simbolo della forbice e la linea tratteggiata.  
Make the cut in correspondence of the scissor symbol and dotted line.



**Per codici IP67 - For IP67 code**

La confezione contiene, clip di fissaggio, tappi di chiusura, cavi di collegamento IP ad alimentatore, tubo silicone per ripristino IP, connessioni iniziale e finale strip e per collegamento in serie. Le strip possono essere sezionate ad intervalli prefissati; in caso di tagli intermedi utilizzare i tappi inclusi ed assicurarsi di sigillare accuratamente le estremità tagliate.

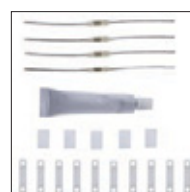

The package contains fixing clips, closure caps, IP connection cables to power supply, silicone hose for IP reset, initial and final strip connections and connection in series. The strips can be sectioned at preset intervals; in the case of intermediate cuts, use the included caps and make sure to carefully seal the cut ends

# LED FLEX RGB IP67

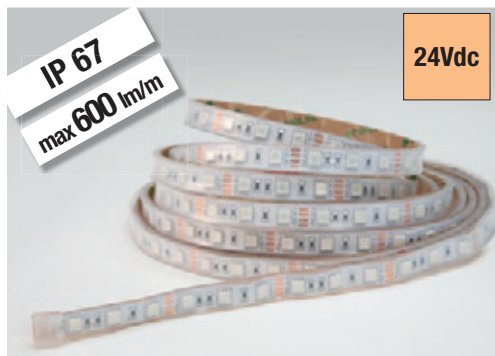

**IP67**

colour	W/m	Pitch	Led/mt*	Lm/m	Efficiency	pcs	Kg	S+L
T	14,4	60 LED RGB 5050	FULLCOLOR	600	42	1	0,38	90.001/RGB24V

Le misure di cui sopra possono avere una tolleranza del 10%.  
The above measurements can have a 10% tolerance

\*Quantità dei LED per metro lineare  
Quantity of LEDs per linear metre

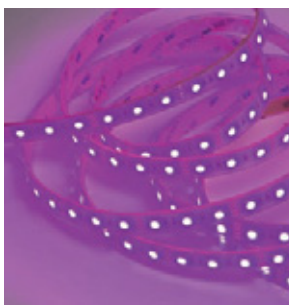

## Accessori inclusi - Included accessories

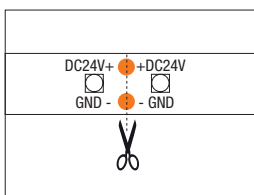

### Per codici IP67 - For IP67 code

La confezione contiene, clip di fissaggio, tappi di chiusura, cavi di collegamento IP ad alimentatore, tubo silicone per ripristino IP, connessioni iniziale e finale strip e per collegamento in serie. Le strip possono essere sezionate ad interassi prefissati; in caso di tagli intermedi utilizzare i tappi inclusi ed assicurarsi di sigillare accuratamente le estremità tagliate.

The package contains fixing clips, closure caps, IP connection cables to power supply, silicone hose for IP reset, initial and final strip connections and connection in series. The strips can be sectioned at preset intervals; in the case of intermediate cuts, use the included caps and make sure to carefully seal the cut ends.

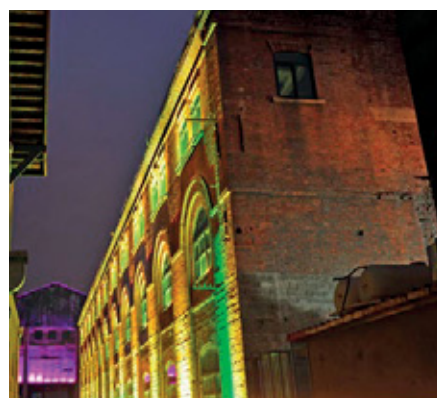

Effettuare il taglio in corrispondenza del simbolo della forbice e la linea tratteggiata.

Make the cut in correspondence of the scissor symbol and dotted line.

# LED Flex COB - Digital RGB 24 Vdc IP20



**CRI 90** **IP20**

colour	W/m	Pitch	K	Lm/m	Efficiency	pcs	Kg	Width mm.	S+L
T	6	100	Red	90	15	1	0,20	12	RCOB630212-D
	6		Green	240	40				
	6		Blue	48	8				
	14		Mixed white	350	25				

Faretti liberi senza copertura, ideali per illuminazione lineare e indiretta. Angolo del fascio di 180°, distribuzione più ampia rispetto ai 120° in SMD. Ingresso a bassa tensione 12Vdc per la sicurezza umana.

Spots free without cover, ideal for linear and indirect lighting. 180° beam angle, more wider distribution compared to 120° in SMD. 12Vdc low voltage input for human safety.

Le misure di cui sopra possono avere una tolleranza del 10%.  
The above measurements can have a 10% tolerance.

Le misure di cui sopra si basano su IP20.  
The above measurements are based on IP20.

# Profili in alluminio dissipanti

## Aluminium heat sink profile

Profilo **dissipante** in alluminio obbligatorio per LED Flex (non inclusa), con diffusore, clip di fissaggio e testata di chiusura (non inclusi) per installazione singola o in fila continua, a parete, a plafone o ad incasso.

**Materiale:** profilo **dissipante** in lega d'alluminio anodizzato naturale.

**Testata di chiusura:** in polimero termoplastico da ordinare separatamente.

**Diffusore:** trasparente o opale in PMMA da ordinare separatamente.

*Aluminium **heat sink** profile for LED Flex (not included), with diffuser, fastening clip and end caps (not included), suitable for single or in-line installation, wall, ceiling-mounted or recessed.*

**Material:** heat sink profile anodized aluminium alloy.

**End cap:** made of thermoplastic polymer to be ordered separately.

*Transparent or opal PMMA diffuser to be ordered separately.*

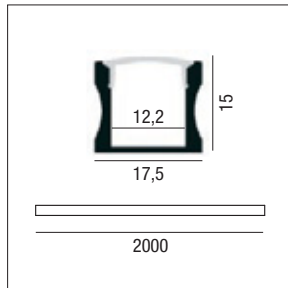

### KIT H 15

Profilo dissipante in alluminio. Lunghezza: 2 metri

### KIT H 15

Aluminium heat sink profile. Length: 2 meters

Art.	Finitura Finishing	Kg	L (mm)	Code
KIT H 15	Alluminio Aluminium	0,6	2000	20070

Per linee di luce continue  
For continuous lines of light

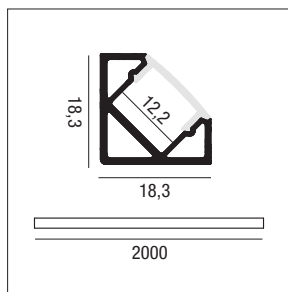

### KIT ANGOLO H 18,3

Profilo dissipante in alluminio. Lunghezza: 2 metri

### KIT CORNER H 18,3

Aluminium heat sink profile. Length: 2 meters

Art.	Finitura Finishing	Kg	L (mm)	Code
KIT ANGOLO H 18,3	Alluminio Aluminium	0,6	2000	20070-A

Per gole di luce continue  
For continuous cove lighting

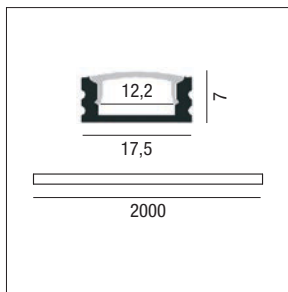

### KIT H 7

Profilo dissipante in alluminio. Lunghezza: 2 metri

### KIT CORNER H 7

Aluminium heat sink profile. Length: 2 meters

Art.	Finitura Finishing	Kg	L (mm)	Code
KIT H 7	Alluminio Aluminium	0,7	2000	20071

Per nicchie di luce continue  
For continuous light alcoves

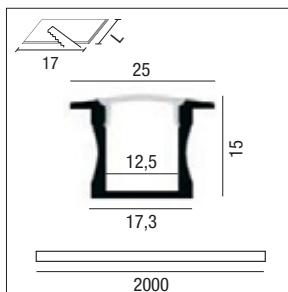

### Recessed KIT H 15

Profilo dissipante in alluminio **da incasso**. Lunghezza: 2 metri

### Recessed KIT H 15

Recessed aluminium heat sink profile. Length: 2 meters

Art.	Finitura Finishing	Kg	L (mm)	Code
Recessed KIT H 15	Alluminio Aluminium	0,7	2000	20070-I

Per linee di luce continue incassate in cartongesso  
For continuous recessed lines of light

## DIFFUSORI - accessori non inclusi - DIFFUSERS - accessories not included



**Code: D.20070-1**  
Diffusore **trasparente**.  
Lunghezza 2m.  
**Transparent** diffuser.  
Length 2m.



**Code: D.20070-2**  
Diffusore  **satinato**.  
Lunghezza 2m.  
**Satin-finished** diffuser.  
Length 2m.



# SLIM CV LED DRIVER - Uso indipendente - *Independent use*



Alimentatore indipendente IP20 per uso interno.  
Fornito di coprimorsetto e serracavo.

- Morsetti di entrata e uscita contrapposti
- Ripple di tensione:  $\pm 5\%$
- Campo di regolazione: 1-10V 1%-100% - DALI 2
- Tipo di protocollo: 1-10V - DALI 2
- Protezione: circuito aperto/Cortocircuito/Sovraccarico
- Protetto in classe II contro le scosse elettriche per contatti diretti e indiretti
- Temperatura ambiente:  $-20\dots45^{\circ}\text{C}$
- Temperatura di stoccaggio:  $40\dots85^{\circ}\text{C}$
- Certificati: ENEC / CCC / SAA / CB CE
- Applicazioni: striscia LED DC
- Tensione nominale: 220-240V - 50/60Hz

*IP20 independent power supply for indoor use.  
Supplied with terminal cover and cable clamp.*

- Opposite input and output terminals
- Voltage ripple:  $\pm 5\%$
- Setting range: 1-10V 1%-100% - DALI 2
- Protocol type: 1-10V - DALI 2
- Protection: Open Circuit / Short Circuit / Overload
- Protected in class II against electric shocks for direct and indirect contacts
- Ambient temperature:  $-20\dots45^{\circ}\text{C}$
- Storage temperature:  $40\dots85^{\circ}\text{C}$
- Certificates: ENEC / CCC / SAA / CB CE
- Applications: DC LED strip
- Rated voltage: 220-240V - 50/60Hz

	Codice Code	Watt Range	Output voltage Vdc	Output current mA	Input voltage Vdc	Hz			Protocol	Power factor	LxPxH (mm)	P (mm)	H (mm)
<b>NEW</b>	RN9175/48/120	120	48	0-2500 mA	-	50/60	15	25A 200 $\mu$ S	ON - OFF	0,95 $\lambda$	300	40	30
<b>NEW</b>	RN917548100DA	100	48	0-2500 mA	-	50/60	15	25A 200 $\mu$ S	DALI	0,95 $\lambda$	300	40	30
	RN9175/24	120	24	0-5000 mA	-	50/60	15	25A 200 $\mu$ S	ON - OFF	0,95 $\lambda$	300	40	30
<b>NEW</b>	9175150241-10	150	24	0-6250 mA	180-280	50/60	15	25A 200 $\mu$ S	1-10V	0,95 $\lambda$	350	30	18
<b>NEW</b>	917515024-DA	45-150	24	1875-6250 mA	180-280	50/60	15	25A 200 $\mu$ S	DALI	0,95 $\lambda$	350	30	18
<b>NEW</b>	91756024-DA	24-60	24	1000-2500 mA	180-280	50/60	25	20A 170 $\mu$ S	DALI	0,95 $\lambda$	300	30	15
<b>NEW</b>	RN9175/24/180	180	24	0-8350 mA	-	50/60	15	25A 200 $\mu$ S	ON - OFF	0,95 $\lambda$	345	50	35
	RN9175/24/200	200	24	0-75000 mA	-	50/60	15	25A 200 $\mu$ S	ON - OFF	0,95 $\lambda$	400	40	30

# FLAT CV LED DRIVER - Uso indipendente - *Independent use*



A richiesta potenze 12W - 24W - 36W - 120W - (ON-OFF - 1-10V - DALI) - *On request powers 12W - 24W - 36W - 120W (ON-OFF - 1-10V - DALI)*

	Codice Code	Watt Range	Output voltage Vdc	Output current mA	Input voltage Vdc	Hz			Protocol	Power factor	L (mm)	P (mm)	H (mm)
<b>NEW</b>	FLAT6024-1-10	60	24	0-2500 mA	230-280	50/60	25	20A 170 $\mu$ S	1-10V	0,95 $\lambda$	170	57	18
<b>NEW</b>	FLAT9024-1-10	90	24	0-3750 mA	230-280	50/60	15	25A 200 $\mu$ S	1-10V	0,95 $\lambda$	190	65	22
<b>NEW</b>	FLAT6024-DA	60	24	0-2500 mA	230-280	50/60	15	25A 200 $\mu$ S	DALI 2	0,95 $\lambda$	170	57	18
<b>NEW</b>	FLAT10024-DA	100	24	0-4200 mA	230-280	50/60	15	25A 200 $\mu$ S	DALI 2	0,95 $\lambda$	190	65	22

# COMPACT CV LED DRIVER - Uso indipendente - *Independent use*



- Alimentatore indipendente IP20 per uso interno.  
 Fornito di coprimorsetto e serracavo.
- Morsetti di entrata e uscita contrapposti
  - Ripple di tensione:  $\pm 5\%$
  - Campo di regolazione: 1-10V 1%-100%
  - Tipo di protocollo: 1-10V
  - Protezione: circuito aperto/Cortocircuito/Sovraccarico
  - Protetto in classe II contro le scosse elettriche per contatti diretti e indiretti
  - Temperatura ambiente:  $-20...45^{\circ}\text{C}$
  - Temperatura di stoccaggio:  $40..85^{\circ}\text{C}$
  - Certificati: ENEC / CCC / SAA / CB CE
  - Applicazioni: striscia LED DC
  - Tensione nominale: 220-240V - 50/60Hz

- IP20 independent power supply for indoor use.  
 Supplied with terminal cover and cable clamp.*
- *Opposite input and output terminals*
  - *Voltage ripple:  $\pm 5\%$*
  - *Setting range: 1-10V 1%-100% - DALI 2*
  - *Protocol type: 1-10V - DALI 2*
  - *Protection: Open Circuit / Short Circuit / Overload*
  - *Protected in class II against electric shocks for direct and indirect contacts*
  - *Ambient temperature:  $-20...45^{\circ}\text{C}$*
  - *Storage temperature:  $40..85^{\circ}\text{C}$*
  - *Certificates: ENEC / CCC / SAA / CB CE*
  - *Applications: DC LED strip*
  - *Rated voltage: 220-240V - 50/60Hz*

	Code Code	Watt Range	Output voltage Vdc	Output current	Hz	REGA?	IC	Protocol	Power factor	L (mm)	P (mm)	H (mm)
NEW	RN1399	8	24	334 mA	50/60	30	10A 40 $\mu\text{S}$	ON - OFF	*	68	35	20
NEW	RN9112	10	12	850 mA	50/60	30	10A 40 $\mu\text{S}$	ON - OFF	*	115	34	19
	RN9014	30	12	2500 mA	50/60	25	20A 175 $\mu\text{S}$	ON - OFF	0,95 $\lambda$	170	41	35
	PTDC/50/12V	60	12	5000 mA	50/60	15	20A 175 $\mu\text{S}$	ON - OFF	0,95 $\lambda$	180	52	30
	RN9175	100	12	8350 mA	50/60	15	20A 175 $\mu\text{S}$	ON - OFF	0,95 $\lambda$	230	51	40
	RN9124	15	24	625 mA	50/60	30	25A 200 $\mu\text{S}$	ON - OFF	*	115	34	19
	RN1366	25	24	1050 mA	50/60	25	20A 175 $\mu\text{S}$	ON - OFF	0,95 $\lambda$	123	38	28
	RN9015	30	24	1250 mA	50/60	25	20A 175 $\mu\text{S}$	ON - OFF	0,95 $\lambda$	170	41	35
	RN1432-24	40	24	1700 mA	50/60	25	20A 175 $\mu\text{S}$	ON - OFF	0,95 $\lambda$	185	46	38
	RN1428	60	24	2500 mA	50/60	15	10A 170 $\mu\text{S}$	ON - OFF	0,95 $\lambda$	180	52	30
	RN1392	25	12	2100 mA	50/60	25	20A 175 $\mu\text{S}$	ON - OFF	0,95 $\lambda$	145	39	28
			24	1000 mA								
	PTDC/80/B	50÷80	12	4170 mA	50/60	15	25A 200 $\mu\text{S}$	ON - OFF	0,95 $\lambda$	230	51	40
			24	3350 mA								
	PTDCD/100	60÷100	12	5000 mA	50/60	15	25A 200 $\mu\text{S}$	1-10V PUSH (SELV)	0,95 $\lambda$	230	51	40
			24	4170 mA								

\* Per potenze inferiori a 24W non è richiesto dalle normative - *For lower powers to 24W is not required by the regulations*

# COMPACT CV IP67 LED DRIVER - Uso indipendente - *Independent use*



A richiesta potenze 30W - 60W - 250W (ON-OFF - 1-10V - DALI)  
On request powers 30W - 60W - 250W (ON-OFF - 1-10V - DALI)

- Alimentatore indipendente IP67.
- Cavo di connessione su primario e secondario per il collegamento
  - Protetto in classe I contro le scosse elettriche per contatti diretti e indiretti
  - Ripple di tensione:  $\pm 5\%$
  - Campo di regolazione: DALI 2
  - Tipo di protocollo: DALI 2
  - Temperatura ambiente:  $-20...45^{\circ}\text{C}$
  - Temperatura di stoccaggio:  $40...85^{\circ}\text{C}$
  - Certificati: ENEC / CCC / SAA / CB CE
  - Applicazioni: striscia LED DC
  - Tensione nominale: 220-240V - 50/60Hz

- IP67 independent power supply.*
- Connection cable on primary and secondary for connection
  - Class I protected against electric shocks for direct and indirect contacts
  - Voltage ripple:  $\pm 5\%$
  - Setting range: DALI 2
  - Protocol type: DALI 2
  - Ambient temperature:  $-20...45^{\circ}\text{C}$
  - Storage temperature:  $40...85^{\circ}\text{C}$
  - Certificates: ENEC / CCC / SAA / CB CE
  - Applications: DC LED strip
  - Rated voltage: 220-240V - 50/60Hz

Code Code	Watt Range	Output voltage Vdc	Output current mA	Hz	STRA? ?	iC	Protocol	Power factor	L (mm)	P (mm)	H (mm)
RN1431/75	75	12	6250 mA	50/60	15	25A 200µs	ON - OFF	0,95 λ	155	53	31
RN1431	150	12	12500 mA	50/60	15	25A 200µs	ON - OFF	0,95 λ	215	53	31
RN1475/24/DA	75	24	3125 mA	50/60	15	25A 200µs	DALI	0,95 λ	131	67	33
RN1431/24/100	100	24	4160 mA	50/60	15	25A 200µs	ON - OFF	0,95 λ	200	53	31
RN1227	150	24	6250 mA	50/60	15	25A 200µs	DALI	0,95 λ	161	67	33
RN1431/24	200	24	8330 mA	50/60	15	25A 200µs	ON - OFF	0,95 λ	240	53	31

# SLIM CV LED DRIVER - Da incorporare - *Built in*



- Alimentatore da incorporare IP20 per uso interno.  
Utilizzabile per apparecchi di illuminazione in classe di protezione I  
Fornito di coprimorsetto e serracavo.
- Morsetti di entrata e uscita contrapposti
  - Ripple di tensione:  $\pm 5\%$
  - Protezione: circuito aperto/Cortocircuito/Sovraccarico
  - Temperatura ambiente:  $-20...45^{\circ}\text{C}$
  - Temperatura di stoccaggio:  $40...85^{\circ}\text{C}$
  - Certificati: ENEC / CCC / SAA / CB CE
  - Applicazioni: striscia LED DC
  - Tensione nominale: 220-240V - 50/60Hz

- Power supply to be incorporated IP20 for internal use.*  
*Can be used for luminaires in protection class I*  
*Supplied with terminal cover and cable clamp.*
- Opposite input and output terminals
  - Voltage ripple:  $\pm 5\%$
  - Protection: Open Circuit / Short Circuit / Overload
  - Ambient temperature:  $-20...45^{\circ}\text{C}$
  - Storage temperature:  $40...85^{\circ}\text{C}$
  - Certificates: ENEC / CCC / SAA / CB CE
  - Applications: DC LED strip
  - Rated voltage: 220-240V - 50/60Hz

Code Code	Watt Range	Output voltage Vdc	Output current mA	Hz	STRA? ?	iC	Protocol	Power factor	L (mm)	P (mm)	H (mm)
RN1279	60	24	2500 mA	50/60	15	25A 200µs	DALI 2	0,95 λ	250	30	21
RN1279/100	100	24	4160 mA	50/60	15	25A 200µs	DALI 2	0,95 λ	250	30	21

# KZQ-3 - Push-button DIM - 0-10V DIM - DIM

Controller per strisce LED monocromatiche o RGB - *Controller for monochromatic or RGB strip LED*



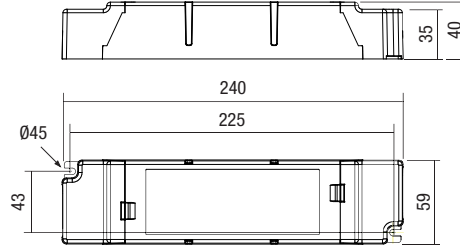

Dimensioni (mm) - *Dimensions (mm)*



**Norme di riferimento**  
*Reference Standards:*

**Sicurezza - Safety:**  
EN 61347-1;  
EN 61347-2-11

Codice Code	LPH ↓ mm	Vdc IN		W	A	ta °C	tc °C	Vout Vdc	PCS		CCM cm³
30948	240x53x40	12	P - S10 DALI	200	17	-20...40	80	12	1		670,82
		24	P - S10 DALI	400				24			



Dimensioni (mm) - *Dimensions (mm)*

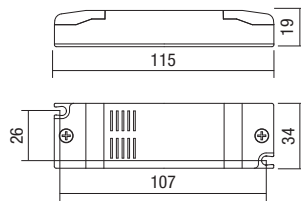

**Codice Code**

**DMXPWM/RGB/B**

**Controller per STRISCE LED RGB - MONOCROMATICHE - TUNABLE WHITE (Bianco Dinamico)**

KZQ-3 è un controller per uso indipendente per strisce LED in tensione a 12Vdc o 24Vdc:

- LED RGB
- LED Monocromatiche
- LED Tunable White (bianco dinamico)

**Caratteristiche:**

- Dimmer tipo PWM in bassa tensione per uso indipendente
- Alimentazione in bassissima tensione di sicurezza 12/24Vdc
- Utilizzabile per apparecchi in classe III
- Regolazione: pulsante selv / pulsante non selv / 0÷10Vdc / 1÷10Vdc / DALI / DMX (con interfaccia DMX/PWM)
- Impostazione delle funzioni tramite dip-switch
- Morsetti di entrata e uscita contrapposti
- Sezione morsetti di entrata 2,5mm / AWG13
- Sezione morsetti di uscita 4mm / AWG11
- Possibilità di sincronizzazione, fino ad un massimo di 10 unità, tramite cavi di sincronismo (cod. CON/MSL/RGB)

KZQ-3, in abbinamento agli alimentatori della serie MINILED a tensione costante 12Vdc oppure 24Vdc, è in grado di gestire come singola apparecchiatura fino ad un massimo di 200W (12Vdc) - 400W (24Vdc) di potenza di strisce LED, la scelta del tipo di alimentatore 12Vdc o 24Vdc ed anche la potenza è da effettuare in base al tipo di striscia LED utilizzata.

**RGB LED Strip Controller - MONOCHROME - TUNABLE WHITE (Dynamic White)**

KZQ-3 is a controller for independent use of LED strips in a 12Vdc or 24Vdc system:

- RGB LEDs
- Monochrome LEDs
- Tunable White (dynamic white) LEDs

**Characteristics:**

- Low voltage PWM type dimmer for independent use
  - Safety extra low voltage power supply 12/24Vdc
  - Usable for class III appliances
  - Adjustment: SELV push-button / non SELV push-button / 0÷10Vdc / 1÷10Vdc / DALI / DMX (with DMX/PWM interface)
  - Function setting via dip-switch
  - Opposite input and output terminals
  - Input terminal section 2.5mm / AWG13
  - Output terminal section 4mm / AWG11
  - Possibility to synchronise up to a maximum of 10 units via sync cable (cod. CON/MSL/RGB)
- KZQ-3, combined with 12Vdc or 24Vdc constant voltage power supply units of the MINI-LED range, can manage up to a maximum of 200W (12Vdc) - 400W (24Vdc) power LED strips as single equipment; select a 12Vdc or 24Vdc power supply unit as well as the power required based on the type of LED strip used.

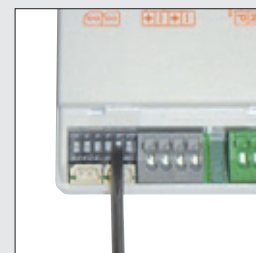

Fornito di dip switch per la selezione della tensione in uscita  
Equipped with dip switch for selecting the voltage output

**Cod. CON/MSL/RGB**

Nel caso in cui sia necessaria gestire una potenza maggiore, sarà possibile collegare in modo sincronizzato, tramite cavo di sincronismo (cod. CON/MSL/RGB), fino ad un massimo di 10 apparecchiature selezionando, con i dip-switch, il funzionamento MASTER-SLAVE.

Should greater power be needed, up to a maximum of 10 devices can be connected in a synchronized way, using a sync cable (cod. CON/MSL/RGB), by selecting MASTER-SLAVE operation via dip-switches.

# KZQ-4

Interfaccia per dimmerazione di LED in tensione 24-48Vdc con comando a pulsante e segnale DALI e 0/1-10V  
Interface for 24-48Vdc voltage LED dimming with push-button control and DALI and 0/1-10V signal



Dimensioni (mm) - Dimensions (mm)

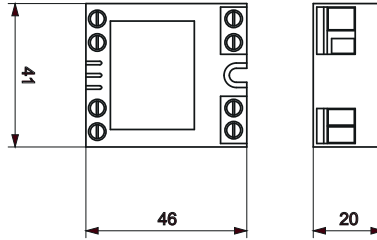

**Norme di riferimento**  
**Reference Standards:**

- EN 55015
- EN 61000-3-2
- EN 61347-1
- EN 61347-2-13
- EN 61547
- EN 62384
- EN 62396-207

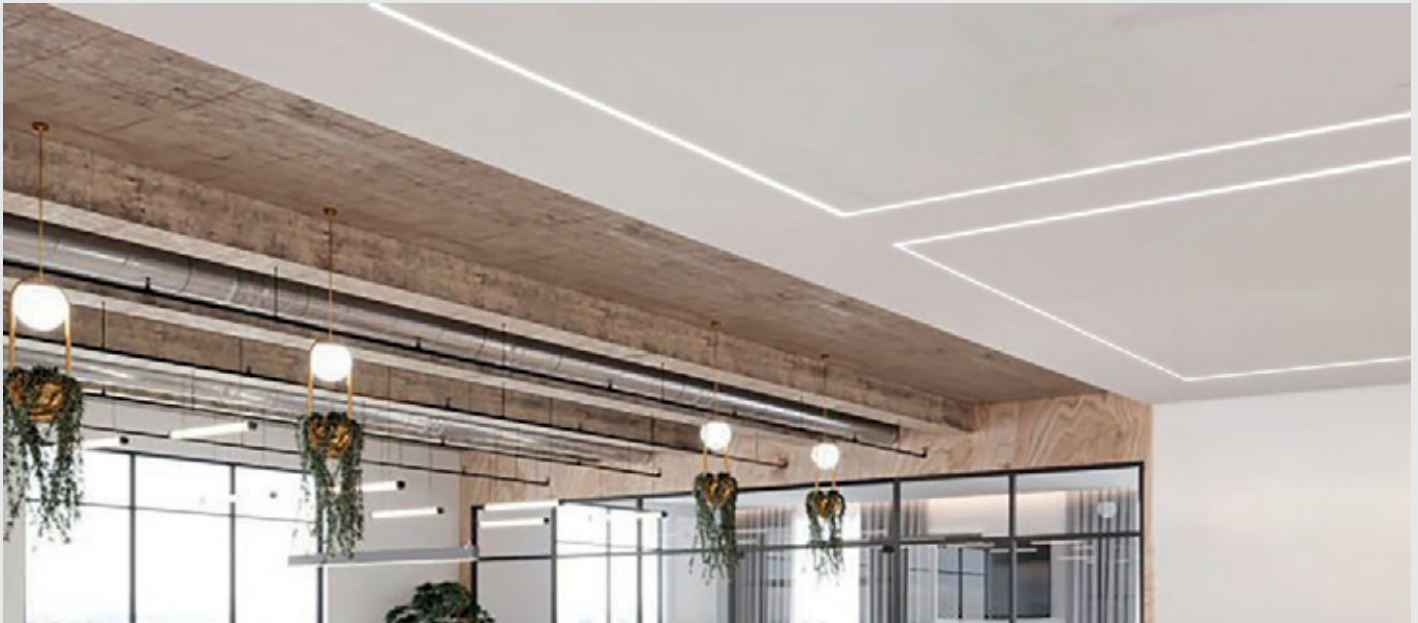

**Caratteristiche costruttive**

- Involucro plastico
- Dispositivo non per uso indipendente
- Classe III = Apparecchio in bassa tensione di sicurezza

**Caratteristiche tecniche**

- Tensione di ingresso e di uscita 24-48Vdc
- Variatore di luminosità per moduli LED 24Vdc o 48Vdc
- Variatione delle luminosità tramite:
  - Pulsante (PUSH no voltage)
  - Potenziometro 47K $\Omega$
- Frequenza della tensione di uscita PWM: 250Hz
- Sintonizzazione di più interfacce tramite cablaggio (max 10)
- Funzione "MEMORIA DI LIVELLO"
- Funzione "MEMORIA DI STATO" (ultimo valore prima del black-out)
- Protezione al corto circuito
- Temperatura ambiente di funzionamento Ta -15°C÷40°C
- Temperatura massima sul punto Tc 80°C

**Construction features**

- Plastic casing
- Device not for independent use
- Class III = Safety low voltage device

**Technical features**

- Input voltage and output voltage 24-48Vdc
- Dimmer for 24Vdc or 48Vdc LED modules
- Brightness adjustment via:
  - Button (PUSH no voltage)
  - Potentiometer 47K $\Omega$
- PWM output voltage frequency: 250Hz
- Tuning of multiple interfaces via wiring (max 10)
- "LEVEL MEMORY" function
- "STATUS MEMORY" function (last value before blackout)
- Short Circuit Protection
- Ambient operating temperature Ta -15°C÷40°C
- Maximum temperature on the Tc point 80°C

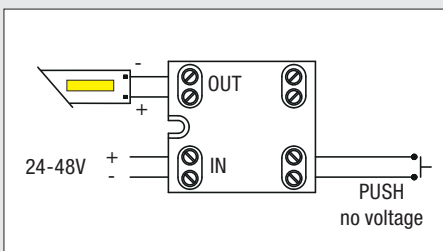

Modalità PUSH no voltage  
PUSH no voltage mode

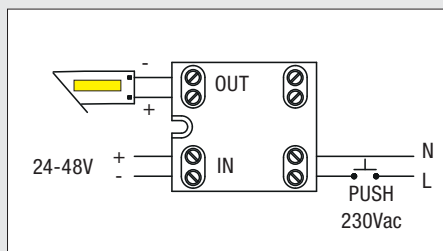

Modalità PUSH 230Vac  
PUSH 230Vac mode

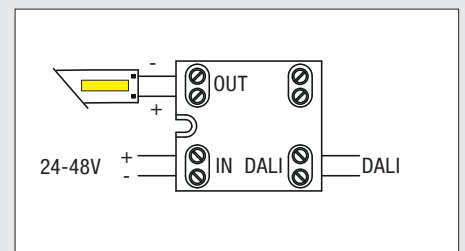

Modalità DALI  
DALI mode

# LED Classica

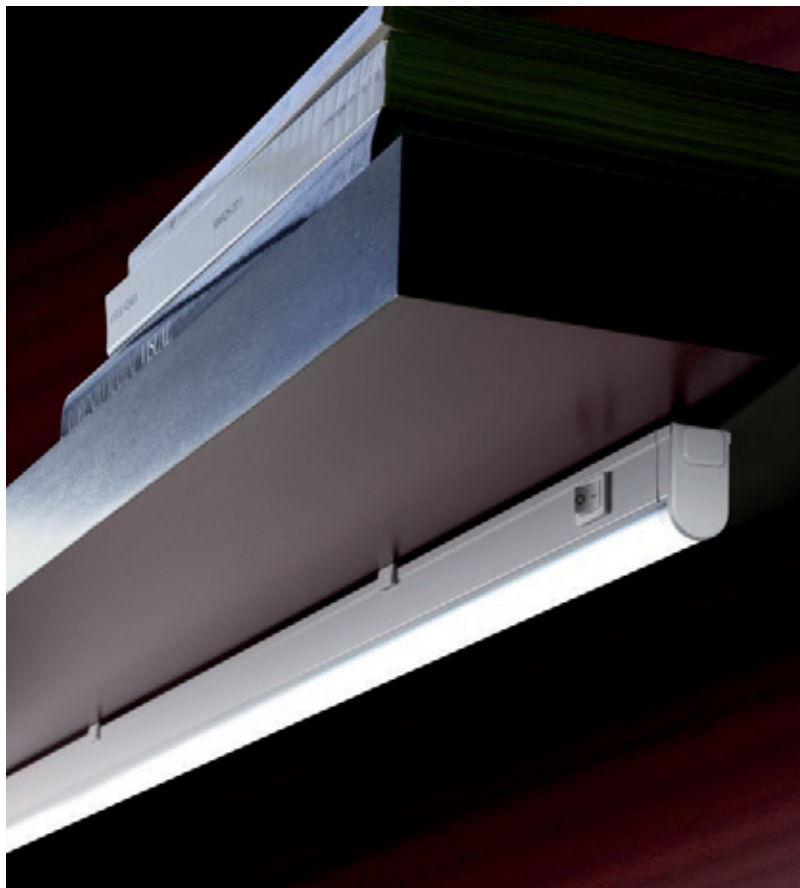

Reglette con tecnologia a led in grado di ridurre notevolmente i consumi rispetto ad una tradizionale reglette. Durata oltre 20.000 ore conforme alle normative di sicurezza.

LED Classica ha il vantaggio del tuttoshermo con l'effetto linea di luce continua.

**Installazione:** soffitto e parete

**Corpo:** in policarbonato Bianco

**Schermo:** diffusore rigato in PMMA

**Cablaggio incluso:** cavo di 1,8m e spina, cavo di 15 cm con due connettori.

**Alimentazione:** inclusa

**Interruttore:** ON/OFF incorporato

Provvista di clip per il fissaggio rapido.

*LED technology reglette with significant power economy and energy saving compared to conventional lighting fixture. Long life which last for over 20.000 hours and is fully compliant with applicable safety regulations.*

*LED Classica has the widescreen with an effect of continuous light brightening line.*

**Installation:** ceiling and wall

**Body:** in White polycarbonate

**Shield:** PMMA diffuser

**Wiring included:** 1,8m wire and plug, 15cm wire with two connector.

**Power supply:** included

**Switch:** incorporated ON/OFF

Clips included for easy fixing.



LED Classica astucci - LED Classica packing

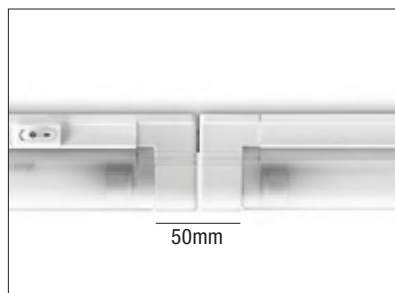
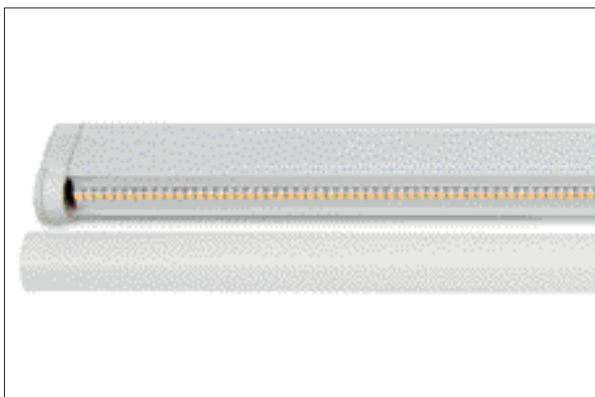

È possibile cablare le lampade in serie fino ad un massimo di 10 lampade. Si suggerisce comunque di utilizzare lampade della stessa potenza. Diversamente potrebbero notarsi piccole differenze di colore tra lampade di diversa potenza.

*The lamps can be connected in series up to max 10 lamps. You are however advised to use lamps of the same power. Lamps of different power can cause variations in colour.*

**LED Classica**



288 (4W)  
516 (7W)  
849 (14W)  
1149 (20W)  
1449 (22W)

A richiesta  
**6000K**  
On request



colour	W			Lm	K	pcs	Kg	CELL		
B	4	* (8W)	180°	350	4000	001	0.40	28610		
B	7	* (13W)	180°	650	4000	001	0.40	28611		
B	7	* (13W)	180°	650	3000	001	0.40	28613		
B	14	* (21W)	180°	1250	4000	001	0.40	28603		
B	14	* (21W)	180°	1150	3000	001	0.40	28605	Netto 6,00	QTY** 6000
B	20	* (28W)	180°	1850	4000	001	0.50	28604		
B	20	* (28W)	180°	1750	3000	001	0.50	28606		
B	22	* (35W)	180°	1950	4000	001	0.60	28614		

\* Potenza FLUO corrispondente - *Corresponding FLUO lamp power*

\*\* Fino ad esaurimento - *Offer valid while supplies last*



**Accessori inclusi - Included accessories**

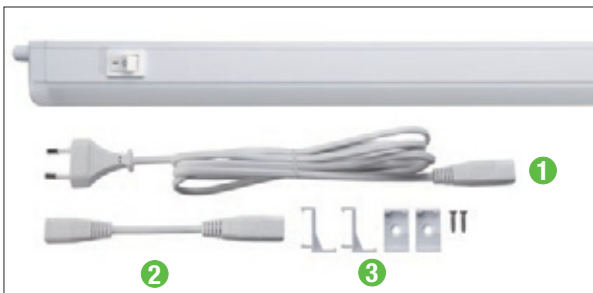

- 1 Cod. 24153**  
Cavo di 1,8m con connettore e spina - *1,8m wire with connector and plug*
- 2 Cod. 24157**  
Cavo di 15cm con 2 connettori - *15cm wire with two connector*
- 3 Cod. 24154**  
Accessori fissaggio - *Fixing accessories*

**Accessori non inclusi - Not included accessories**



- 1 Cod. 24151**  
Cavo di 1,8m con connettore a 90° - *1,8m wire with connector at 90°*
- 2 Cod. 24121**  
Cavo di 1m con due connettori - *1m wire with 2 connectors*
- 3 Cod. 24156**  
Cavo di 30cm con due connettori - *30cm wire with two connectors*
- 4 Cod. 24159**  
Cavo di 50cm con due connettori - *50 cm wire with two connectors*
- 5 Cod. 24160**  
Cavo di 50cm con 2 connettori a 90° - *50cm wire with two 90° connectors*

# ILLUMINAZIONE DI SICUREZZA - SAFETY LIGHTING

La gamma di lampade di emergenza Relco è creata per garantire l'illuminazione in caso di black-out, aumentando il livello di sicurezza in ogni ambiente.

Perfette per ogni tipo di abitazione, rispondono alla Norma CEI 64-8 che esige l'installazione di lampade ad accensione automatica in caso di mancanza di illuminazione ordinaria.

The range of Relco emergency lamps are created to ensure lighting in the event of a blackout, increasing the level of safety in any environment.

Perfect for any type of home, they comply with the CEI 64-8 standard which requires the installation of lamps with automatic switch-on in the event of a lack of ordinary lighting.

**Nemko CERTIFICATE**  
No. P18223203

Order No. 311270 Page 1 of 1

Product: LED emergency light, wall mounted

Applicant: Relco Srl  
Via delle Azzalee 6/A  
20090 Buccinasco (MI)  
Italy

Manufacturer: Relco Srl  
Via delle Azzalee 6/A  
20090 Buccinasco (MI)  
Italy

Ratings: 6 W 220-230 V ~ 50-60 Hz, Class II, IP42.

Trade mark: Relco or Relco Sud

Model / Type Ref.: 1) VENERE 40 LED SA-SE-3A, 2) VENERE 40 LED SA-SE-1A

Principal characteristics: 1) Ni-Cd battery, test device 3 h emergency duration;  
2) Ni-Cd battery, test device 1 h emergency duration

A sample of the product was tested and found to be in conformity with: LITE EN 60598-2-22:2014  
EN 60598-1:2015

Validity: This certificate documents conformity with the standards shown, and also applies as license for use of Nemko name and certification mark. The certificate and license is valid as long as the applicable conditions are complied with, and provided that any changes to the product are notified to Nemko for acceptance prior to implementation. New standards or amendments to the standards may imply that the product design must be updated and/or that re-testing and re-certification is necessary.

Additional information: Compliance with requirements regarding electromagnetic compatibility (EMC) is based on a self declaration from the manufacturer/representative according to the European EMC Directive.

Additional model(s): No additional models

Date of issue 28-11-2018

*Ok Hyun Jeon*  
Okhyun Jeon  
Certification Department

Nemko AS  
Gaustadalleen 30, P.O. Box 73 Blindern, 0314 Oslo, Norway  
TEL: +47 22 96 02 30 FAX: +47 22 96 02 50 EMAIL: info@nemko.com  
ENTERPRISE NUMBER NO974404532

**Nemko CERTIFICATE**  
No. P18223226

Order No. 316635 Page 1 of 1

Product: LED emergency light, wall mounted

Applicant: Relco Srl  
Via delle Azzalee 6/A  
20090 Buccinasco (MI)  
Italy

Manufacturer: Relco Srl  
Via delle Azzalee 6/A  
20090 Buccinasco (MI)  
Italy

Ratings: 3 W 220-230 V ~ 50-60 Hz, Class II, IP42

Trade mark: Relco or Relco Sud

Model / Type Ref.: 1) SIRIO 20 LED SA-SE-3A, 2) SIRIO 20 LED SA-SE-1A

Principal characteristics: 1) Ni-Cd battery, test device 3 h emergency duration;  
2) Ni-Cd battery, test device 1 h emergency duration

A sample of the product was tested and found to be in conformity with: LITE EN 60598-2-22:2014  
EN 60598-1:2015

Validity: This certificate documents conformity with the standards shown, and also applies as license for use of Nemko name and certification mark. The certificate and license is valid as long as the applicable conditions are complied with, and provided that any changes to the product are notified to Nemko for acceptance prior to implementation. New standards or amendments to the standards may imply that the product design must be updated and/or that re-testing and re-certification is necessary.

Additional information: No additional models

Additional model(s): No additional models

Date of issue 28-11-2018

*Ok Hyun Jeon*  
Okhyun Jeon  
Certification Department

Nemko AS  
Gaustadalleen 30, P.O. Box 73 Blindern, 0314 Oslo, Norway  
TEL: +47 22 96 02 30 FAX: +47 22 96 02 50 EMAIL: info@nemko.com  
ENTERPRISE NUMBER NO974404532

## Control Panel



## Router



## Osiride emergenza Autotest





## Osiride segnalazione Autotest



## Spot Emer SE 3h Autotest



## Raja W-C-R Autotest



## Orione



## Venere MyWay»



## Sirio



## Venere



## Accessori Sirio - Venere

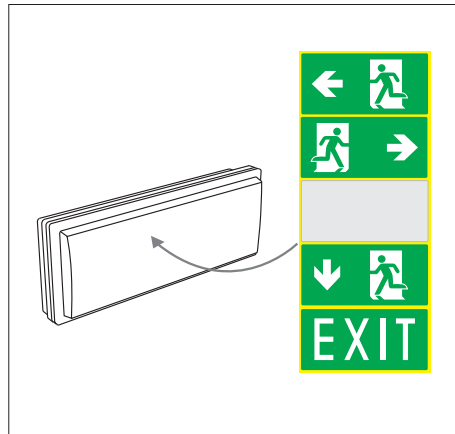

## AT Autotest



## Spot Emer SE 3h Autotest



## Cuculo



## Keyemer



## Come scegliere l'illuminazione di Sicurezza - How to choose Safety lighting

La direzione delle vie di fuga e le uscite devono essere riconoscibili tramite la segnaletica e l'illuminazione di sicurezza: queste variano secondo la concentrazione di persone, il numero di piani, la posizione, l'estensione e l'uso degli edifici, secondo gli impianti o i compartimenti antincendio.

The direction of the escape route and the exits must be recognizable through safety signs and lighting: these vary according to the concentration of people, the number of floors, the location, extension and use of the buildings, according to the fire systems or compartments.

### Posizionamento delle lampade di emergenza

A) **La direzione delle vie di fuga** deve essere opportunamente contrassegnata nel caso non sia immediatamente visibile o se l'ambiente è frequentato da persone che non hanno confidenza con la geometria del luogo (ad esempio scale, corridoi, cambi di direzione).

### Positioning of emergency lamps

A) The direction of the escape route must be suitably marked if it is not immediately visible or if the room is frequented by people who are not familiar with the geometry of the place (for example stairs, corridors, changes of direction).

B) **Vanno contrassegnate** le uscite che non siano immediatamente identificabili come tali o che vengano usate solo in caso di emergenza.

B) Exits that are not immediately identifiable as such or that are only used in an emergency must be marked.

C) **La segnaletica deve essere** facilmente riconoscibile e posizionata in modo tale che chiunque, da qualsiasi posizione nel locale, possa individuare almeno un pittogramma segnaletico.

C) The signs must be easily recognizable and positioned in such a way that anyone, from any position in the room, can identify at least one sign pictogram.

D) **La segnaletica delle vie di fuga** e delle uscite deve essere installata in modo unitario all'interno di un unico edificio.

D) Signage of escape routes and exits must be installed in a uniform way within a single building.

E) **La segnaletica per identificare le vie di fuga** e le uscite va collocata in posizione trasversale rispetto alla direzione da seguire, in modo tale che in caso di incendio non venga prematuramente oscurata dal fumo ed ad almeno 0.5 m dal soffitto in ambienti dove è rilevante la presenza di fumo in caso di incendio (CIE S 020/E).

E) The signs to identify escape routes and exits must be placed in a transverse position with respect to the direction to be followed, so that in the event of a fire it is not prematurely obscured by smoke and at least 0.5 m from the ceiling in environments where there is a significant presence of smoke in the event of a fire (CIE S 020/E).

## PHOTOMETRY DATA (1W)

Illuminazione Area Aperta (Antipánico) (per min. 0,5 lux)			Illuminazione via di fuga (per min. 1 lux)		
Open Area (Anti-Panic) Lighting (for min. 0,5 lux)			Escape Route Lighting (for min. 1 lux)		
Altezza di montaggio (m) Mounting Height (m)	Distanza tra apparecchio e parete (m) Distance Between Luminaire and Wall (m)	Distanza tra gli apparecchi (m) Distance Between Luminaires (m)	Altezza di montaggio (m) Mounting Height (m)	Distanza tra apparecchio e parete (m) Distance Between Luminaire and Wall (m)	Distanza tra gli apparecchi (m) Distance Between Luminaires (m)
2,00	2,00	3,00	2,00	2,00	3,50
2,50	2,25	4,00	2,50	2,25	4,25
3,00	2,75	4,75	3,00	2,50	4,50
3,50	2,75	5,50	3,50	2,50	5,00
4,00	2,75	6,00	4,00	2,25	5,25

## PHOTOMETRY DATA (2W)

Illuminazione Area Aperta (Antipánico) (per min. 0,5 lux)			Illuminazione via di fuga (per min. 1 lux)		
Open Area (Anti-Panic) Lighting (for min. 0,5 lux)			Escape Route Lighting (for min. 1 lux)		
Altezza di montaggio (m) Mounting Height (m)	Distanza tra apparecchio e parete (m) Distance Between Luminaire and Wall (m)	Distanza tra gli apparecchi (m) Distance Between Luminaires (m)	Altezza di montaggio (m) Mounting Height (m)	Distanza tra apparecchio e parete (m) Distance Between Luminaire and Wall (m)	Distanza tra gli apparecchi (m) Distance Between Luminaires (m)
2,00	2,50	4,50	2,00	2,50	5
2,50	3	5,75	2,50	3	6
3,00	3,50	6,75	3,00	3,25	6,50
3,50	3,75	7,50	3,50	3,50	7
4,00	4	8	4,00	3,75	7,50

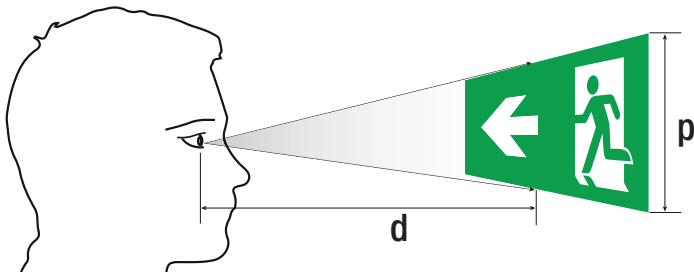

**Pittogrammi illuminati esternamente**  
Externally illuminated pictograms

Distanza di riconoscimento <b>d</b> [m] Recognition distance <b>d</b> [m]	Lunghezza laterale minima <b>p</b> [mm] Minimum lateral length <b>p</b> [mm]
15	150
20	200
35	250

**$d = s \times p$**

<b>d</b>		distanza di riconoscimento in m <i>recognition distance in m</i>
<b>p</b>		altezza del pittogramma <i>pictogram height</i>
<b>s</b>	costante <i>constant</i>	100 per pittogramma illuminato esternamente <i>100 per externally lit pictogram</i>
		200 per pittogramma illuminato internamente <i>200 per internally lit pictogram</i>

**Pittogrammi retroilluminati o illuminati internamente**  
Backlit or internally lit pictograms

Distanza di riconoscimento <b>d</b> [m] Recognition distance <b>d</b> [m]	Lunghezza laterale minima <b>p</b> [mm] Minimum lateral length <b>p</b> [mm]
30	150
40	200
70	250

**PHOTOMETRY DATA (3W)**

Illuminazione Area Aperta (Antipanico) (per min. 0,5 lux) Open Area (Anti-Panic) Lighting (for min. 0,5 lux)			Illuminazione via di fuga (per min. 1 lux) Escape Route Lighting (for min. 1 lux)		
Altezza di montaggio (m) Mounting Height (m)	Distanza tra apparecchio e parete (m) Distance Between Luminaire and Wall (m)	Distanza tra gli apparecchi (m) Distance Between Luminaires (m)	Altezza di montaggio (m) Mounting Height (m)	Distanza tra apparecchio e parete (m) Distance Between Luminaire and Wall (m)	Distanza tra gli apparecchi (m) Distance Between Luminaires (m)
2,00	3,00	5,50	2,00	3,00	5,75
2,50	3,50	6,75	2,50	3,50	7,00
3,00	4,00	7,75	3,00	4,00	7,75
3,50	4,25	8,50	3,50	4,25	8,50
4,00	4,50	9,25	4,00	4,25	9,25

**PHOTOMETRY DATA (5W)**

Illuminazione Area Aperta (Antipanico) (per min. 0,5 lux) (Lente simmetrica) Open Area (Anti-Panic) Lighting (for min. 0,5 lux) (Symmetric Lens)			Illuminazione via di fuga (per min. 1 lux) Escape Route Lighting (for min. 1 lux)		
Altezza di montaggio (m) Mounting Height (m)	Distanza tra apparecchio e parete (m) Distance Between Luminaire and Wall (m)	Distanza tra gli apparecchi (m) Distance Between Luminaires (m)	Altezza di montaggio (m) Mounting Height (m)	Distanza tra apparecchio e parete (m) Distance Between Luminaire and Wall (m)	Distanza tra gli apparecchi (m) Distance Between Luminaires (m)
2,00	3,50	7	2,00	3,50	7
2,50	4	8,50	2,50	4	8,75
3,00	4,50	9,50	3,00	5	9,50
3,50	5,25	10,50	3,50	5,25	10,50
4,00	5,50	11,25	4,00	5,50	11,50

**LED Safety Lighting**  
 Tabella di scelta - Choice table



# EMERGENCY EXIT LUMINAIRES - LED CONTROLLER DALI

## DALI

Digital Addressable Lighting Interface (DALI) è un protocollo di comunicazione aperto sviluppato dai principali produttori nel settore dell'illuminazione ed è definito nello standard tecnico internazionale IEC 62386.

Il protocollo DALI, che è stato sviluppato inizialmente per i sistemi di illuminazione controllabili, al momento include molte tecnologie di illuminazione intelligenti e i requisiti per l'illuminazione di emergenza sono inclusi nell'ambito dello standard. Fornisce la massima flessibilità e facilità per progettisti di sistemi, società di progettazione/installazione/montaggio e utenti finali ed è una piattaforma di comunicazione molto sicura e stabile per l'illuminazione di emergenza, per il monitoraggio delle luci di emergenza in conformità con il regolamento sulla protezione antincendio degli edifici e la norma EN / IEC 50172.

In qualità di membro attivo dell'organizzazione DALI, Relco progetta e produce prodotti e sistemi di illuminazione di emergenza conformi allo standard DALI.

Nel nostro laboratorio di ricerca e sviluppo, progetti di circuiti originali e software integrato vengono sviluppati per unità di illuminazione di emergenza conformi a DALI e apparecchi per uscite di emergenza. Con l'utilizzo di nuove tecnologie, la nostra famiglia di prodotti che produciamo nei nostri stabilimenti viene ulteriormente ampliata. Relco, in qualità di membro dell'organizzazione DiiA che regola gli standard DALI, garantisce la conformità DALI dei suoi prodotti con il ProbitLab - DALI Tester nel suo laboratorio di ricerca e sviluppo. Relco, come membro di DiiA, applica il logo DALI ai suoi prodotti che superano tutti i test con successo.

Digital Addressable Lighting Interface (DALI) is an open communication protocol developed by the leading producers in the lighting industry and is defined in international IEC 62386 technical standard.

DALI protocol, which was developed for controllable lighting ballasts at the beginning, includes many smart lighting technologies at the moment and requirements for Emergency Lighting is included in scope of the standard. It provides maximum flexibility and easiness for system designers, project/installation/montage firms and final users and a very secure and stable communication platform for emergency lighting for monitoring emergency lights in compliance with the Regulation on Fire Protection of Buildings and EN / IEC 50172 Standard.

As an active member of DALI organization, Relco designs and manufactures DALI compliant emergency lighting products and systems.

In our R&D laboratory, original circuit designs and embedded software are developed for DALI compliant emergency lightings units and emergency exit luminaires. With using new technologies; our product family which we manufacture in our facilities is further expanded. Relco, as a member of the DiiA organization regulates DALI standards, warrants the DALI compliance of its products with the ProbitLab - DALI Tester in its R & D Laboratory. Relco, as a member of DiiA, it applies the DALI logo to its products that pass all tests successfully.

## WIRED MONITORING SYSTEM

è la nostra soluzione di sistema di monitoraggio cablato che consente di monitorare lo stato dei prodotti di illuminazione di emergenza compatibili DALI tramite router e pannello touch screen

- Monitoraggio centralizzato tramite pannello di controllo touch screen
- Sistema di illuminazione di emergenza indirizzabile secondo gli standard EN e IEC
- Test funzionali e di autonomia istantanei o periodici
- Software di controllo per test, reporting e registrazione dei rapporti di test
- Interfaccia utente protetta da password
- Cablaggio bus dati standard DALI omnidirezionale e a 2 fili

is our wired monitoring system solution that allows you to monitor status of DALI compatible emergency lighting products via router and touch screen panel.

- Central monitoring via touch screen control panel
- Addressable emergency lighting system according to EN and IEC standards
- Instant or periodic functional and duration tests
- Control software for testing, reporting and recording test reports
- Password protected user interface
- Omnidirectional and 2-wired standard DALI data bus cabling

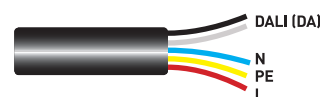

# EMERGENCY EXIT LUMINAIRES - LED CONTROLLER DALI

## MONITORING AND CONTROL PANEL



### CONTROL PANEL - Codice R00326

- RTC (orologio in tempo reale).
- Schermo tattile da 7 pollici.
- 1x Ethernet RJ45: Internet TCP/IP.
- 1 ingresso RS485: per il collegamento di 16 router DALI (max. 2048 dispositivi di illuminazione di emergenza conformi a DALI).
- 230VAC 50/60Hz
- Test funzionali e di autonomia dei dispositivi di illuminazione di emergenza DALI compliant.
- Monitoraggio dello stato della batteria e della lampada LED.
- Segnalazione e registrazione dei risultati dei test

### CONTROL PANEL - Code R00326

- RTC (Real Time Clock).
- 7 inch touch screen.
- 1x RJ45 Ethernet : TCP/IP Internet.
- 1x RS485 input: for 16 x DALI Router connection (max. 2048 DALI compliant emergency lighting device)
- 230VAC 50/60 Hz
- Functional and duration tests of DALI compliant emergency lighting devices.
- Status Monitoring of battery and LED lamp
- Reporting and recording test results



### ROUTER - Codice R00327

- 2 uscite: max. 128 connessioni per dispositivi di illuminazione di emergenza conformi a DALI.
- 1 ingresso RS485: per il collegamento del pannello di controllo touch screen.
- 230VAC 50/60Hz

### ROUTER - Code R00327

- 2x Outputs: Max. 128 x DALI compliant emergency lighting device connection.
- 1x RS485 input: For connection of touch screen control panel.
- 230VAC 50/60Hz

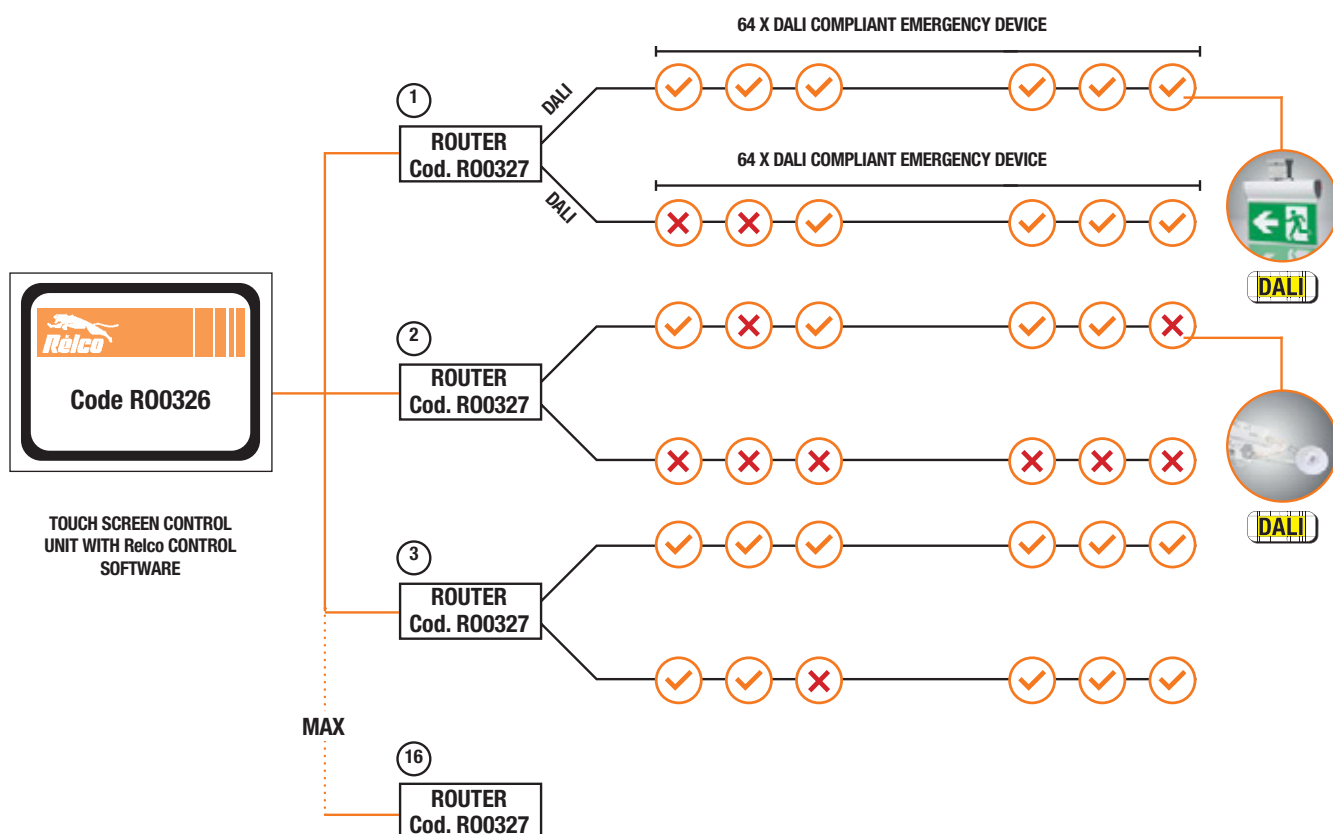

**AUTOTEST**

# EMERGENCY LIGHTING LUMINAIRES – LED LED OSIRIDE EMEGENZA DALI AUTOTEST



Uso interno ed esterno.  
Corpo e vetro in policarbonato.  
A prova di umidità.  
Applicazione LED SMD.  
Elevato risparmio energetico.  
Lunga durata (50.000 ore).  
Funzione di illuminazione di emergenza mediante interruzione della fase non commutata.  
Funzione di illuminazione di emergenza in caso di bassa tensione.  
Durata 3 ore in caso di emergenza.  
Indicatore di stato con LED verdi e rossi.  
Interruttore di prova.  
Controllo remoto e test con interfaccia DALI.  
Celle della batteria Ni-Cd ad alta temperatura.  
Protezione da sovraccarico e scarica profonda.  
A soffitto, incasso a soffitto o a parete.  
Opzionale - Compatibilità 110 VAC.  
Opzionale - Applicazione batteria LiFePO4 o Ni-MH.

*Indoor and outdoor use.  
Polycarbonate case and glass.  
Moisture-proof.  
SMD LED application.  
High energy saving.  
Long life-time (50.000 hours).  
Emergency lighting function by interruption of the unswitched phase.  
Emergency lighting function in case of low-voltage.  
3 hours duration in case of emergency.  
Status display with green and red LEDs.  
Test switch.  
Remote control and test with DALI interface.  
High-temperature Ni-Cd battery cells.  
Overcharge and deep discharge protection.  
Ceiling mounted, ceiling recessed or wall mounted.  
Optional - 110 VAC compatibility.  
Optional - LiFePO4 or Ni-MH battery application.*

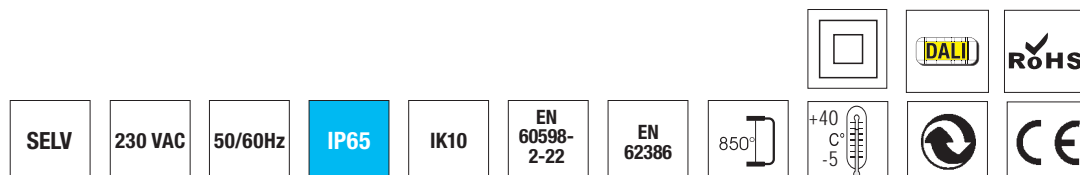

Conforme alle norme EN 60598-1, EN 60598-2-22, EN 62386.

In accordance with EN 60598-1, EN 60598-2-22, EN 62386 standards.

## TECHNICAL DATA

TENSIONE DI ALIMENTAZIONE SUPPLY VOLTAGE	230 VAC 50/60 Hz	SORGENTE LUMINOSA LIGHT SOURCE	SMD LED
TEMPERATURA AMBIENTE (ta) AMBIENT TEMPERATURE (ta)	-5 °C ... +40 °C	DIFFUSORE DIFFUSER	Policarbonato Polycarbonate Glass
DURATA NOMINALE RATED DURATION	3 h	CLASSE DI PROTEZIONE PROTECTION CLASS	IP 65
TEMPO DI CARICA DELLA BATTERIA BATTERY CHARGING TIME	24 h	CLASSE DI ISOLAMENTO INSULATION CLASS	II
TIPO DI BATTERIA BATTERY TYPE	3,6 V Ni-Cd		

## LED INDICATION FUNCTIONS

VERDE permanente <i>Permanent GREEN</i>	Modalità di ricarica	<i>Charge mode</i>
VERDE lampeggiante veloce (0,1s acceso - 0,1s spento) <i>Fast flashing GREEN (0,1s on - 0,1s off)</i>	Test di funzionalità	<i>Function test</i>
VERDE lampeggiante lento (1s acceso - 1s spento) <i>Slow flashing GREEN (1s on - 1s off)</i>	Prova di durata	<i>Duration test</i>
ROSSO permanente <i>Permanent RED</i>	Errore di carico	<i>Load failure</i>
ROSSO lampeggiante lento (1s acceso - 1s spento) <i>Slow flashing RED (1s on - 1s off)</i>	Guasto della batteria	<i>Battery failure</i>
ROSSO lampeggiante veloce (0,1s acceso - 0,1s spento) <i>Fast flashing RED (0,1s on - 0,1s off)</i>	Errore di ricarica	<i>Charging failure</i>
Doppia lampeggio VERDE <i>Double pulsing GREEN</i>	Modalità inibizione	<i>Inhibit mode</i>
Trasmissione binaria dell'indirizzo via VERDE/ROSSO <i>Binary transmission of address via GREEN/RED</i>	Indirizzamento o identificazione	<i>Addressing or identification</i>
VERDE e ROSSO spenti <i>GREEN and RED off</i>	Modalità di emergenza	<i>Emergency mode</i>

## TEST SWITCH FUNCTIONS

Pressione breve (<1s) <i>Short press (&lt;1s)</i>	Avvia il test di funzionalità o termina tutti i test.	<i>Starts the function test or terminate the all tests.</i>
Pressione lunga (>5s) <i>Long press (&gt;5s)</i>	Test di durata	<i>Starts the duration test.</i>

## PRODUCT LIST

CODICE PRODOTTO PRODUCT CODE	W	DURATA NOMINALE RATED DURATION	MODALITÀ OPERATIVA* OPERATING MODE*		SORGENTE LUMINOSA LIGHT SOURCE	INTENSITÀ LUMINOSA accesa ENERGIA/EMERGENZA LIGHT INTENSITY on ENERGY/EMERGENCY	TIPO DI MONTAGGIO TYPE of MOUNTING	BATTERIA TEMPO DI CARICA BATTERY CHARGING TIME
1957L20SAREL	1	3 h	SA	Permanente* Maintained*	20 x SMD LED	115 lm / 115 lm	Recessed Surface Mounted	24 h
1957L20SEREL	3	3 h	SE	Non Permanente** Non-Maintained**	20 x SMD LED	-/350 lm.	Recessed Surface Mounted	24 h

\* Sempre accesa / *always on*

\*\* Si illumina in caso di mancanza di rete / Lights in case of the mains failure.

## MAINS DATA

CODICE PRODOTTO PRODUCT CODE	POTENZA NOMINALE (W)* RATED POWER (W)*	CORRENTE DI RETE (A)* MAINS CURRENT (A)*	FATTORE DI POTENZA (PF)* POWER FACTOR (PF)*	DIMENSIONI (mm) DIMENSION (mm)	PESO (Kg) WEIGHT (Kg)	Q.TA in cartone Q.TY in CARTON BOX
1957L20SAREL	5,05	0,036	0,60	108 x 341 x 60	0,630	1
1957L20SEREL	2,60	0,024	0,45	108 x 341 x 60	0,780	1

\* Misurato con rete a 230 V.

\* Measured under 230 V mains.

## LIGHT DISTRIBUTION CURVE

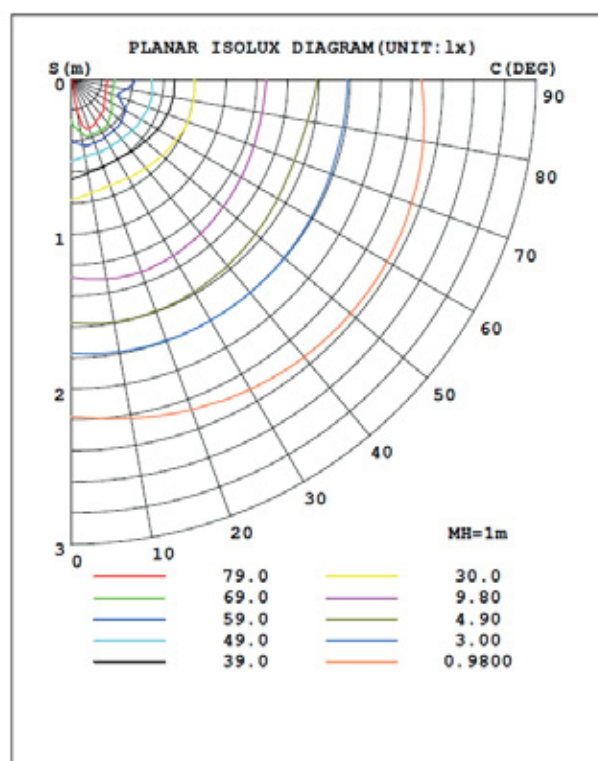
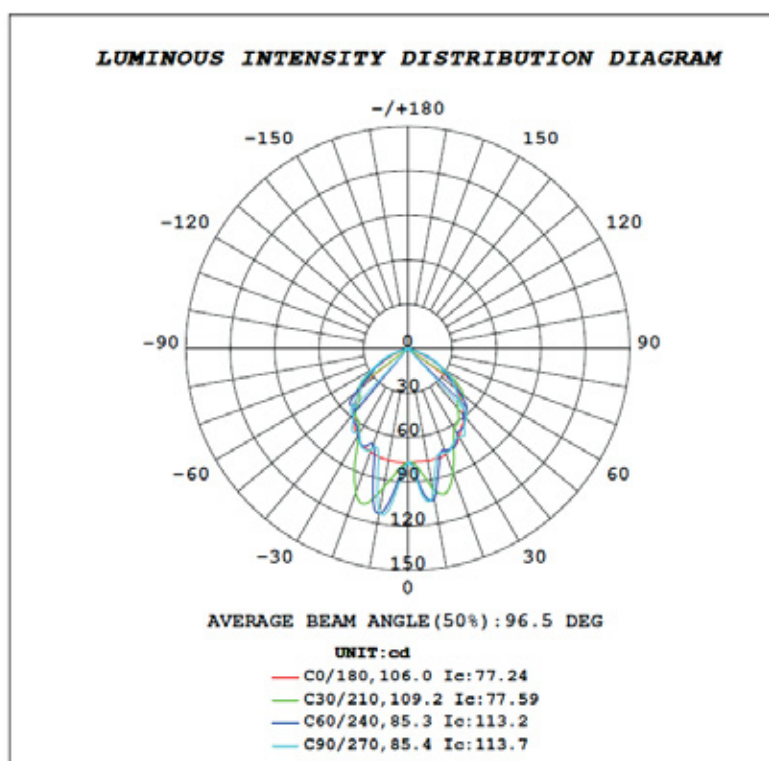



**AUTOTEST**

# EMERGENCY LIGHTING LUMINAIRES – LED LED OSIRIDE EMERGENZA DALI AUTOTEST

## TECHNICAL DRAWING / SURFACE MOUNTED

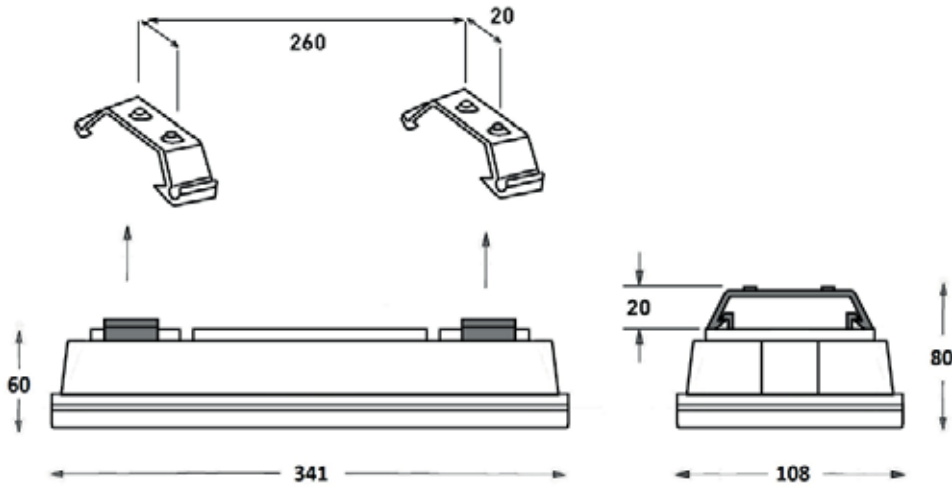

## TECHNICAL DRAWING / RECESSED MOUNTED

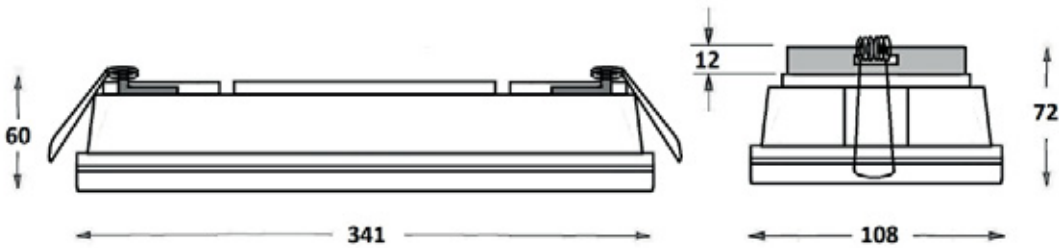
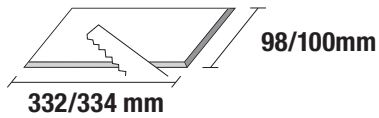

## WIRING DIAGRAM

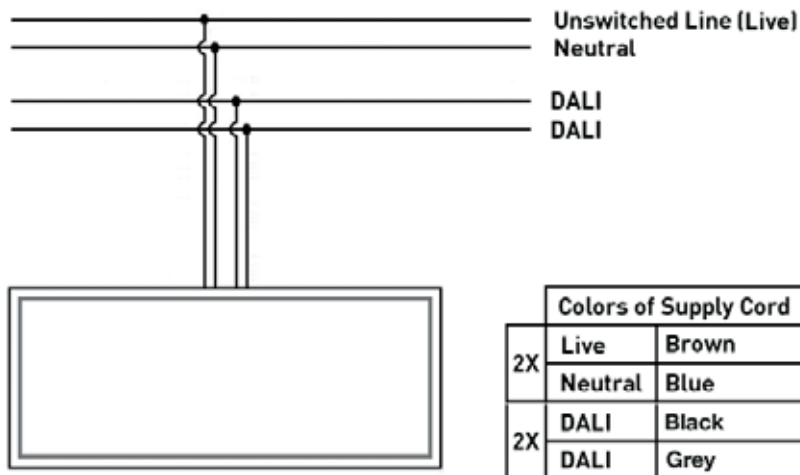





DALI

LED Safety Lighting

**AUTOTEST**

# EMERGENCY EXIT LUMINAIRES - LED LED OSIRIDE SEGNALAZIONE DALI AUTOTEST



Monofacciale o bifacciale.  
Cassa in alluminio anodizzato.  
Copertura laterale e gancio in policarbonato.  
Applicazione LED SMD.  
Indicatore di stato con LED verde e rosso.  
Interruttore di prova.  
Controllo remoto e test con interfaccia DALI.  
Celle della batteria Ni-Cd ad alta temperatura.  
Protezione da sovraccarico e scarica profonda.  
Plexiglas trasparente con serigrafia.  
Illuminazione laterale.  
A soffitto, incasso a soffitto o a parete.  
Opzionale - Compatibilità 110 VAC.  
Opzionale - Sistema di fissaggio metallo, gancio o filo d'acciaio.  
Opzionale - Applicazione batteria LiFePO4 o Ni-MH.

*Single- or double-sided  
Anodized aluminum case  
Polycarbonate side cover and hanger  
SMD LED application  
Status display with green and red LED  
Test switch  
Remote control and test with DALI interface  
High-temperature Ni-Cd battery cells  
Overcharge and deep discharge protection  
Transparent Plexiglas with screen printed  
Side lighting  
Ceiling mounted, ceiling recessed or wall mounted  
Optional - 110 VAC compatibility  
Optional - Metal hanger, hook or steel wire  
Optional - LiFePO4 or Ni-MH battery application*

--	--	--	--	--	--	--	--	--	--	--	--

Conforme alle norme EN 60598-1, EN 60598-2-22, EN 62386.

In accordance with EN 60598-1, EN 60598-2-22, EN 62386 standards.

## TECHNICAL DATA

TENSIONE DI ALIMENTAZIONE SUPPLY VOLTAGE	230 VAC 50/60 Hz	DIMENSIONI PITTGRAMMA SIGN DIMENSIONS	180 x 299 mm
TEMPERATURA AMBIENTE (ta) AMBIENT TEMPERATURE (ta)	0 °C ... +40 °C	DISTANZA DI VISIONE VIEWING DISTANCE	
DURATA NOMINALE RATED DURATION	3 h	CLASSE DI PROTEZIONE PROTECTION CLASS	IP 20
TEMPO DI CARICA DELLA BATTERIA BATTERY CHARGING TIME	24 h	CLASSE DI ISOLAMENTO INSULATION CLASS	I
TIPO DI BATTERIA BATTERY TYPE	3,6 V Ni-Cd		

## LED INDICATION FUNCTIONS

VERDE permanente <i>Permanent GREEN</i>	Modalità di ricarica	<i>Charge mode</i>
VERDE lampeggiante veloce (0,1s acceso - 0,1s spento) <i>Fast flashing GREEN (0,1s on - 0,1s off)</i>	Test di funzionalità	<i>Function test</i>
VERDE lampeggiante lento (1s acceso - 1s spento) <i>Slow flashing GREEN (1s on - 1s off)</i>	Prova di durata	<i>Duration test</i>
ROSSO permanente <i>Permanent RED</i>	Errore di carico	<i>Load failure</i>
ROSSO lampeggiante lento (1s acceso - 1s spento) <i>Slow flashing RED (1s on - 1s off)</i>	Guasto della batteria	<i>Battery failure</i>
ROSSO lampeggiante veloce (0,1s acceso - 0,1s spento) <i>Fast flashing RED (0,1s on - 0,1s off)</i>	Errore di ricarica	<i>Charging failure</i>
Doppia lampeggio VERDE <i>Double pulsing GREEN</i>	Modalità inibizione	<i>Inhibit mode</i>
Trasmissione binaria dell'indirizzo via VERDE/ROSSO <i>Binary transmission of address via GREEN/RED</i>	Indirizzamento o identificazione	<i>Addressing or identification</i>
VERDE e ROSSO spenti <i>GREEN and RED off</i>	Modalità di emergenza	<i>Emergency mode</i>

## TEST SWITCH FUNCTIONS

\* La batteria deve essere carica al 100% prima di poter avviare il test di autonomia.

\* The battery must be 100% full before the duration test can be started.

Pressione breve (<1s) <i>Short press (&lt;1s)</i>	Avvia il test di funzionalità o termina tutti i test.	<i>Starts the function test or terminate the all tests.</i>
Pressione lunga (>5s)* <i>Long press (&gt;5s)*</i>	Test di durata	<i>Starts the duration test.</i>

## PRODUCT LIST

CODICE PRODOTTO	DURATA NOMINALE	MODALITÀ OPERATIVA		SORGENTE LUMINOSA	MODALITÀ	TIPO DI MONTAGGIO
PRODUCT CODE	W	RATED DURATION	OPERATING MODE		SINGLE/DOUBLE SIDED	TYPE of MOUNTING
1957L12SAREL	4	3 h	SA	Permanente* Maintained*	12 x SMD LED	Surface Mounted - Plastic Hanger

\* Permanente: si accende in presenza di rete e rimane accesa in caso di mancanza di rete.

\* Maintained: Lights on mains and stays on in case of the mains failure.

## MAINS DATA

CODICE PRODOTTO	POTENZA NOMINALE (W)*	CORRENTE DI RETE (A)*	FATTORE DI POTENZA (PF)*	DIMENSIONI (mm)	PESO (Kg)	Q.TA in cartone
PRODUCT CODE	RATED POWER (W)*	MAINS CURRENT (A)*	POWER FACTOR (PF)*	DIMENSION (mm)	WEIGHT (Kg)	Q.TY in CARTON BOX
1957L12SAREL	4,82	0,032	0,63	40 x 304 x 235	0,700	1

\* Misurato con rete a 230 V.

\* Measured under 230 V mains.

## WIRING DIAGRAM

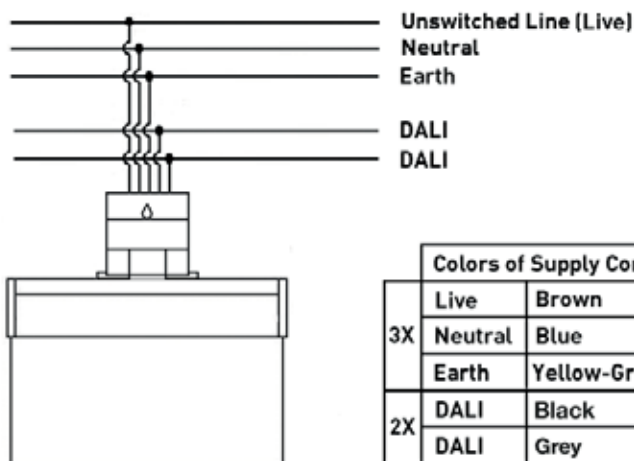

## TECHNICAL DRAWING / SURFACE MOUNTED

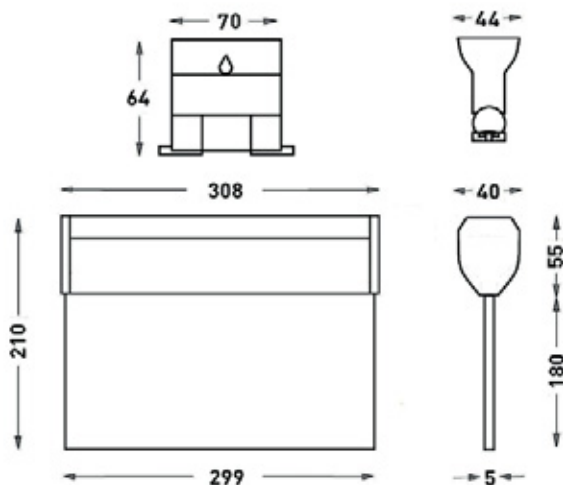

DALI 2

AUTOTEST

# EMERGENCY LIGHTING LUMINAIRES – LED

## LED SPOT EMER DALI SE 3W 3H AUTOTEST



Apparecchio di illuminazione di emergenza indipendente con interfaccia Dali e test automatico.

Modulo di emergenza a LED adatto per l'installazione diretta a soffitto.

Set completo con elettronica integrata, modulo LED, custodia e batteria.

Luce di emergenza spot da incasso con lente per area aperta e corridoio.

Alimentatore bus DALI integrato.

Policarbonato bianco RAL 9016.

Pacco batterie LiFePO4 integrato.

Perdita di potenza in stand-by molto bassa.

Modalità non permanente.

Tensione di uscita SELV.

Filo incandescente 850°.

2 anni di garanzia parte elettronica.

Batteria con garanzia di 4 anni.

Independent emergency lighting fixture with Dali interface and automatic test function.

LED emergency module suitable for direct installation in ceilings.

Complete set with integrated electronics, LED module, housing, and battery.

Recessed spot emergency light with open area and corridor lens.

Integrated DALI bus power supply.

Polycarbonate white RAL 9016.

Integral LiFePO4 battery pack.

Very low stand-by power loss.

Non-maintained mode.

SELV output voltage.

850°Glow-wire.

2 years guarantee electronic.

4-year guarantee battery.

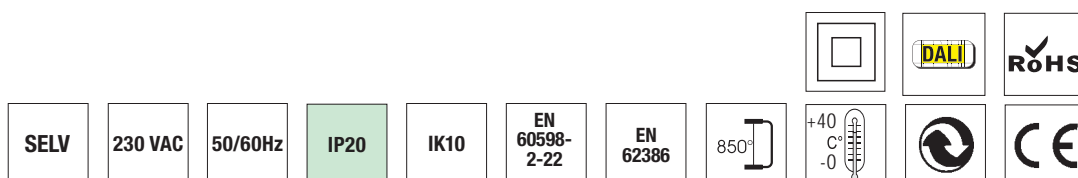

Conforme alle norme EN 60598-1, EN 60598-2-22, EN 62386.

In accordance with EN 60598-1, EN 60598-2-22, EN 62386 standards.

### TECHNICAL DATA

TENSIONE DI ALIMENTAZIONE SUPPLY VOLTAGE	230 VAC 50/60 Hz	SORGENTE LUMINOSA LIGHT SOURCE	Power LED
TEMPERATURA AMBIENTE (ta) AMBIENT TEMPERATURE (ta)	0 °C ... +40 °C	DIFFUSORE DIFFUSER	LENTE simmetrica / asimmetrica Symmetric / Asymmetric LENS
DURATA NOMINALE RATED DURATION	3 h	CLASSE DI PROTEZIONE PROTECTION CLASS	IP 20
TEMPO DI CARICA DELLA BATTERIA BATTERY CHARGING TIME	24 h	CLASSE DI ISOLAMENTO INSULATION CLASS	II
TIPO DI BATTERIA BATTERY TYPE	6,4 V LiFePO4		

### LED INDICATION FUNCTIONS

VERDE permanente <i>Permanent GREEN</i>	Modalità di ricarica	<i>Charge mode</i>
VERDE lampeggiante veloce (0,25s acceso - 0,25s spento) <i>Fast flashing GREEN (0,25s on - 0,25s off)</i>	Test di funzionalità	<i>Function test</i>
VERDE lampeggiante lento (1s acceso - 1s spento) <i>Slow flashing GREEN (1s on - 1s off)</i>	Prova di durata	<i>Duration test</i>
ROSSO permanente <i>Permanent RED</i>	Guasto lampada	<i>Open circuit or short circuit or LED failure</i>
ROSSO lampeggiante lento (1s acceso - 1s spento) <i>Slow flashing RED (1s on - 1s off)</i>	Guasto della batteria	<i>Battery failure</i>
ROSSO lampeggiante veloce (0,25s acceso - 0,25s spento) <i>Fast flashing RED (0,25s on - 0,25s off)</i>	Errore di ricarica	<i>Battery failed duration test</i>
Trasmissione binaria dell'indirizzo via VERDE/ROSSO <i>Binary transmission of address via GREEN/RED</i>	Indirizzamento o identificazione	<i>Addressing or identification</i>
VERDE e ROSSO spenti <i>GREEN and RED off</i>	Modalità di emergenza	<i>Emergency mode</i>

CODICE PRODOTTO PRODUCT CODE	INPUT DATA	OUTPUT POWER	SORGENTE LUMINOSA LIGHT SOURCE	LUMEN OUTPUT (0/C)	CHARGE TIME	DURATION	BATTERY
8550RELD	220-240V	3W	Power LED	250LM/185LM	24H	3H	6,4V 1500mAh LiFePO4

BATTERY DATA

VOLTAGGIO VOLTAGE	CAPACITÀ CAPACITY	TIPO CELLULARE CELL TYPE	DIMENSIONE CELLA CELL SIZE (mm)	QUANTITÀ DI CELLE QTY OF CELLS	DIMENSIONI DIMENSIONS (mm)	PESO WEIGHT (g)
3.2V	18650	LiFePO4	Ø18X65mm	2	Ø18X65mm	43.3



TWO LENS INCLUDED

RECESSED MOUNTING HOLE SIZE

CORRIDOR LENS

OPEN AREA LENS

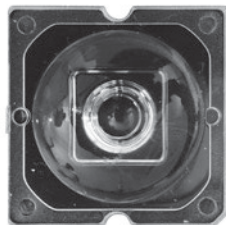
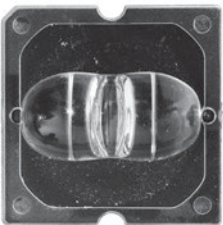

Test di funzionalità  
Test function



LED Rosso/verde  
LED Red/green

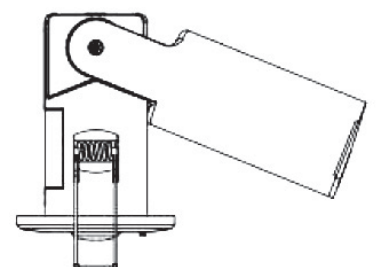
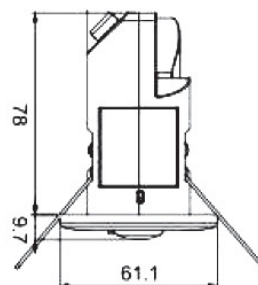



AUTOTEST

# EMERGENCY LIGHTING LUMINAIRES – LED LED SPOT EMER DALI AUTOTEST

## LED SPOT

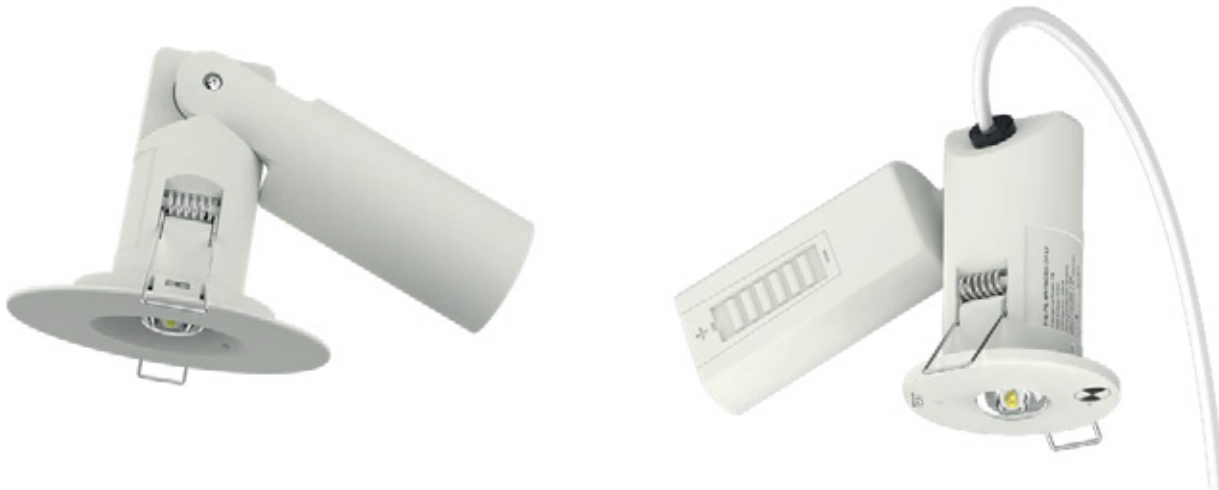

## REPLACEMENT BATTERY



BATTERIA DI RICAMBIO REPLACEMENT BATTERY		
Code	Type	Duration
RELCOBATT6.4V	6,4V 1500mAh LiFePO4	3h

## PHOTOMETRY DATA CORRIDOR LENS 3W

### Corridor Lens

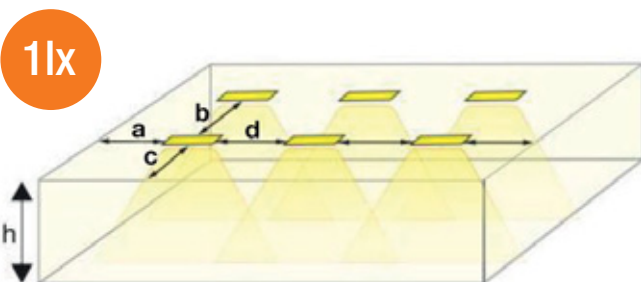

Illuminazione corridoi (per minimo 130Lm - 1 lux) (Lente asimmetrica)				
Corridor lighting (minimum 130Lm - 1 lux) (Asymmetric Lens)				
H (m)	a (m)	b (m)	c (m)	d (m)
2,80	8,15	2,72	7,3	20,05
3,00	8,3	2,69	7,5	20,05
4,00	8,8	2,35	7,5	22,8
5,00	8,8	1,8	7,0	24,2
6,00	5,3	1,3	6,0	24,9

# Open Area Lens

0,5lx

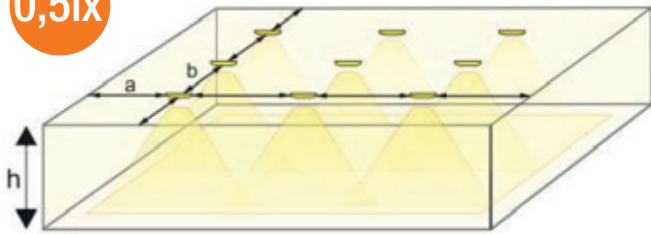

Illuminazione Area Aperta (Antipanico) (per min. 0,5 lux)  
(Lente simmetrica)

Open Area (Anti-Panic) Lighting (for min. 0,5 lux)  
(Symmetric Lens)

H (m)	a (m)	b(m)
2,80	6,2	15,5
3	6,3	16,1
4	6,5	17,2
5	6,6	17,7
6	6,5	18,1
7	6,3	18,2
8	5,8	18,1
9	5,1	17,8
10	3,9	17,2

## LIGHT DISTRIBUTION CURVE (SYMMETRIC LENS)

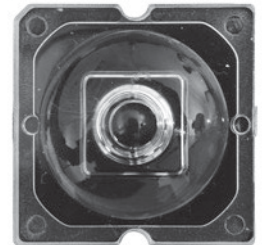
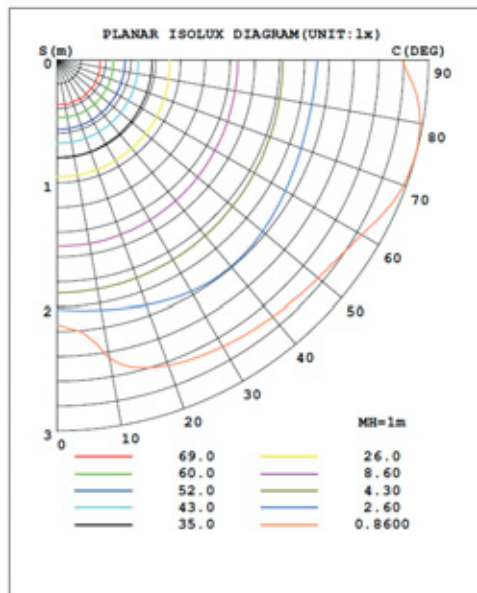
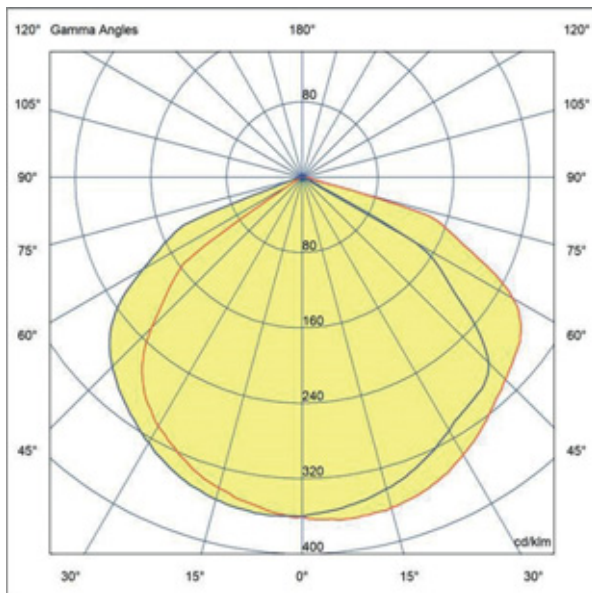

## LIGHT DISTRIBUTION CURVE (ASYMMETRIC LENS)

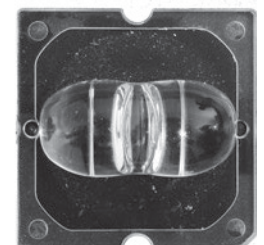
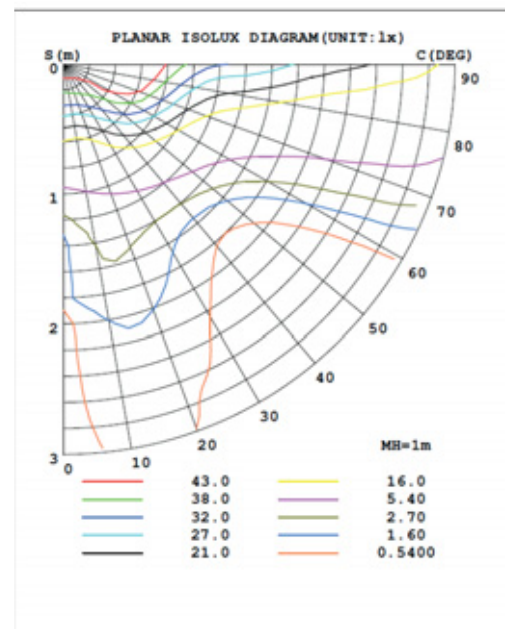
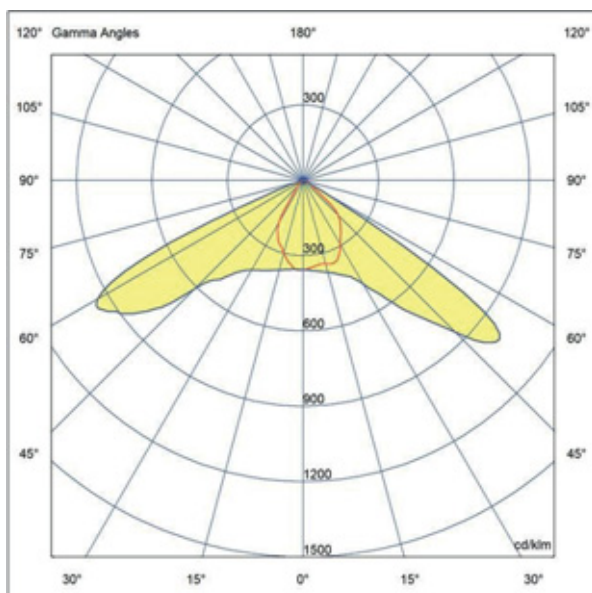

# LED Venere MyWay Bluetooth 5.0 SIG MESH

<b>Potenza*:</b>	3W (24W*)
<b>Temperatura colore:</b>	6000K
<b>Alimentazione:</b>	220-240V~, 110V~ a richiesta.
<b>Funzionamento:</b>	SA (Sempre accesa) - SE (Solo Emergenza) Rest-Mode: con dispositivo opzionale (cod. R00325).
<b>Conforme alle norme:</b>	EN60598-1; EN60598-2-2; EN60598-2-22; EN62471; EN62031; EN61347-1; EN61347-2-13.
<b>Grado di protezione:</b>	IP42 (IP65 con accessorio cod.R00310)
<b>Inibizione:</b>	vedi tabella
<b>Autonomia:</b>	1h, 2h, 3h
<b>Temperatura ambiente:</b>	-20 °C ÷ +40 °C.
<b>Installazioni:</b>	Soffitto, parete, parete a bandiera 90°, binario trifase, sospensione con tiges e cavi, incasso controsoffitto.
<b>Alimentatore:</b>	driver elettronico a corrente costante.
<b>Corpo:</b>	Polycarbonato bianco RAL 9003.
<b>Sorgente:</b>	Modulo LED
<b>Ottica:</b>	Simmetrica
<b>Schermo:</b>	Polycarbonato trasparente

\* Potenza indicativa per il confronto con tubo fluorescente (a parità di lumen prodotti).

<b>Power*:</b>	3W (24W*)
<b>Kelvin temperature:</b>	6000K
<b>Current:</b>	220-240V~, 110V~ on request.
<b>Functioning:</b>	M (Maintained) - N/M (Non-Maintained) Rest-Mode: with an optional device (code R00325).
<b>According to standard:</b>	EN60598-1; EN60598-2-2; EN60598-2-22; EN62471; EN62031; EN61347-1; EN61347-2-13.
<b>IP Degree:</b>	IP42 (IP65 with accessory cod.R00310)
<b>Inhibition:</b>	See table
<b>Autonomy:</b>	1h, 2h, 3h
<b>Operating ambient temperature:</b>	-20 °C ÷ +40 °C.
<b>Installation:</b>	Ceiling, wall, 90° flag wall, three-phase track, suspension with tiges and cables, recessed false ceiling.
<b>Driver:</b>	Electronic constant current driver.
<b>Body:</b>	White polycarbonate RAL 9003.
<b>Light source:</b>	LED module
<b>Optic:</b>	Simmetrical
<b>Shield:</b>	Transparent polycarbonate

\* Power indicative by comparison with fluorescent tube (at the same produced lumen)

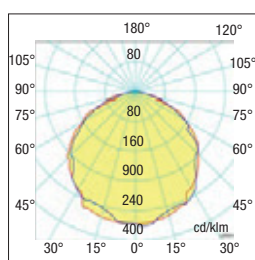
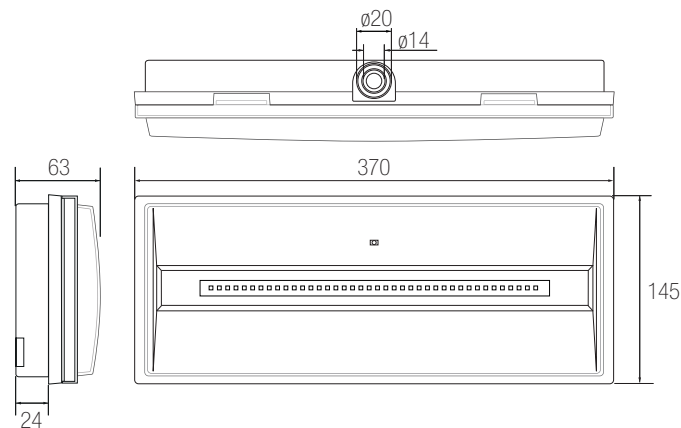

**Dati fotometrici**  
**Photometric data**

## Accessori non inclusi - Not included accessoires

da ordinare separatamente - to be ordered separately

Codice/Code	Descrizione/Description	Pag.
R00301	1 Kit Binario trifase - <i>Threephase track kit</i>	440
R00312	2 Kit IP 65	440
R00315	3 Kit controsoffitto molle e staffa - <i>Kit recessed springs and brackets</i>	440
8450S	4 Kit sospensione per bandiera - <i>Suspension kit for double sided diffuser.</i>	440
R00334	5 Scatola da incasso - <i>Built-in mounting box</i>	440
R00332	6 Cornice per incasso - <i>Flush mounting frame.</i>	440
R00342	7 Staffa 90° per bandiera - <i>90° bracket for double sided diffuser.</i>	440
R00365	8 Griglia di protezione antivandalo - <i>Anti-vandalism protection grid.</i>	440
R00325	9 Comando centralizzato per l'inibizione dell'emergenza - <i>Controller Rest-mode.</i>	440
R00322	10 5 segnali di sicurezza (adesivi) - <i>5 safety signs (adhesives).</i>	441
R00337	11 Kit segnaletica di sicurezza bifacciale (PMMA 10mm + 5 adesivi) - <i>Kit Double sided diffuser with safety signs (PMMA 10mm+ 5 adhesives).</i>	441
R00337SXDX	12 Segnaletica di sicurezza bifacciale indicazione sinistra/destra - <i>double sided indicator left/right safety signs</i>	441
R00337DIR	12 Segnaletica di sicurezza bifacciale indicazione diritto - <i>double sided indicator straight safety signs</i>	441
R00337EX	12 Segnaletica di sicurezza bifacciale indicazione (exit) - <i>double sided safety signs indicator (exit).</i>	441



# Sistema centralizzato ad interfaccia Bluetooth® Centralized system with Bluetooth® interface



## Punti di forza/ Strengths

- **Nessuna stesura di cavi e linee dedicate.**  
*No laying of cables and dedicated lines.*
- **Nessun acquisto di sistemi centralizzati e/o software.**  
*No purchase of centralized systems and/or software.*
- **Intuitivo e di facile utilizzo.**  
*Intuitive and easy to use.*
- **Necessita SOLO di collegamento elettrico L+N+T.**  
*It ONLY requires an L+N+T electrical connection.*

**LED Venere MyWay** è un apparecchio di emergenza autonomo configurabile, tramite apposita applicazione disponibile per sistema operativo Android, Apple oppure via WEB, sia in modalità sempre accesa (SA) sia in modalità solo emergenza (SE). In modalità SA la potenza massima fornita ai led è 3W. Il flusso luminoso in SA è regolabile tramite l'apposita App.

In fase di installazione è possibile scegliere l'autonomia in assenza di rete tra 1h, 1,5h, 2h oppure 3h.

È possibile associare ogni singolo dispositivo ad un gruppo di appartenenza (ad esempio piano I, oppure piano II, garage, etc.) ed associando ogni gruppo ad una centralina di supervisione (Gateway) che comunica tramite rete internet avere informazioni sul corretto funzionamento e ricevere eventuali allarmi di cattivo funzionamento tramite mail (es. batteria guasta, autonomia insufficiente etc.).

Tramite app o via WEB è possibile configurare la funzione autotest decidendo la frequenza dei test stessi.

La comunicazione tra ogni apparecchio di emergenza e il Gateway avviene tramite Bluetooth per cui la distanza massima ammessa con il Gateway è di 10 metri.

**LED Venere MyWay** is an autonomous emergency luminaire that can be configured through a special application available for the Android, Apple or WEB operating system, both in always on mode (SA) and in emergency only mode (SE). In SA mode the maximum power supplied to the LEDs is 3W. The luminous flux in SA is adjustable via the appropriate App.

During the installation phase, it is possible to choose the autonomy in the absence of the network between 1h, 1.5h, 2h or 3h.

It is possible to associate each single device to a group to which it belongs (for example floor I, or floor II, garage, etc.) and by associating each group to a supervision control unit (Gateway) which communicates via the internet network to obtain information on correct operation and to receive any malfunction alarms via e-mail (e.g. broken battery, insufficient autonomy etc.). The self-test function can be configured via the app or the WEB by deciding the frequency of the tests themselves.

The communication between each emergency device and the Gateway takes place via Bluetooth so the maximum permissible distance with the Gateway is 10 meters.

220-240 Vac	110 Vac a richiesta on demand	50/60 Hz	IP42 / IP65	IK08			850°			
-------------	-------------------------------	----------	-------------	------	--	--	------	--	--	--

## LED Venere MyWay

Descrizione Description	Potenza* Power	Versione Version	Autonomia** Autonomy	Inibizione Inhibition	Batteria Battery Ni-Cd		Ricarica Recharge	Flusso medio Average flow		n°LED	Assorb. max Absorpt. max		Pcs	Codice Code
	W		h.	APP	Volt	Ah	h.	SE lm	SA lm		SE W	SA W		
VENERE IP42 24 SA-SE 3H AT C	3W (24W*)	SE SA	1 (3)	SI	3,6	1,6	12		700	40	-	3	12	12104L40AREMW

\*Potenza indicativa per il confronto con tubo fluorescente (a parità di lumen prodotti) - Power indicative by comparison with fluorescent tube (at the same produced lumen).

\*\*Rimuovendo il Jumper interno si triplica l'autonomia e si riduce ad 1/3 il flusso luminoso - Removing the internal Jumper triples autonomy and reduces the light flow to 1/3

## Indicatori LED Autodiagnosi - LED indicator Autotest

	Fisso - Fixed light	Lampeggiante - Flashed light	
Verde - Green	Batteria carica Battery charged	Batteria in carica Battery in charge	
Rosso - Red	Lampada guasta Lamp fail	Batteria guasta e / o e autonomia insufficiente Battery fail and/or insufficient autonomy	
Arancio - Orange	Lampada inibita in assenza di rete Lamp inhibited in no mains condition	Inibizione test funzionale e di autonomia Functional and autonomy tests inhibited	

# LED Raja W-C-R Autotest

<b>Temperatura colore:</b>	6000K	<b>Kelvin temperature:</b>	6000K
<b>Alimentazione:</b>	220-240V~	<b>Current:</b>	220-240V~
<b>Funzionamento:</b>	SA (Sempre accesa) - Rest-Mode: con dispositivo opzionale (cod. R00325 pag.270).	<b>Functioning:</b>	M (Maintained) - Rest-Mode: with an optional device (code R00325 pag.270).
<b>Conforme alle norme:</b>	EN60598-1; EN60598-2-2; EN60598-2-22; EN62471; EN62031; EN61347-1; EN61347-2-13.	<b>According to standard:</b>	EN60598-1; EN60598-2-2; EN60598-2-22; EN62471; EN62031; EN61347-1; EN61347-2-13.
<b>Grado di protezione:</b>	IP40	<b>IP Degree:</b>	IP40
<b>Inibizione:</b>	Rest mode	<b>Inibition:</b>	Rest mode
<b>Autonomia:</b>	3h	<b>Autonomy:</b>	3h
<b>Temperatura ambiente:</b>	-5°C ÷ +40°C.	<b>Operating ambient temperature:</b>	-5°C ÷ +40°C.
<b>Installazioni:</b>	Soffitto, parete, parete a bandiera 90°, incasso controsoffitto.	<b>Installation:</b>	Ceiling, wall, 90° flag wall, recessed false ceiling.
<b>Alimentatore:</b>	driver elettronico a corrente costante.	<b>Driver:</b>	Electronic constant current driver.
<b>Corpo:</b>	Policarbonato bianco RAL 9003.	<b>Body:</b>	White polycarbonate RAL 9003.
<b>Sorgente:</b>	Modulo LED	<b>Light source:</b>	LED module
<b>Ottica:</b>	Simmetrica	<b>Optic:</b>	Simmetrical
<b>Schermo:</b>	PMMA trasparente	<b>Shield:</b>	Transparent PMMA



Raja W

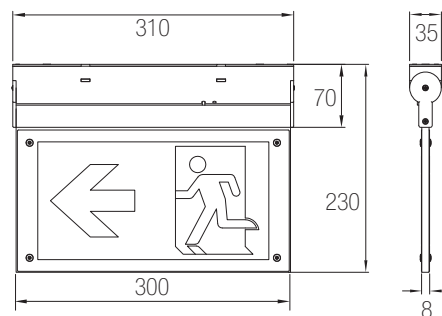

## Accessori inclusi - included accessoires

DX-DESTRA - RIGHT

SX-SINISTRA - LEFT

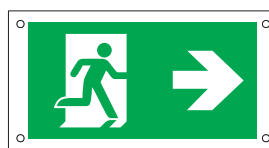

Raja C



Raja R  
+ acc. cod.8500REL/I

Accessori non inclusi - *Not included accessoires*

da ordinare separatamente - *to be ordered separately*

Codice/Code	Descrizione/Description
8500REL/U	1 Segnaletica di sicurezza bifacciale indicazione UP - <i>Safety signs UP</i>
8500REL/D	2 Segnaletica di sicurezza bifacciale indicazione DOWN - <i>Safety signs DOWN</i>
8500REL/EX	3 Segnaletica di sicurezza bifacciale indicazione EXIT - <i>Safety signs EXIT</i>
8500REL/I	4 Kit incasso controsoffitto - <i>Kit recessed plasterboard</i>
8500REL/B	5 Kit montaggio a bandiera - <i>Side mounted Kit</i>
8500REL/S	6 Kit montaggio sospensione - <i>Suspension mounted Kit</i>

Installazione ad incasso

*Recessed installation*



8500REL/D

Installazione a bandiera 90°

*90° flag installation*



8500REL/U



8500REL/B

Installazione a sospensione

*suspension installation*

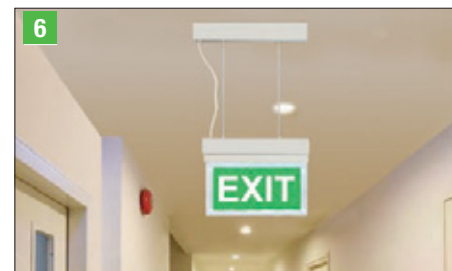

EXIT



8500REL/S

Segnaletica di sicurezza  
*Safety signs*

1 UP 8500REL/U

2 DOWN 8500REL/D

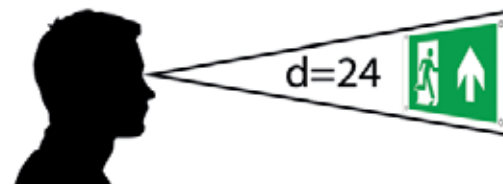

220-240 Vac	50/60 Hz	IP40	IK08			8500			
-------------	----------	------	------	--	--	------	--	--	--

LED Raja AUTOTEST

Descrizione Description	Potenza* Power W	Versione Version	Autonomia Autonomy h.	Batteria Battery Ni-Cd Volt   Ah		Ricarica Recharge h.	Flusso medio Average flow SA lm	n°LED	Assorb. max Absorpt. max SA W	Pcs	Codice Code
RAJA IP40 11 SA 3H AT	-	SA	3	3,6	0,9	24	25	16	3	10	8500REL

Indicatore LED bicolore Autodiagnosi - *bicoloured LED indicator Autotest*

	Fisso - <i>Fixed light</i>	Lampeggiante lento <i>Slow flashed light</i>	Lampeggiante veloce <i>fast flashed light</i>
Verde - <i>Green</i>	Stato tutto ok/alimentazione presente <i>Everything ok / power present</i>	Test funzionale 2 min. <i>2 minutes functional test</i>	Test di autonomia <i>Autonomy test</i>
Rosso - <i>Red</i>	Batteria guasta <i>Battery fail</i>	LED guasti <i>Faulty LEDs</i>	Durata insufficiente <i>Insufficient autonomy</i>

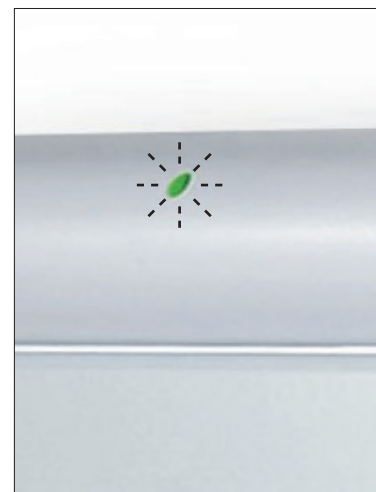

# LED Orione - in emergenza

<b>Potenza*:</b>	1W (6W*), 2W (11W*), 3W (18W*)	<b>Power*:</b>	1W (6W*), 2W (11W*), 3W (18W*)
<b>Temperatura colore:</b>	6000K	<b>Kelvin temperature:</b>	6000K
<b>Alimentazione:</b>	220-240V~	<b>Current:</b>	220-240V~
<b>Funzionamento:</b>	SA (Sempre accesa) - SE (Solo Emergenza)	<b>Functioning:</b>	M (Maintained) - N/M (Non-Maintained)
<b>Conforme alle norme:</b>	EN60598-1; EN60598-2-22; EN62471; EN62031; EN61347-1; EN61347-2-13.	<b>According to standard:</b>	EN60598-1; EN60598-2-2; EN60598-2-22; EN62471; EN62031; EN61347-1; EN61347-2-13.
<b>Grado di protezione:</b>	IP42 (IP65 optional)	<b>IP Degree:</b>	IP42 (IP65 optional)
<b>Inibizione:</b>	vedi tabella	<b>Inibition:</b>	See table
<b>Autonomia:</b>	1h, 1,5h, 2h, 3h, 5h	<b>Autonomy:</b>	1h, 1,5h, 2h, 3h, 5h
<b>Temperatura ambiente:</b>	-20 °C ÷ +40 °C.	<b>Operating ambient temperature:</b>	-20 °C ÷ +40 °C.
<b>Installazioni:</b>	Soffitto, parete, parete a bandiera 90°.	<b>Installation:</b>	Ceiling, wall, 90° flag wall.
<b>Alimentatore:</b>	driver elettronico a corrente costante.	<b>Driver:</b>	Electronic constant current driver.
<b>Corpo:</b>	Polycarbonato bianco RAL 9003.	<b>Body:</b>	White polycarbonate RAL 9003.
<b>Sorgente:</b>	Modulo LED	<b>Light source:</b>	LED module
<b>Ottica:</b>	Simmetrica	<b>Optic:</b>	Simmetrical
<b>Schermo:</b>	Polycarbonato trasparente	<b>Shield:</b>	Transparent polycarbonate

\* Potenza indicativa per il confronto con tubo fluorescente (a parità di lumen prodotti).

\* Power indicative by comparison with fluorescent tube (at the same produced lumen)

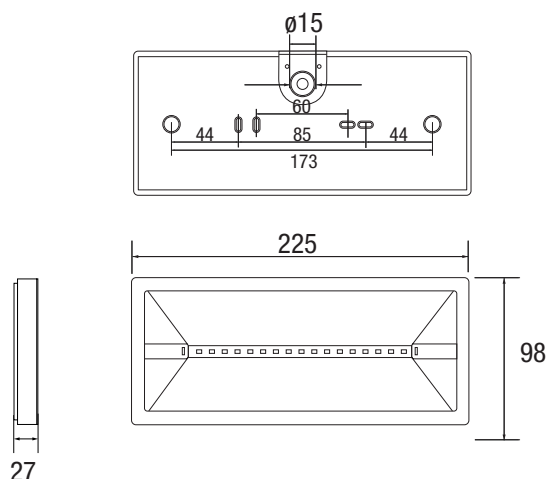
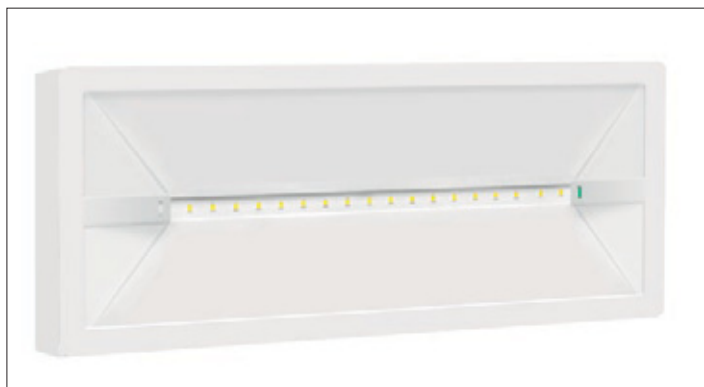

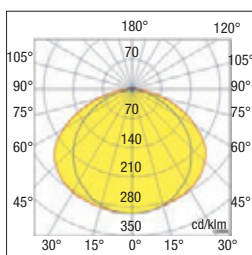

## Dati fotometrici Photometric data



## Accessori non inclusi - Not included accessoires

da ordinare separatamente - to be ordered separately

	<b>Codice batteria di ricambio Code Spare battery</b>	<b>Descrizione Description</b>	<b>Riferimento modello lampada Lamp model reference</b>
	<b>00PB1500N</b>	LiFePO <sub>4</sub> 3,2V 1,5 A	1945 1947 1948 1949
	<b>00PB060</b>	LiFePO <sub>4</sub> 3,2V 0,6 A	1946



LED Safety Lighting

Fissaggio a soffitto  
Ceilingfixing



R00338DOU

Installazione a bandiera 90°  
90° flag installation



R00338S

R00338SIG

Fissaggio a parete  
Wall fixing



R00338SIG

Fissaggio a parete con accessorio IP65  
Wall fixing with IP65 accessory

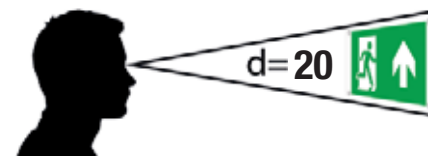

220-240 Vac    50/60 Hz    IP42 (IP65)    IK07          850°         

**LED Orione ECO**

Descrizione Description	Potenza* Power W	Versione Version	Autonomia Autonomy h.	Inibizione Inhibition switch	Batteria Life P04 Battery Life P04		Ricarica Recharge h.	Flusso medio Average flow SE lm	n° LED	Assorb. max Absorpt. max SE W	Pcs	Codice Code
					Volt	Ah						
ORIONE IP42 6 SE 1H V X	1W (6W*)	SE	5	NO	3,2	1,5	12	100	8	1,6	24	1945

**LED Orione**

Descrizione Description	Potenza* Power W	Versione Version	Autonomia** Autonomy h.	Inibizione Inhibition switch	Batteria Life P04 Battery Life P04		Ricarica Recharge h.	Flusso medio Average flow SE lm	n° LED	Assorb. max Absorpt. max SE W	Pcs	Codice Code
					Volt	Ah						
ORIONE IP42 6 SE 1H V X	1W (6W*)	SE	1 (1,5)	NO	3,2	0,6	12	150 (100)	12	1,6	24	1946
ORIONE IP42 11 SE 2H V X	2W (11W*)	SE	2 (3)	NO	3,2	1,5	24	200 (140)	12	1,6	24	1947
ORIONE IP42 18 SE 1H V X	3W (18W*)	SE	1 (2)	NO	3,2	1,5	24	320 (200)	12	1,6	24	1948

**LED Orione INHIBIT (RAPID CHARGE\*\*\*)**

Descrizione Description	Potenza* Power W	Versione Version	Autonomia** Autonomy h.	Inibizione Inhibition switch	Batteria Battery Ni-Cd		Ricarica*** Recharge h.	Flusso medio Average flow		n° LED	Assorb. max Absorpt. max		Pcs	Codice Code
					Volt	Ah		SE lm	SA lm		SE W	SA W		
ORIONE IP42 18 SA-SE 1H V I	3W (18W*)	SE SA	1 (3)	SI	3,2	1,5	6	400 (130)	180	18	3	4	24	1949

\*Potenza indicativa per il confronto con tubo fluorescente (a parità di lumen prodotti) - Power indicative by comparison with fluorescent tube (at the same produced lumen).

\*\*Rimuovendo il Jumper interno aumenta l'autonomia e si riduce il flusso luminoso - Removing the internal Jumper increases autonomy and reduces the light flow.

\*\*\*La carica completa avviene in sole 6 ore - Six hours complete recharge.

# Not included accessoires

Codice/Code	Descrizione/Description
R00338IP	1 Kit IP 65
R00338S	2 Staffa 90° per bandiera - 90° bracket for double sided diffuser.
R00338G	3 Griglia di protezione antivandalo - Anti-vandalism protection grid.
R00338SIG	4 5 segnali di sicurezza (adesivi) - 5 safety signs (adhesives).
R00338DOU	5 Kit segnaletica di sicurezza bifacciale (PC 10mm + 5 adesivi) - Kit Double sided diffuser with safety signs (PC 10mm+ 5 adhesives).

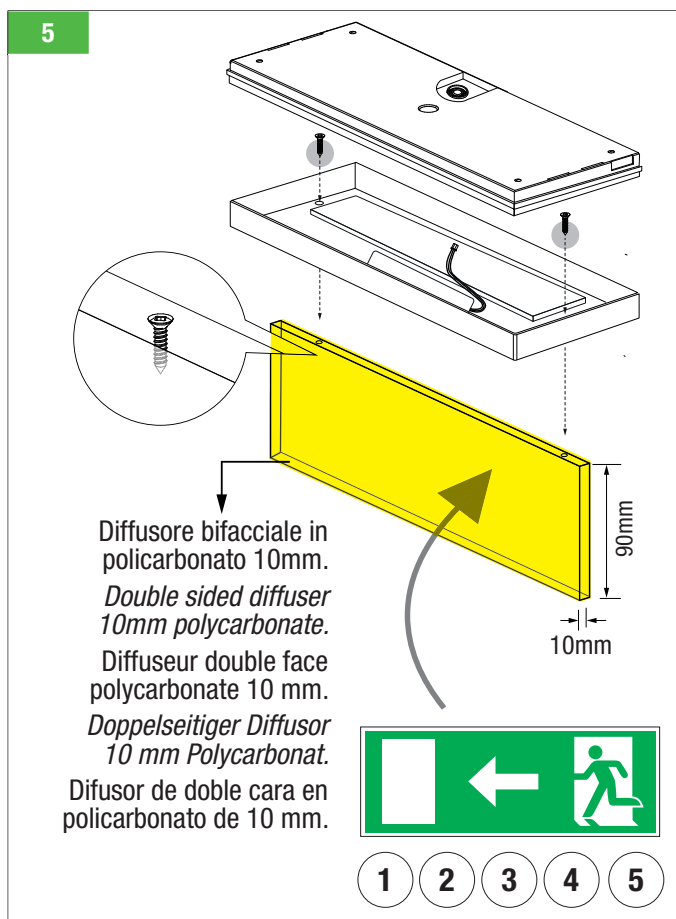
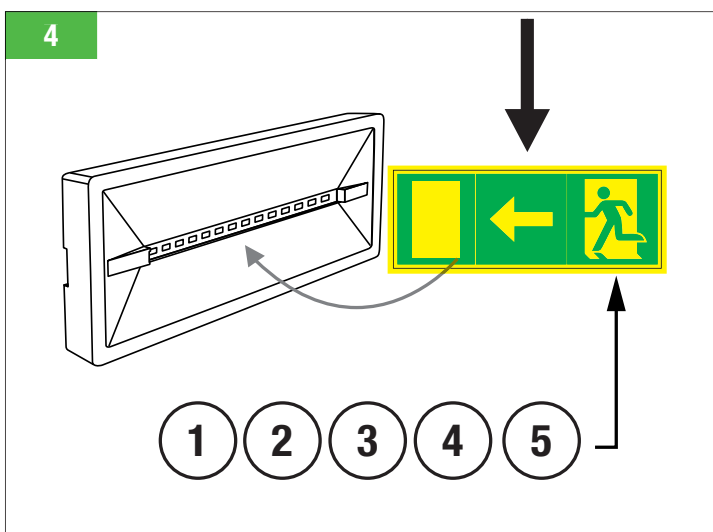
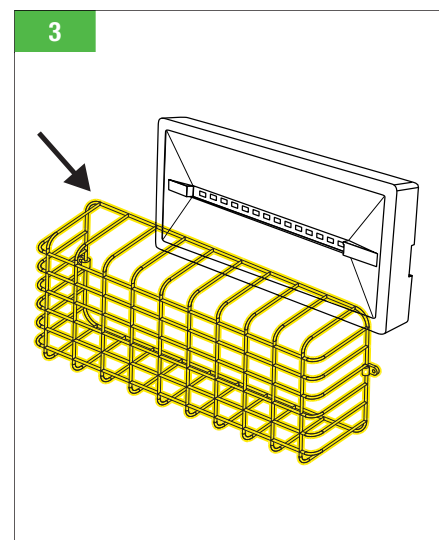
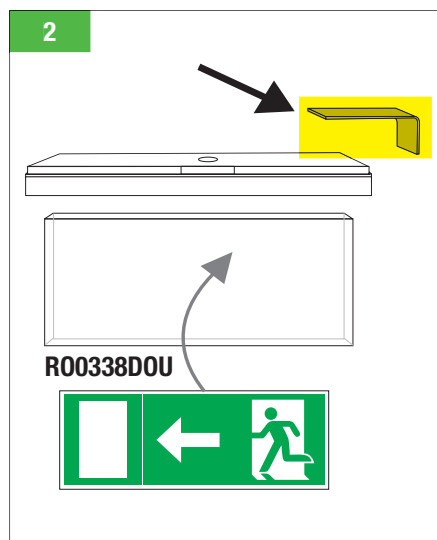
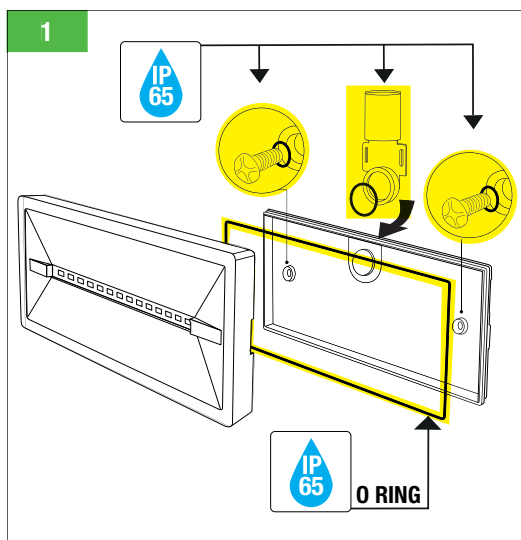

# LED Sirio

<b>Potenza*:</b>	2W (11W*) , 3W (18W*)	<b>Power*:</b>	2W (11W*) , 3W (18W*)
<b>Temperatura colore:</b>	6000K	<b>Kelvin temperature:</b>	6000K
<b>Alimentazione:</b>	220-240V~, 110V~ a richiesta.	<b>Current:</b>	220-240V~, 110V~ on request.
<b>Funzionamento:</b>	SA (Sempre accesa) - SE (Solo Emergenza) Rest-Mode: con dispositivo opzionale (cod. R00325).	<b>Functioning:</b>	M (Maintained) - N/M (Non-Maintained) Rest-Mode: with an optional device (code R00325).
<b>Conforme alle norme:</b>	EN60598-1; EN60598-2-2; EN60598-2-22; EN62471; EN62031; EN61347-1; EN61347-2-13.	<b>According to standard:</b>	EN60598-1; EN60598-2-2; EN60598-2-22; EN62471; EN62031; EN61347-1; EN61347-2-13.
<b>Grado di protezione:</b>	IP42 (IP65 con accessorio cod.R00310)	<b>IP Degree:</b>	IP42 (IP65 with accessory cod.R00310)
<b>Inibizione:</b>	vedi tabella	<b>Inhibition:</b>	See table
<b>Autonomia:</b>	1h, 2h, 3h	<b>Autonomy:</b>	1h, 2h, 3h
<b>Temperatura ambiente:</b>	-20 °C ÷ +40 °C.	<b>Operating ambient temperature:</b>	-20 °C ÷ +40 °C.
<b>Installazioni:</b>	Soffitto, parete, parete a bandiera 90°, binario trifase, sospensione con tiges e cavi, incasso controsoffitto.	<b>Installation:</b>	Ceiling, wall, 90° flag wall, three-phase track, suspension with tiges and cables, recessed false ceiling.
<b>Alimentatore:</b>	driver elettronico a corrente costante.	<b>Driver:</b>	Electronic constant current driver.
<b>Corpo:</b>	Polycarbonato bianco RAL 9003.	<b>Body:</b>	White polycarbonate RAL 9003.
<b>Sorgente:</b>	Modulo LED	<b>Light source:</b>	LED module
<b>Ottica:</b>	Simmetrica	<b>Optic:</b>	Simmetrical
<b>Schermo:</b>	Polycarbonato trasparente	<b>Shield:</b>	Transparent polycarbonate

\* Potenza indicativa per il confronto con tubo fuoescnte (a parità di lumen prodotti).

\* Power indicative by comparison with fluorescent tube (at the same produced lumen)

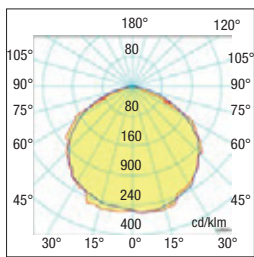
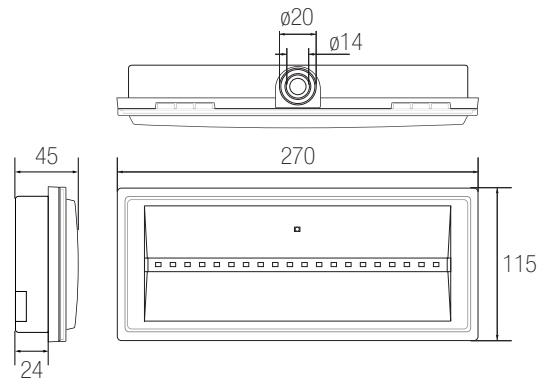

**Dati fotometrici**  
*Photometric data*

## Accessori non inclusi - *Not included accessoires*

da ordinare separatamente - *to be ordered separately*

Codice/Code	Descrizione/Description	Pag.
R00301	1 Kit Binario trifase - <i>Threephase track kit</i>	314
R00310	2 Kit IP 65	314
R00315	3 Kit controsoffitto molle e staffa - <i>Kit recessed springs and brackets</i>	314
8450S	4 Kit sospensione per bandiera - <i>Suspension kit for double sided diffuser.</i>	314
R00330	5 Scatola da incasso - <i>Built-in mounting box</i>	314
R00331	6 Cornice per incasso - <i>Flush mounting frame.</i>	314
R00342	7 Staffa 90° per bandiera - <i>90° bracket for double sided diffuser.</i>	314
R00365	8 Griglia di protezione antivandalo - <i>Anti-vandalism protection grid.</i>	314
R00325	9 Comando centralizzato per l'inibizione dell'emergenza - <i>Controller Rest-mode.</i>	314
R00320	10 5 segnali di sicurezza (adesivi) - <i>5 safety signs (adhesives).</i>	315
R00335	11 Kit segnaletica di sicurezza bifacciale (PMMA 10mm + 5 adesivi) - <i>Kit Double sided diffuser with safety signs (PMMA 10mm+ 5 adhesives).</i>	315
R00335XDX	12 Segnaletica di sicurezza bifacciale indicazione sinistra/destra - <i>double sided indicator left/right safety signs</i>	315
R00335DIR	12 Segnaletica di sicurezza bifacciale indicazione diritto - <i>double sided indicator straight safety signs</i>	315
R00335EX	12 Segnaletica di sicurezza bifacciale indicazione (exit) - <i>double sided safety signs indicator (exit).</i>	315



Fissaggio a soffitto  
Ceiling fixing



Fissaggio a parete  
Wall fixing



Installazione a bandiera 90°  
90° flag installation



Installazione su binario trifase  
three-phase track Installation



Installazione a sospensione  
Suspension installation



Installazione ad incasso con cornice  
Recessed installation with frame

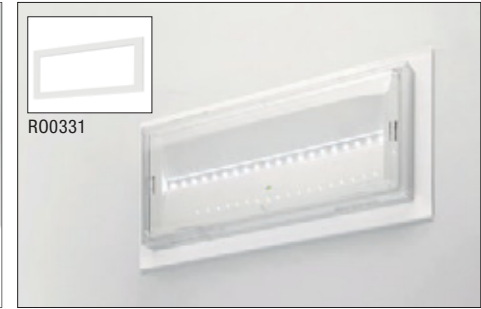

220-240 Vac    110 Vac a richiesta on demand    50/60 Hz    IP42 / IP65    IK08          850°    +40°C / -20°C      

LED Sirio ECO

Descrizione Description	Potenza* Power W	Versione Version		Autonomia** Autonomy h.	Inibizione Inhibition switch	Batteria Battery Ni-Cd		Ricarica Recharge h.	Flusso medio Average flow		n° LED	Assorb. max Absorpt. max		Pcs	Codice Code
		SE	SA			Volt	Ah		SE lm	SA lm		SE W	SA W		
SIRIO IP42 11 SE 1H V X	2W (11W*)	SE		1 (3)	NO	2,4	0,8	12	120	-	5	1,2	-	12	1956LSREL
SIRIO IP42 11 SA-SE 1H V X	2W (11W*)	SE	SA	1 (3)	NO	2,4	0,8	12	100	50	9	1,2	1,7	12	1956LSAREL
SIRIO IP42 11 SA-SE 3H V X	2W (11W*)	SE	SA	3 (9)	NO	2,4	1,6	24	100	50	9	1,2	1,7	12	1956L2SAREL

LED Sirio

Descrizione Description	Potenza* Power W	Versione Version	Autonomia** Autonomy h.	Inibizione Inhibition switch	Batteria Battery		Ricarica Recharge h.	Flusso medio Average flow		n° LED	Assorb. max Absorpt. max		Pcs	Codice Code
					Volt	Ah		SE lm	SA lm		SE W	SA W		
SIRIO IP42 11 SE 1H V I	2W (11W*)	SE	1 (3)	SI	3,6	0,8	12	150	20	20	2,7	-	12	1956L20REL
SIRIO IP42 11 SE 3H V I	2W (11W*)	SE	3 (9)	SI	3,6	1,6	24	150	20	20	2,9	-	12	1992L20REL
SIRIO IP42 18 SE 1H V I	3W (18W*)	SE	1 (3)	SI	3,2	1,5	12	400	20	20	3,5	-	12	2046LREL

LED Sirio AUTOTEST

Descrizione Description	Potenza* Power W	Versione Version	Autonomia** Autonomy h.	Inibizione Inhibition switch + rest mode	Batteria Battery Ni-Cd		Ricarica Recharge h.	Flusso medio Average flow		n° LED	Assorb. max Absorpt. max		Pcs	Codice Code	
					Volt	Ah		SE lm	SA lm		SE W	SA W			
SIRIO IP42 11 SE 1H AT C	2W (11W*)	SE	1 (3)	SI	3,6	1,6	12	160	-	20	1,6	-	12	1956L20AREL	
SIRIO IP42 11 SA-SE 3H AT C	2W (11W*)	SE	SA	1 (3)	SI	3,6	1,6	12	160	160	20	1,6	3,5	12	1992L20ASAREL

NEMKO - Certificato di sicurezza e compatibilità elettromagnetica - Safety and electromagnetic compatibility certificate.

\*Potenza indicativa per il confronto con tubo fluorescente (a parità di lumen prodotti) - Power indicative by comparison with fluorescent tube (at the same produced lumen).

\*\*Rimuovendo il Jumper interno si triplica l'autonomia e si riduce ad 1/3 il flusso luminoso - Removing the internal Jumper triples autonomy and reduces the light flow to 1/3

Indicatori LED Autodiagnosi - LED indicator Autotest

	Fisso - Fixed light	Lampeggiante - Flashed light	
Verde - Green	Batteria carica Battery charged	Batteria in carica Battery in charge	
Rosso - Red	Lampada guasta Lamp fail	Batteria guasta e / o e autonomia insufficiente Battery fail and/or insufficient autonomy	
Arancio - Orange	Lampada inibita in assenza di rete Lamp inhibited in no mains condition	Inibizione test funzionale e di autonomia Functional and autonomy tests inhibited	

# LED Venere

<b>Potenza*:</b>	3W (24W*) 5W (36W*)
<b>Temperatura colore:</b>	6000K
<b>Alimentazione:</b>	220-240V~, 110V~ a richiesta.
<b>Funzionamento:</b>	SA (Sempre accesa) - SE (Solo Emergenza) Rest-Mode: con dispositivo opzionale (cod. R00325).
<b>Conforme alle norme:</b>	EN60598-1; EN60598-2-2; EN60598-2-22; EN62471; EN62031; EN61347-1; EN61347-2-13.
<b>Grado di protezione:</b>	IP42 (IP65 con accessorio cod.R00310)
<b>Inibizione:</b>	vedi tabella
<b>Autonomia:</b>	1h, 2h, 3h
<b>Temperatura ambiente:</b>	-20 °C ÷ +40 °C.
<b>Installazioni:</b>	Soffitto, parete, parete a bandiera 90°, binario trifase, sospensione con tiges e cavi, incasso controsoffitto.
<b>Alimentatore:</b>	driver elettronico a corrente costante.
<b>Corpo:</b>	Polycarbonato bianco RAL 9003.
<b>Sorgente:</b>	Modulo LED
<b>Ottica:</b>	Simmetrica
<b>Schermo:</b>	Polycarbonato trasparente

\* Potenza indicativa per il confronto con tubo fluorescente (a parità di lumen prodotti).

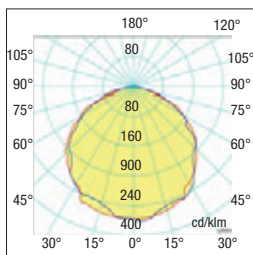

**Dati fotometrici**  
*Photometric data*

<b>Power*:</b>	3W (24W*) 5W (36W*)
<b>Kelvin temperature:</b>	6000K
<b>Current:</b>	220-240V~, 110V~ on request.
<b>Functioning:</b>	M (Maintained) - N/M (Non-Maintained) Rest-Mode: with an optional device (code R00325).
<b>According to standard:</b>	EN60598-1; EN60598-2-2; EN60598-2-22; EN62471; EN62031; EN61347-1; EN61347-2-13.
<b>IP Degree:</b>	IP42 (IP65 with accessory cod.R00310)
<b>Inhibition:</b>	See table
<b>Autonomy:</b>	1h, 2h, 3h
<b>Operating ambient temperature:</b>	-20 °C ÷ +40 °C.
<b>Installation:</b>	Ceiling, wall, 90° flag wall, three-phase track, suspension with tiges and cables, recessed false ceiling.
<b>Driver:</b>	Electronic constant current driver.
<b>Body:</b>	White polycarbonate RAL 9003.
<b>Light source:</b>	LED module
<b>Optic:</b>	Simmetrical
<b>Shield:</b>	Transparent polycarbonate

\* Power indicative by comparison with fluorescent tube (at the same produced lumen)

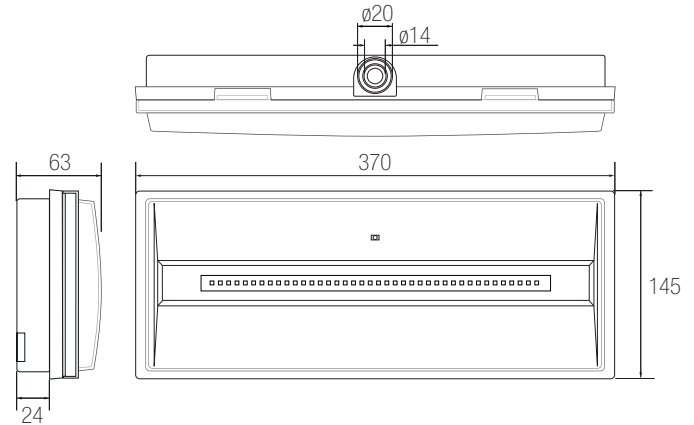

## Accessori non inclusi - *Not included accessoires*

da ordinare separatamente - *to be ordered separately*

Codice/Code	Descrizione/Description	Pag.
<b>R00301</b>	<b>1</b> Kit Binario trifase - <i>Three-phase track kit</i>	314
<b>R00312</b>	<b>2</b> Kit IP 65	314
<b>R00315</b>	<b>3</b> Kit controsoffitto molle e staffa - <i>Kit recessed springs and brackets</i>	314
<b>8450S</b>	<b>4</b> Kit sospensione per bandiera - <i>Suspension kit for double sided diffuser.</i>	314
<b>R00334</b>	<b>5</b> Scatola da incasso - <i>Built-in mounting box</i>	314
<b>R00332</b>	<b>6</b> Cornice per incasso - <i>Flush mounting frame.</i>	314
<b>R00342</b>	<b>7</b> Staffa 90° per bandiera - <i>90° bracket for double sided diffuser.</i>	314
<b>R00365</b>	<b>8</b> Griglia di protezione antivandalo - <i>Anti-vandalism protection grid.</i>	314
<b>R00325</b>	<b>9</b> Comando centralizzato per l'inibizione dell'emergenza - <i>Controller Rest-mode.</i>	314
<b>R00322</b>	<b>10</b> 5 segnali di sicurezza (adesivi) - <i>5 safety signs (adhesives).</i>	315
<b>R00337</b>	<b>11</b> Kit segnaletica di sicurezza bifacciale (PMMA 10mm + 5 adesivi) - <i>Kit Double sided diffuser with safety signs (PMMA 10mm+ 5 adhesives).</i>	315
<b>R00337SXDX</b>	<b>12</b> Segnaletica di sicurezza bifacciale indicazione sinistra/destra - <i>double sided indicator left/right safety signs</i>	315
<b>R00337DIR</b>	<b>12</b> Segnaletica di sicurezza bifacciale indicazione diritto - <i>double sided indicator straight safety signs</i>	315
<b>R00337EX</b>	<b>12</b> Segnaletica di sicurezza bifacciale indicazione (exit) - <i>double sided safety signs indicator (exit).</i>	315

Fissaggio a soffitto  
Ceiling fixing



Fissaggio a parete  
Wall fixing



Installazione a bandiera 90°  
90° flag installation



Installazione su binario trifase  
three-phase track Installation



Installazione a sospensione  
Suspension installation



Installazione ad incasso con cornice  
Recessed installation with frame



220-240 Vac 110 Vac a richiesta on demand 50/60 Hz IP42 / IP65 IK08

LED Venere

Descrizione Description	Potenza* Power W	Versione Version	Autonomia** Autonomy h.	Inibizione Inhibition switch	Batteria Battery LiFePO4 Volt Ah	Ricarica Recharge h.	Flusso medio Average flow SE lm	n°LED	Assorb. max Absorpt. max SE W	Pcs	Codice Code
VENERE IP42 24 SE 1H V I	3W (24W*)	SE	1 (3)	SI	3,2 1,6	12	320	40	2,9	10	12104L40REL
VENERE IP42 24 SE 1H V I H	3W (24W*)	SE	1	SI	3,2 3,0	12	700	40	3,2	10	12104H40REL
VENERE IP42 36 SE 1H V I H	5W (36W*)	SE	1 (2)	SI	3,2 6,0	12	1000	40	3,2	10	12104SH40REL

LED Venere AUTOTEST

Descrizione Description	Potenza* Power W	Versione Version	Autonomia** Autonomy h.	Inibizione Inhibition switch + rest mode	Batteria Battery Ni-Cd Volt Ah	Ricarica Recharge h.	Flusso medio Average flow SE lm SA lm	n°LED	Assorb. max Absorpt. max SE W SA W	Pcs	Codice Code
VENERE IP42 24 SE 1H AT C	3W (24W*)	SE	1 (3)	SI	3,6 1,6	12	320 -	40	1,6 -	10	12104L40AREL
VENERE IP42 24 SA-SE 1H AT C	3W (24W*)	SE SA	1 (3)	SI	3,6 1,6	12	320 320	40	1,6 6,0	10	12104L40ASA
VENERE IP42 24 SE 1H AT C	3W (24W*)	SE	1	SI	3,6 4	24	700	36	1,6	10	12104H40AREL

Ⓝ NEMKO - Certificato di sicurezza e compatibilità elettromagnetica - Safety and electromagnetic compatibility certificate.

\*Potenza indicativa per il confronto con tubo fluorescente (a parità di lumen prodotti) - Power indicative by comparison with fluorescent tube (at the same produced lumen).

\*\*Rimuovendo il Jumper interno si triplica l'autonomia e si riduce ad 1/3 il flusso luminoso - Removing the internal Jumper triples autonomy and reduces the light flow to 1/3

Indicatori LED Autodiagnosi - LED indicator Autotest

	☀ Fisso - Fixed light	☀ Lampeggiante - Flashed light	
Verde - Green	Batteria carica Battery charged	Batteria in carica Battery in charge	
Rosso - Red	Lampada guasta Lamp fail	Batteria guasta e / o e autonomia insufficiente Battery fail and/or insufficient autonomy	
Arancio - Orange	Lampada inibita in assenza di rete Lamp inhibited in no mains condition	Inibizione test funzionale e di autonomia Functional and autonomy tests inhibited	

# Accessori non inclusi LED Sirio- LED Venere

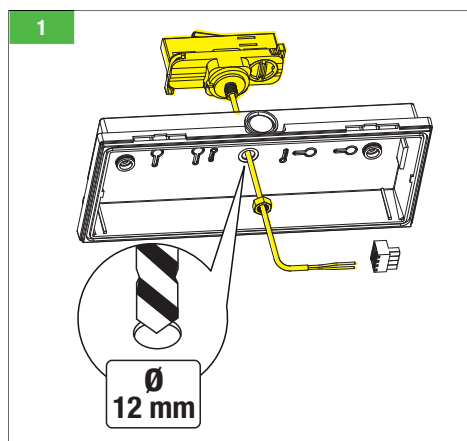

Rif.	Codice Code	Descrizione Description
SIRIO	R00301	Kit Binario trifase
VENERE		Three phase track kit

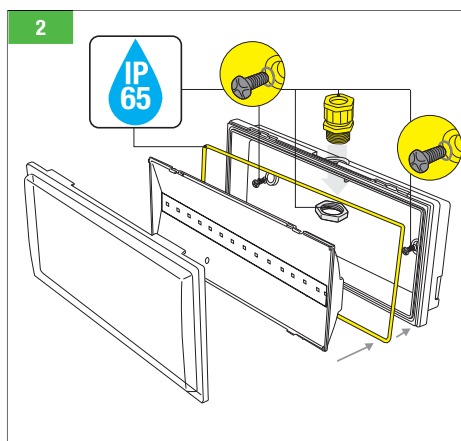

Rif.	Codice Code	Descrizione Description
SIRIO	R00310	Kit IP 65
VENERE	R00312	Kit IP 65

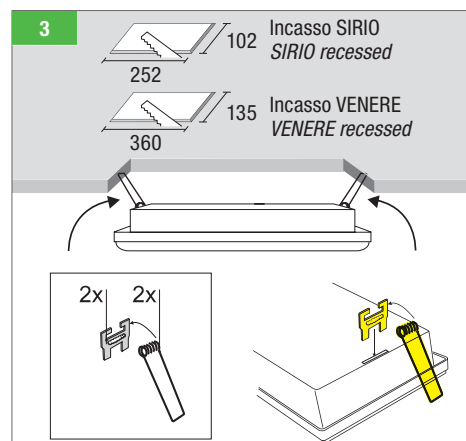

Rif.	Codice Code	Descrizione Description
SIRIO	R00315	Kit controsoffitto molle e staffa
VENERE		Kit recessed springs and brackets

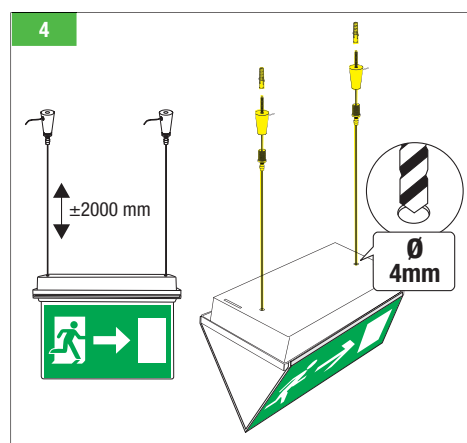

Rif.	Codice Code	Descrizione Description
SIRIO	8450S	Kit sospensione per bandiera
VENERE		Suspension kit for double sided diffuser.

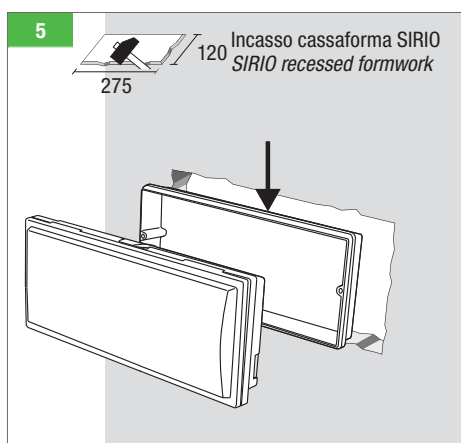

Rif.	Codice Code	Descrizione Description
SIRIO	R00330	Scatola da incasso Built-in mounting box

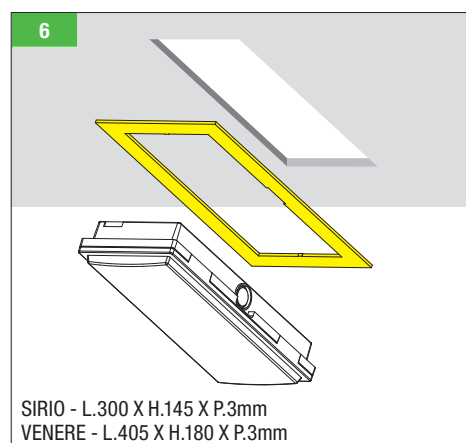

Rif.	Codice Code	Descrizione Description
SIRIO	R00331	Cornice per incasso Flush mounting frame
VENERE	R00332	Cornice per incasso Flush mounting frame

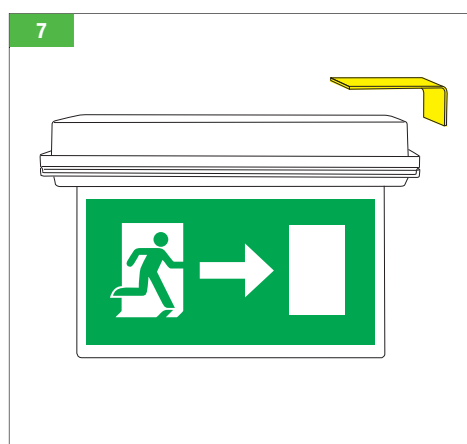

Rif.	Codice Code	Descrizione Description
SIRIO	R00342	Staffa 90° per bandiera
VENERE		90° bracket for double sided diffuser.

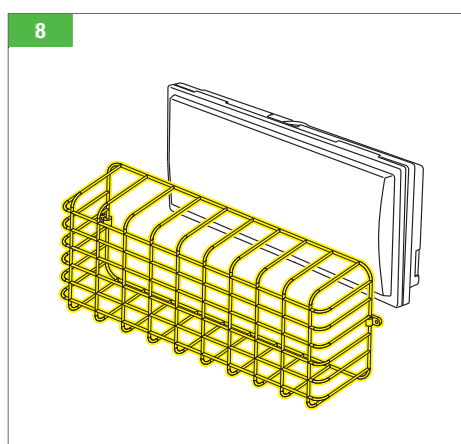

Rif.	Codice Code	Descrizione Description
SIRIO	R00365	Griglia di protezione anti-vandalo
VENERE		Anti-vandalism protection grid



Rif.	Codice Code	Descrizione Description
SIRIO	R00325	Comando centralizzato per l'inibizione dell'emergenza
VENERE		Centralized command for emergency inhibition (Controller Rest-mode)

# LED Sirio- LED Venere not included accessoires

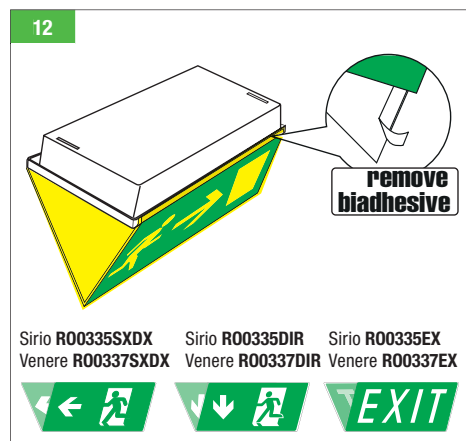
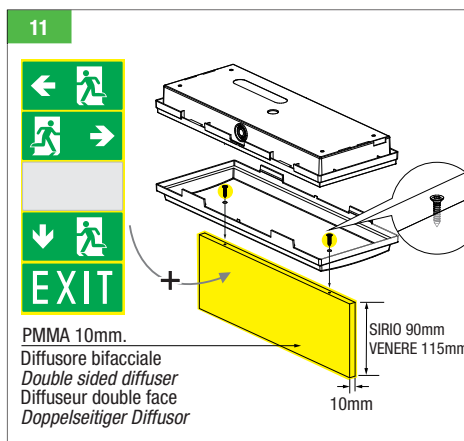
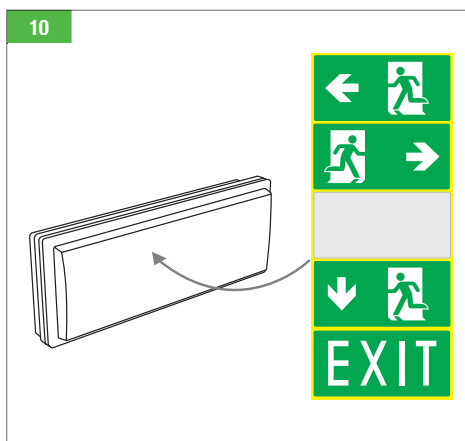

Rif.	Codice Code	Descrizione Description	DV* (m)
<b>SIRIO</b>	<b>R00320</b>	5 segnali di sicurezza adesivi	18
<b>VENERE</b>	<b>R00322</b>	5 safety signs adhesives	22

Rif.	Codice Code	Descrizione Description	DV* (m)
<b>SIRIO</b>	<b>R00335</b>	Kit Supporto PMMA e 10 segnali (adesivi)	9
<b>VENERE</b>	<b>R00337</b>	Kit PMMA support and 10 signs adhesives	11

Rif.	Codice Code	Descrizione Description	DV* (m)
<b>SIRIO</b>	<b>R00335SXD</b>	SX - DX	32
	<b>R00335DIR</b>	diritto- straight	
	<b>R00335EX</b>	exit	
<b>VENERE</b>	<b>R00337SXD</b>	SX - DX	40
	<b>R00337DIR</b>	diritto- straight	
	<b>R00337EX</b>	exit	

\*DV=Distanza di visibilità in metri - Visibility distance in meter

\*DV=Distanza di visibilità in metri - Visibility distance in meter

\*DV=Distanza di visibilità in metri - Visibility distance in meter



Segnali di sicurezza in policarbonato opalino 0,5mm. con adesivo sul retro per facilitarne l'installazione  
Opal polycarbonate safety signs 0,5mm. with adhesive on the back to facilitate installation

vedì See **10**    vedì See **11**

Adesivo segnale SX  
Adhesive sign SX

Adesivo segnale DX  
Adhesive sign DX

Adesivo segnale BASSO  
Adhesive sign BOTTOM

Adesivo segnale EXIT  
Adhesive sign EXIT

Adesivo segnale NEUTRO  
Adhesive sign NEUTRAL

Istruzioni di montaggio adesivo segnale di sicurezza  
Assembly instructions adhesive safety sign

vedì See **12**

Segnali di sicurezza in policarbonato opalino 1mm.  
Polycarbonate safety signs 1mm.

Segnale bifacciale sinistra/destra  
Double sided left/right safety signs

Segnale bifacciale dritto  
Double sided straight safety signs

Segnale bifacciale EXIT  
Double sided EXIT safety signs

LED Sirio batteria di ricambio - Spare battery			
batteria di ricambio spare battery	per Codici for Code		
<b>00PB1400</b>	1943LREL	1956LSREL	1956LSAREL
<b>00PB1600</b>	1956L2SAREL		
<b>00PB1000</b>	1956L20REL	1956L20AREL	1956L20ASAREL
<b>00PB1100</b>	1992L20REL	1956L20AREL	1992L20ASAREL

LED Venere batteria di ricambio-Spare battery			
batteria di ricambio spare battery	per Codici for Code		
<b>00PB1100</b>	12104L40REL		
<b>00PB100JST</b>	12104/3L40ASA	12104H40REL	12104L40ASAH
<b>00PB0400</b>	12104L40REL		
<b>00PB0500</b>	12104/3L40REL		



# AT Autotest

Comando centralizzato per l' inibizione dell'emergenza.  
*Centralised control to inhibit the emergency light.*

## ● CARATTERISTICHE TECNICHE

Accessorio a richiesta per inibire le lampade (solo per versioni AUTOTEST) in fase di manutenzione e verifica del corretto funzionamento dell'impianto, inoltre garantisce le operazioni di controllo che devono essere effettuate dal Responsabile della sicurezza secondo il D.Lgs 81/08 del testo unico sulla sicurezza nei luoghi di lavoro.

Il test di autonomia comprende il controllo di tutte le funzioni della lampada in un arco di tempo pari all'autonomia richiesta dalle singole normative ed è effettuato ogni 26 settimane, inoltre è previsto un test di funzionamento ogni 28 giorni, relativo a lampada, batteria e circuito.

Il risultato dei test è visualizzato da led multicolore posizionato sugli apparecchi. Questo garantisce sempre il perfetto controllo del funzionamento e consente un risparmio economico sui costi del personale altrimenti addetto alla manutenzione.

**RICARICA A CONTROLLO ELETTRONICO PER RISPARMIARE ENERGIA E RADDOPPIARE LA VITA DELLA BATTERIA**

Per ovviare allo spreco di energia causato dalla continua ricarica degli apparecchi di emergenza, Relco ha realizzato un sistema di ricarica che dopo 12 ore (ciclo completo) passa automaticamente ad una fase di autonomia per mantenere la carica contenendo l'assorbimento a meno di un Watt.

Questo sistema riduce lo spreco di energia, limita gli accumuli termici e lo stress della batteria che avrà una durata utile di circa il doppio di quanto si otterrebbe con un circuito convenzionale.

## ● TECHNICAL FEATURES

Optional accessory to inhibit lamps (only for AUTOTEST version) during maintenance and when inspecting correct operation of the system. It also guarantees the control operations which must be carried out by the Safety manager according to Leg. Decree 81/08 of the consolidated act on safety at the work place.

The autonomy test includes controlling all functions of the light within a time span equal to the autonomy required by the individual standards and is carried out every 26 weeks. An operating tests of the light, battery and circuit is also envisioned every 28 days.

The result of the test is displayed by the multi-colour LED installed on the appliances. This always ensures perfect control of operation and saves on expenses which would otherwise be required for maintenance personnel.

**ELECTRONICALLY CONTROLLED RECHARGE TO SAVE ENERGY AND TO DOUBLE THE LIFE TIME OF THE BATTERY**

To address the problem of wasting energy due to continually recharging the emergency devices, Relco has devised a recharge system which after 12 hours (complete cycle) automatically switches to the autonomy phase to hold the charge while reducing absorption to less than one Watt.

This system reduces the waste of energy, limits thermal storage and stress on the battery, approximately doubling its service life respect to that of a conventional circuit.

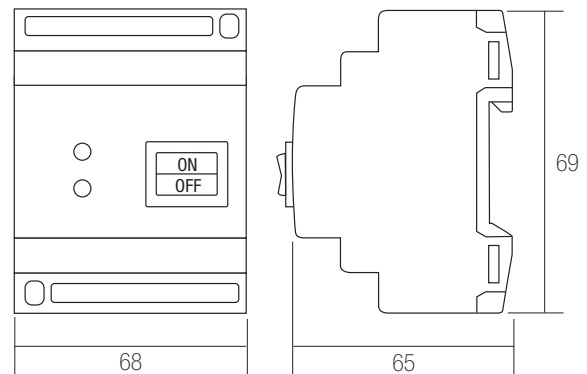

## Controller REST-MODE

Descrizione Description	Dispositivi gestibili Manageable devices	Batteria Battery	Installazione Installation	Peso weight	Imballo Pcs	Codice Code
KRM SV - 4moduli DIN	100	NiMH 3,6V 0,3Ah	Guida DIN 3,5X7,5	230 g.	10	RO0325

## Indicatori LED - LED indicator

Verde - Green	Indica la presenza di rete Showing the network presence
Rosso - Red	Indica lo stato della lampada se inibita Showing the state of the lamp if inhibited

Apparecchio autonomo d'emergenza  
Autonomous emergency device

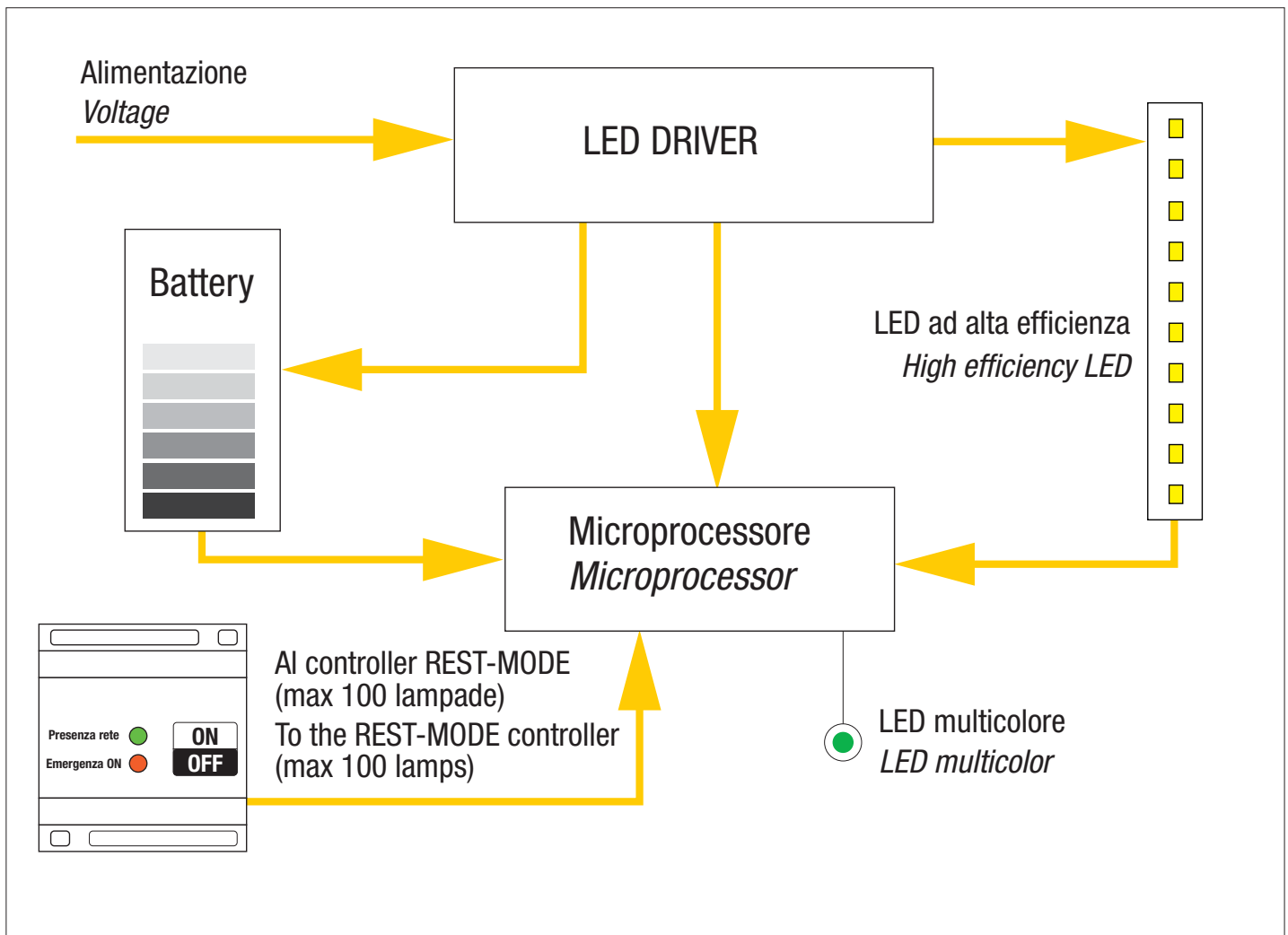

Simboli e omologazioni  
Symbols and approval

<b>W</b>	Potenza Power
<b>Lm</b>	Lumen
<b>Lm/h</b>	Lumen/Ora Lumen/Hours
<b>Battery</b>	Tipo di batteria utilizzata Type of battery used
<b>pcs</b>	Quantità minima ordinabile Minimum quantity to be ordered
<b>IP..</b>	Grado di protezione IP IP protection degree
<b>IK..</b>	Grado di protezione IK IK protection degree
	Temperatura ambiente di funzionamento Operating ambient temperature
<b>SE</b>	<b>SE (solo emergenza) o non permanente</b> La lampada si accende solo quando c'è una interruzione dell'energia elettrica che la alimenta.
<b>N/M</b>	<b>N/M (Non-Maintained)</b> The light is switch on only if there is the power supply to the light is disrupted.

<b>SA</b>	<b>SA (sempre accesa) o permanente</b> La lampada rimane costantemente accesa sia in presenza che in assenza di rete. Questo tipo di funzionamento è adatto ad illuminare un pittogramma per segnalare la via di esodo.
<b>M</b>	<b>M (Maintained)</b> The light remains on constantly if the power grid is operational or not. This type of operation is suitable for illuminating a pictogram to indicate the escape route.
	Apparecchio che resiste alla prova del filo incandescente a 850° The device passes the glow wire test at 850°.
	Apparecchio idoneo all'installazione sui mobili. The device passes the glow wire test
	Apparecchio in classe II, senza morsetto o terminale di terra. Class II device without terminal block or earth terminal
	Apparecchio per uso indipendente Independent use driver
	Apparecchio con corpo costruito con materiali riciclabili The body of this device is made of recyclable material
	Tutti i prodotti sono costruiti nel rispetto delle Normative Europee All products are manufactured in compliance with European Standards
	Sicurezza + compatibilità elettromagnetica Safety + electromagnetic compatibility



# LED SPOT EMER SE 3H AUTOTEST

<b>Potenza*:</b>	3W
<b>Alimentazione:</b>	220-240V~.
<b>Funzionamento:</b>	SE (Solo Emergenza)
<b>Conforme alle norme:</b>	EN60598-1; EN60598-2-1; EN60598-2-2; EN60598-2-22; EN62493; EN62471; EN62031; EN61347-1; EN61347-2-7; EN61347-2-13; EN55015; EN61000-3-2; EN61000-3-3; EN61547-EN1838
<b>Grado di protezione:</b>	IP20/IP40
<b>Inibizione:</b>	vedi tabella
<b>Temperatura ambiente:</b>	0-35°C
<b>Installazioni:</b>	Incasso.
<b>Corpo:</b>	Policarbonato bianco.
<b>2 Ottiche:</b>	Simmetrica - Corridoio.
<b>Schermo:</b>	Policarbonato trasparente.

<b>Power*:</b>	3W
<b>Current:</b>	220-240V~.
<b>Functioning:</b>	N/M (Non-Maintained).
<b>According to standard:</b>	EN60598-1; EN60598-2-1; EN60598-2-2; EN60598-2-22; EN62493; EN62471; EN62031; EN61347-1; EN61347-2-7; EN61347-2-13; EN55015; EN61000-3-2; EN61000-3-3; EN61547-EN1838
<b>IP Degree:</b>	IP20/IP40
<b>Inibition:</b>	See table
<b>Operating ambient temperature:</b>	0-35°C
<b>Installation:</b>	Flush mounting.
<b>Body:</b>	White polycarbonate.
<b>2 Optics:</b>	Symmetric - Corridor
<b>Shield:</b>	Transparent polycarbonate.



Apparecchiatura di sicurezza LED per l'illuminazione di vie di fuga conforme alle norme EN1838.

- LED SPOT EMER** è composto da:
- Faretto con led.
  - Alimentatore per ricarica batteria.
  - Batteria Ni-Cd 3,6V 1800mAh.
  - Due ottiche intercambiabili.

*LED safety equipment for lighting escape routes compliant with EN1838 standards.*

- SPOT EMER LED** is made up of:
- Spotlight with LED.
  - Power supply unit to recharge the battery.
  - Battery Ni-Cd 3.6V 1800mAh.
  - Two interchangeable optics.



Faretto diametro 60mm da incasso in policarbonato bianco completo di inverter per emergenza con autotest e batteria. **LED SPOT EMER** viene fornito con ottica simmetrica già montata e ottica con lente asimmetrica (corridoio). Funzionamento in SE – Non permanente: il faretto (spento normalmente), in caso di blackout si accende per 3 ore.

*Flush mounting spotlight diameter 60mm in white polycarbonate complete with emergency inverter with autotest and battery. SPOT EMER LED is supplied with pre-mounted symmetrical optics and asymmetrical lens optics (corridor). Operation in SE – Not permanent: the spotlight (normally switched off), in the event of a blackout, turns on for 3 hours.*

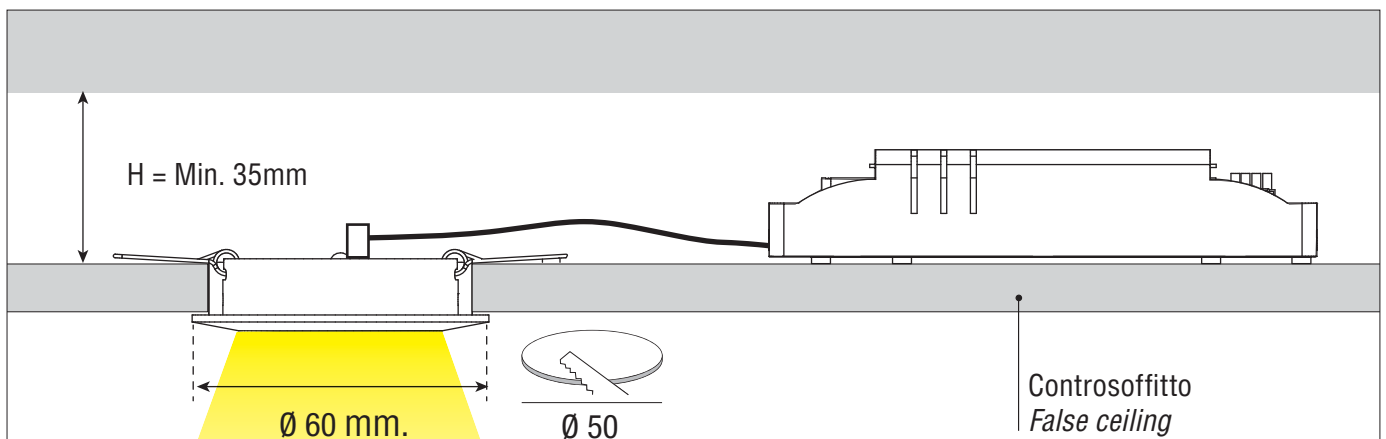





**LED SPOT EMER** con due ottiche a corredo "ottica simmetrica" e "ottica corridoi" che permette l'illuminazione ottimale delle vie di esodo.

*LED SPOT EMER with two optics supplied with "symmetrical optic" and "corridor optic" which allows optimal lighting of escape routes.*

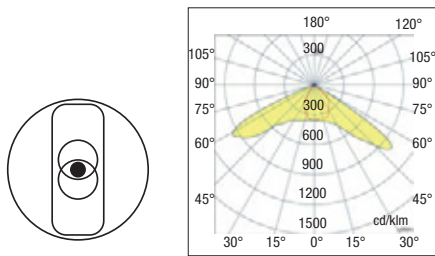

Ottica corridoi  
Corridor optic

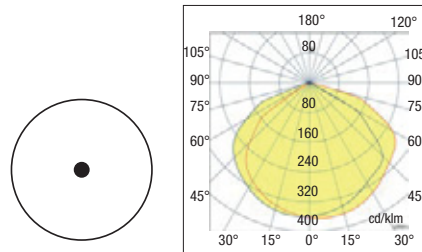

Ottica simmetrica  
Symmetric optic

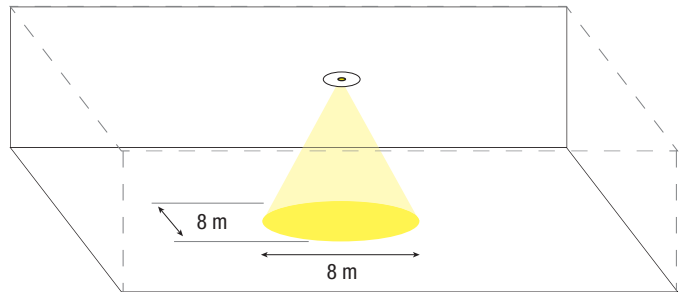
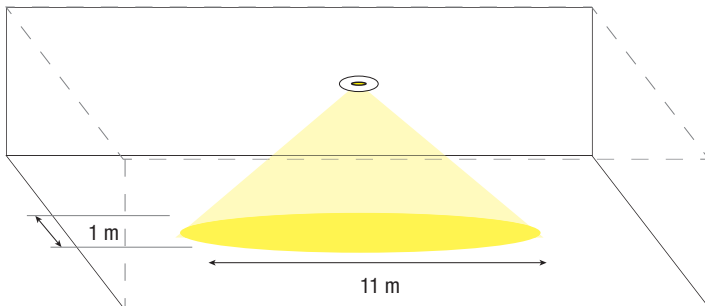

- 220-240 Vac
- 50-60 Hz
- IP20 / IP40
- IK10
- 850°
- +40°C / -20°C
- CE

**LED SPOT EMER AUTOTEST**

Descrizione Description	Potenza Power W	Versione Version	Autonomia Autonomy h.	Inibizione Inhibition switch	Batteria Battery Ni-Mh Volt	mAh	Ricarica Recharge h.	Flusso medio Average flow SE lm	n° LED	Pcs	Codice Code
SPOTEMER IP20 SE 3H AT X	3	SE	3	NO	3,6	1800	24	200	1	1	8550REL

**Indicatori LED Autodiagnosi - LED indicator Autotest**

	☀ Fisso - Fixed light	☀ 1 Lampeggio 1 Flashed light	☀ 2 Lampeggi 2 Flashed light	☀ 3 Lampeggi 3 Flashed light	LED
Verde - Green	Condizione normale / Batteria carica Normal condition / Battery full	-	-	-	LED (Green)
Rosso - Red		Batteria guasta Faulty battery	Faretto guasto Faulty spotlight	autonomia insufficiente insufficient autonomy	LED (Red)

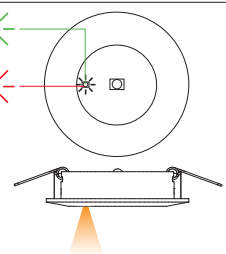

# LED Cuculo - Lampada di emergenza

<b>Potenza*:</b>	1,5W (11W*)
<b>Alimentazione:</b>	220-240V~, 110V~ a richiesta.
<b>Funzionamento:</b>	SA (Sempre accesa) - SE (Solo Emergenza)
<b>Conforme alle norme:</b>	EN60598-1; EN60598-2-2; EN60598-2-22; EN62471; EN62031; EN61347-1; EN61347-2-13.
<b>Grado di protezione:</b>	IP54
<b>Inibizione:</b>	vedi tabella
<b>Autonomia:</b>	1h, 2h
<b>Temperatura ambiente:</b>	-20 °C ÷ +40 °C.
<b>Installazioni:</b>	Soffitto, parete, binario trifase, incasso controsoffitto.
<b>Alimentatore:</b>	driver elettronico a corrente costante.
<b>Corpo:</b>	Policarbonato bianco RAL 9003.
<b>Sorgente:</b>	Modulo LED
<b>Ottica:</b>	Simmetrica
<b>Schermo:</b>	Policarbonato opale schermo alluminio antivandalo 503-54

<b>Power*:</b>	1,5W (11W*)
<b>Current:</b>	220-240V~, 110V~ on request.
<b>Functioning:</b>	M (Maintained) - N/M (Non-Maintained) .
<b>According to standard:</b>	EN60598-1; EN60598-2-2; EN60598-2-22; EN62471; EN62031; EN61347-1; EN61347-2-13.
<b>IP Degree:</b>	IP54
<b>Inhibition:</b>	See table
<b>Autonomy:</b>	1h, 2h
<b>Operating ambient temperature:</b>	-20 °C ÷ +40 °C.
<b>Installation:</b>	Ceiling, wall, three-phase track, recessed false ceiling.
<b>Driver:</b>	Electronic constant current driver.
<b>Body:</b>	White polycarbonate RAL 9003.
<b>Light source:</b>	LED module
<b>Optic:</b>	Simmetrical
<b>Shield:</b>	Opal polycarbonate Aluminium anti-vandalism protection shield 503-54

\* Potenza indicativa per il confronto con lampada di emergenza con tubo fluorescente (a parità di lumen prodotti).

\* Power indicative by comparison with emergency lamps with fluorescent tube (at the same produced lumen).

## Accessori non inclusi - Not included accessoires

da ordinare separatamente - to be ordered separately

Fig.	Descrizione/Description	Codice/Code
1	Scatola sporgente per 503 - Protuding box for 503	503BOX
2	Kit 5 segnali di sicurezza adesivi - Kit 5 safety signs adhesives	R00323

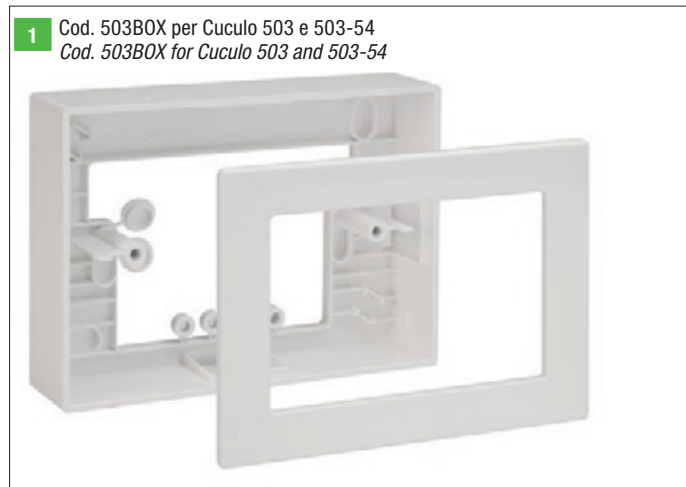

LED CUCULO 503

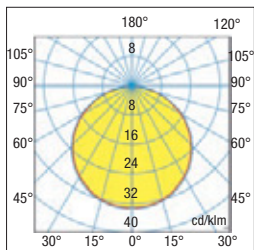
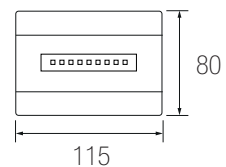

Dati fotometrici  
Photometric data



## Batteria di ricambio- Replacement battery

Fig.	Descrizione/Description	Code
4)	Batteria - Battery 2,4V - 800mAh - SE / SA	00PB1800
5)	Batteria - Battery 2,4V - 1600mAh - HSE	00PB1600





LED Cuculo 503

Incasso  
Recessed

Incasso cartongesso  
Recessed plasterboard

Cod. 503 BIN - Euro 30,00  
BOX + adaptateur triphasé  
Drei-Phasen-Adapter+BOX

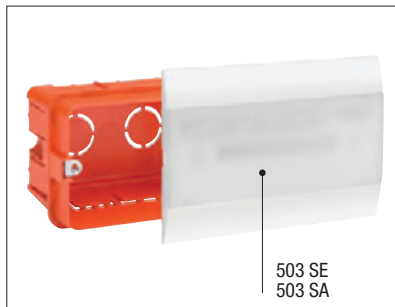

503 SE  
503 SA

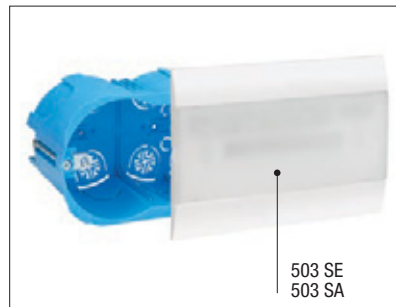

503 SE  
503 SA



503 BIN

503 SE  
503 SA

220-240 Vac	110 Vac a richiesta on demand	50/60 Hz	IP54	IK07	850°	+40°C / -20°C	CE
-------------	-------------------------------	----------	------	------	------	---------------	----

### LED Cuculo 503

Descrizione Description	Potenza* Power W	Versione Version	Autonomia** Autonomy h.	Inibizione Inhibition switch	Batteria Battery Ni-Cd		Ricarica Recharge h.	Flusso medio Average flow		n° LED	Assorb. max W		Pcs	Codice Code
					Volt	Ah		SE lm	SA lm		SE	SA		
CUCULO IP40 11 SE 1H V X	1,5W (11W*)	SE	1(3)	NO	2,4	0,8	12	120	-	5	1,7	-	10	503SE
CUCULO IP40 11 SA-SE 1H V X	1,5W (11W*)	SE SA	1(3)	NO	2,4	0,8	12	120	50	9	1,7	2,2	10	503SA

\*Potenza indicativa per il confronto con tubo fuorescente (a parità di lumen prodotti) - Power indicative by comparison with fluorescent tube (at the same produced lumen).

\*\*Rimuovendo il Jumper interno si triplica l'autonomia e si riduce ad 1/3 il flusso luminoso - Removing the internal Jumper triples autonomy and reduces the light flow to 1/3



# LED KEYEMER *Emergenza 1 modulo per scatola 503 con attacco Keystone* *Emergency 1 module for box 503 with Keystone connection*

<b>Potenza*:</b>	0,5W
<b>Alimentazione:</b>	100/220-240V~.
<b>Funzionamento:</b>	SA (Sempre accesa) - SE (Solo Emergenza)
<b>Conforme alle norme:</b>	EN60598-1; EN60598-2-2; EN60598-2-22; EN62471; EN62031.
<b>Grado di protezione:</b>	IP20
<b>Inibizione:</b>	vedi tabella
<b>Autonomia:</b>	1h, 2h
<b>Temperatura ambiente:</b>	-20°C ÷ +40°C.
<b>Installazioni:</b>	Incasso da scatola 503 con aggancio "KEYSTONE".
<b>Alimentatore:</b>	driver elettronico.
<b>Corpo:</b>	Polycarbonato trasparente.
<b>Sorgente:</b>	LED
<b>Ottica:</b>	Simmetrica.
<b>Schermo:</b>	Polycarbonato trasparente.

<b>Power*:</b>	0,5W
<b>Current:</b>	100/220-240V~.
<b>Functioning:</b>	M (Maintained) - N/M (Non-Maintained) .
<b>According to standard:</b>	EN60598-1; EN60598-2-2; EN60598-2-22; EN62471; EN62031
<b>IP Degree:</b>	IP20
<b>Inhibition:</b>	See table
<b>Autonomy:</b>	1h, 2h
<b>Operating ambient temperature:</b>	-20°C ÷ +40°C.
<b>Installation:</b>	Flush mounting from box 503 with "KEYSTONE" coupling.
<b>Driver:</b>	Electronic driver.
<b>Body:</b>	Transparent polycarbonate.
<b>Light source:</b>	LED
<b>Optic:</b>	Symmetric.
<b>Shield:</b>	Transparent polycarbonate.

**Punti di forza:**

- Compatibile con le principali serie civili mediante adattatori (inclusi).
- Prodotto da incasso con aggancio "KEYSTONE".
- Ingombro da un solo modulo.
- Funzione 2 in 1 SA (Sempre accesa) - SE (Solo Emergenza).
- Consumo <1W.

**Strengths:**

- Compatible with the main civil range using adapters (included).
- Flush mounting product with "KEYSTONE" coupling.
- Single module footprint.
- Function 2 in 1 M (Maintained) - N/M (Non-Maintained).
- Consumption <1W.

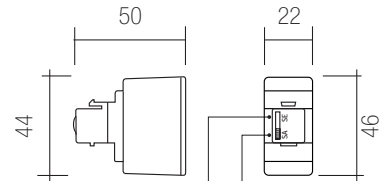

**SA** = Lampada accesa: SA (sempre accesa) in caso di black-out la luce rimane accesa.

**M** = Lamp on: M (Maintained) in case of black-out, the light remains on.

**SE** = LED verde acceso: SE (solo emergenza) funzione lampada in emergenza, si accende solo in caso di black-out.

**N/M** = LED green on: N/M (Non-Maintained), emergency luminaire function, It turns on only in case of power failure.

Dispositivo di Emergenza a LED da incasso con ingombro a un modulo, ideale per applicazioni residenziali. Installazione in serie civili Biticino o Vimar con funzione in modalità sempre accesa (segnapasso) o solo emergenza.

*LED flush mounting emergency device with one module footprint, ideal for residential applications. Installation in a Biticino or Vimar civil range functioning in always on mode (stair light) or emergency only.*

**Accessori non inclusi - Not included accessoires**

da ordinare separatamente - *to be ordered separately*

Codice/Code	Adattatore Keyemer compatibile con serie civile - Keyemer adapter compatible with civil range	
FRT05	1	BTICINO MAGIC AVORIO
FRT35	2	BTICINO LIVING NERO
FRT290	3	BTICINO AXOLUTE BIANCO
FRT200	4	BTICINO AXOLUTE HS DARK
FRT20	5	VIMAR IDEA NERO
FRT310	6	VIMAR ARKE' BIANCO



Adattatore Keyemer inclusi nella confezione  
Keyemer adapter included in the package

Compatibile con serie civile - Compatible with civil range

7	BTICINO LIVING LIGHT BIANCO
8	BTICINO LIVING LIGHT INTERNATIONAL NERO
9	BTICINO MATIX BIANCO
10	VIMAR PLANA BIANCO
11	VIMAR ARKE' NERO

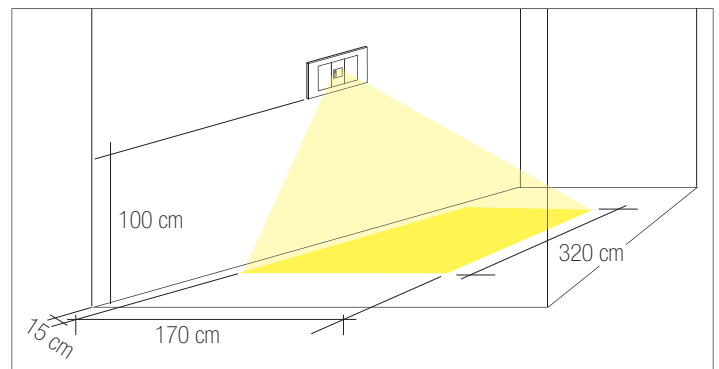
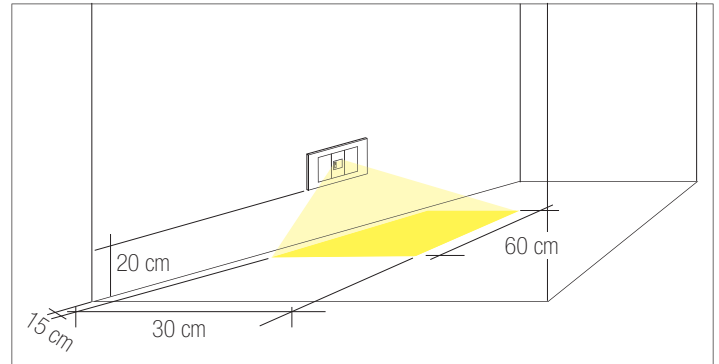

100 Vac	220-240 Vac	50-60 Hz	IP20	IK10		850°	+40 C° -20°		CE
---------	-------------	----------	------	------	--	------	----------------	--	----

LED KEYEMER												
Descrizione Description	Potenza Power W	Versione Version	Autonomia Autonomy h.	Inibizione Inhibition switch	Batteria Battery Ni-Mh Volt	Ricarica Recharge h.	Flusso medio Average flow SE lm	SA lm	n° LED	Pcs	Codice Code Code	
KEYEMER IP20 SA-SE 2H V X	0,5	SE SA	2	NO	3,6	80	8	30	5	1	1	KEI0001

## Testaletto LED



TRAVE TESTALETTO PER CAMERE DI DEGENZA DI STRUTTURE OSPEDALIERE O CASE DI CURA CON SERVIZI MULTIPLI INTEGRATI SU CANALE E VANO GAS MEDICALI. CONFORME ALLA DIRETTIVA 93/42/CE "DISPOSITIVI MEDICI"

BEDHEAD LIGHT FOR HOSPITAL OR CLINIC APPLICATION WITH INTEGRATED ELECTRICAL DEVICES AND MEDICAL GAS ARRANGEMENT IN COMPLIANCE WITH 93/42/CEE MEDICAL DEVICE DIRECTIVE

### STRUTTURA

Corpo in alluminio estruso ed anodizzato in colore naturale o verniciato in colore RAL a richiesta (spessore medio di 2,5 mm) con spigoli arrotondati. Disponibile anche in ossidazione legno naturale. Testine di chiusura in ABS grigio perla con bordi arrotondati (personalizzabili a richiesta) e fissate con una sola vite per rendere semplice la sostituzione delle lampade o qualsiasi altro intervento di manutenzione straordinaria. Completo di base fissaggio rapido a parete in acciaio zincato. Disponibile in diverse lunghezze a seconda del numero di letti presenti.

### OTTICA

Vano ottico superiore per illuminazione generale indiretta e vano ottico inferiore per luce di lettura e visita. Entrambi i vani montano lastre piane in materiale acrilico trasparente con prismi longitudinali, lisci all'esterno per una facile pulizia e passati con depolarizzante per evitare il deposito di polvere. I prismi sono inoltre orientati in modo da dare la più idonea distribuzione asimmetrica del fascio luminoso verso i piedi dell'ammalato. Riflettore interno in lamiera di acciaio verniciata in bianco.

### CABLAGGIO LED

Moduli LED ad alta efficienza 130 lm/W con IRC>90. Standard di alimentazione 230V-50Hz con driver dedicati. Cablaggio con alimentatori elettronici per lampade fluorescenti T8/T5 a richiesta. All'interno della trave vi sono due diverse canalizzazioni per 230V e per le bassissime tensioni con morsettiere situate in prossimità dell'ingresso cavi. Tutti i cablaggi fanno capo ad una o più morsettiere del tipo presa/spina.

### GAS MEDICALI

Ogni trave è dotata di uno scomparto posteriore, completamente separato dallo scomparto per i conduttori elettrici, che può contenere fino a quattro tubi per gas medicali (non inclusi).

### CONFIGURAZIONI

I servizi elettrici, i sistemi di chiamata e i vari tipi di illuminazione vengono selezionati in base alle esigenze applicative del cliente.

\* Le misure riportate sono puramente indicative. I seguenti articoli sono infatti personalizzabili a seconda delle esigenze tecniche ed estetiche del cliente.

Richiedere un preventivo.

### STRUCTURE

The body is made of steel sheet painted in RAL colour upon request (average thickness of 2,5 mm) with rounded edges. Also available in natural wood oxidation. Closing heads in pearl gray ABS with rounded edges and fixed with a single screw for an easy maintenance. Wall fixing with quick fastening steel plate. Available in different lengths according to the number of the hospital beds.

### OPTICS

Superior optical compartment for indirect lighting and lower optical compartment designed to contain light for reading and patient control. Both compartments have a PMMA diffusor with longitudinal prisms, smooth on the outside for easy cleaning and depolarized to avoid the deposit of dust. The prisms are also oriented in order to give the most appropriate asymmetric beam towards the feet of the patient. The internal reflector is made of white painted steel sheet.

### POWER LED

High efficiency LED modules 130 lm/W CRI>90. Standard 230V/50Hz with dedicated driver. Electronic ballast for fluorescent T8/T5 lamps on request. The profile has two different ducts for 230V and for very low voltages with terminal blocks located near the cable entry. All wirings are part of one or more terminals with fast connectors.

### MEDICAL GAS

Each profile is provided with a rear compartment which is completely separated from the electrical one and contain up to four medical gases tubes.

### LAYOUT

The electrical devices, call systems and various types of lighting are selected according to the customer needs.

\*The data are not binding. These products, in fact, are completely customizable according to the technical and stylist needs.

Required a quotation.

230V 50/60Hz    **IK07** **IP40**

### Testaletto 4501 LED

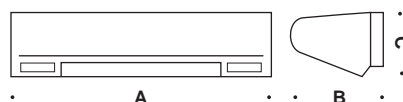

**CRI>90**



**DRIVER INCLUDED**

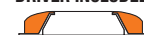

colour	Vac	lm/W	A mm	B mm.	C mm.	CELL
B	230	130	660	185	120	4501.066
B	230	130	960	185	120	4501.096
B	230	130	1300	185	120	4501.130
B	230	130	1600	185	120	4501.160

230V 50/60Hz    **IK07** **IP40**

## Testaletto 4502 LED

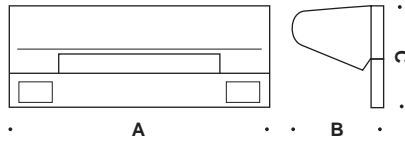

**CRI>90**



**DRIVER INCLUDED**



colour	Vac	lm/W	A mm	B mm.	C mm.	CELL
B	230	130	660	185	200	4502.066
B	230	130	960	185	200	4502.096
B	230	130	1300	185	200	4502.130
B	230	130	1600	185	200	4502.160

## Testaletto 4503 LED

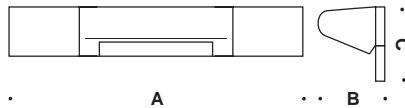

**CRI>90**



**DRIVER INCLUDED**



colour	Vac	lm/W	A mm	B mm.	C mm.	CELL
B	230	130	1600	242	300	4503.160
B	230	130	1900	242	300	4503.190
B	230	130	3500	242	300	4503.350
B	230	130	5100	242	300	4503.510

## Testaletto 4504 LED

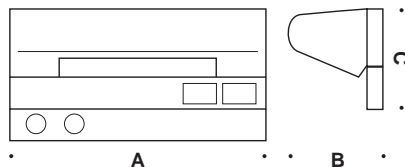

**CRI>90**



**DRIVER INCLUDED**



colour	Vac	lm/W	A mm	B mm.	C mm.	CELL
B	230	130	1600	242	300	4504.160
B	230	130	1900	242	300	4504.190
B	230	130	3500	242	300	4504.350
B	230	130	5100	242	300	4504.510

## Canale



CANALE PER TESTALETTO 4510. CON SERVIZI MULTIPLI INTEGRATI. CONFORME ALLA DIRETTIVA "93/42/CE DISPOSITIVI MEDICI"

PROFILE FOR BEDHEAD 4510 WITH INTEGRATED ELECTRICAL DEVICES IN COMPLIANCE WITH 93/42/CE MEDICAL DEVICE DIRECTIVE

### STRUTTURA

Corpo in alluminio estruso ed anodizzati in colore naturale o verniciato in colore RAL a richiesta (spessore medio di 2,5 mm) con spigoli arrotondati. Disponibile anche in ossidazione legno naturale. Testine di chiusura in alluminio con bordi arrotondati (personalizzabili a richiesta) e fissate con una sola vite per rendere semplice la sola vite per rendere semplice la sostituzione delle lampade o qualsiasi altro intervento di manutenzione straordinaria. Completo di base fissaggio rapido a parete in acciaio zincato. Disponibile in diverse lunghezze.

### CABLAGGIO

I servizi elettrici, i sistemi di chiamata e i vari tipi di illuminazione vengono selezionati in base alle esigenze applicative del cliente.

All'interno della trave vi sono due diverse canalizzazioni per 230V e per le bassissime tensioni con morsettiere situate in prossimità dell'ingresso cavi.

Tutti i cablaggi fanno capo ad una o più morsettiere del tipo presa/spina.

\* Le misure riportate sono puramente indicative. I seguenti articoli sono infatti personalizzabili a seconda delle esigenze tecniche ed estetiche del cliente.

Richiedere un preventivo.

### STRUCTURE

The body is made of steel sheet painted in RAL colour upon request (average thickness of 2,5 mm) with rounded edges. Also available in natural wood oxidation.

Closing heads in aluminium with rounded edges and fixed with a single screw for an easy maintenance. Wall fixing with quick fastening steel plate.

Available in different lengths.

### POWER

The electrical devices, call systems and various types of lighting are selected according to the customer needs.

The profile has two different ducts for 230V and for very low voltages with terminal blocks located near the cable entry.

All wirings are part of one or more terminals with fast connectors.

\*The data are not binding. These products, in fact, are completely customizable according to the technical and stylist needs.

Required a quotation.

### Canale 4510



CRI > 90



DRIVER INCLUDED

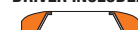

colour	Vac	A mm	B mm.	C mm.	CELL
B	230	1600	242	300	4510.160
B	230	1900	242	300	4510.190
B	230	3500	242	300	4510.350
B	230	5100	242	300	4510.510



## Clean LED

### STRUTTURA

Corpo in lamiera di acciaio spessore 0,6 mm. Cornice porta schermo con guarnizione stagna in lamiera di acciaio fissata con viti in acciaio INOX. Verniciatura a polveri epossidiche bianco RAL 9003 con trattamento anti-invecchiamento e anti-ingiallimento.

Serie 4109 adatta per l'installazione in controsoffitti con orditura a vista.

Serie 4139 adatta per l'installazione in controsoffitti con orditura nascosta.

Serie 4108 adatta per l'installazione a plafone.

Versioni da incasso equipaggiate con staffe laterali regolabili con asola per eventuale pendinatura. Versioni per controsoffitti speciali disponibili a richiesta.

### OTTICA

Diffusore in policarbonato con microprismi conici a luminanza controllata.

Luminanza media < 3.000 cd/m<sup>2</sup> per angoli >65° radiali, UGR<19.

Ottica con flusso controllato conforme alla normativa UNI EN 12464-1 e al D.Lgs. 81/2008.

Rischio fotobiologico esente (RG0).

### CABLAGGIO

Moduli LED ad alta efficienza dedicati, fattore di potenza >0,95.

Durata utile L85/B10/C0: 90.000 ore (Tp 25°C).

Temperatura colore 4.000°K, IRC (indice di resa cromatica)

>90, MacAdam SDCM 2. Versioni 3.000°K o 5.000°K disponibili a richiesta.

Standard di alimentazione 230V/50Hz con driver dedicato incluso.

### ACCESSORI

Kit Emergenza 1h (cod. 2)

Kit Emergenza 3h (cod. 3)

Kit dimmerabile 1-10V (cod. 4)

Kit dimmerabile DALI (cod. 5)

\* Le misure riportate sono puramente indicative. I seguenti articoli sono infatti personalizzabili a seconda delle esigenze tecniche ed estetiche del cliente.

**Richiedere un preventivo.**

### STRUCTURE

The body is made of steel sheet thickness 0,6mm. Steel diffuser frame with stainless screws. White powder coating RAL 9003. Waterproof gasket. Series 4109 for false ceiling with visible structure.

Series 4139 for false ceiling with hidden structure.

Series 4108 for ceiling installation.

All the recessed version are equipped with adjustable brackets with suspension hole.

Special false ceiling version available on request.

### OPTICS

Diffuser in polycarbonate with conical microprism.

Luminance with <3.000 cd/m<sup>2</sup> radial >65°, UGR<19.

Compliant to the UNI EN 12464-1 and D.Lgs. 81/2008 rules.

Photobiological safety risk exempt (RG0).

### POWER

High efficiency LED modules, power factor >0,95.

Lifetime L85/B10/C0: 90.000 ore (Tp 25°C).

Colour 4.000°K, CRI (color rendering index) >90, initial tolerance MacAdam SDCM 2.

3.000°K or 5.000°K version available on request. Power supply 230V/50Hz. LED driver included.

### ACCESSORIES

Emergency kit 1h (code 2)

Emergency kit 3h (code 3)

Dimmable 1-10V kit (code 4)

Dimmable DALI kit (code 5)

\*The data are not binding. These products, in fact, are completely customizable according to the technical and stylist needs.

**Required a quotation.**

230V 50/60Hz



IK07

IP55

### Clean LED Recessed

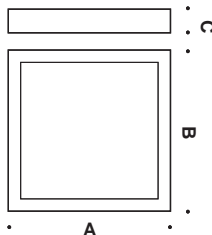

CRI>90



colour	W max	Vac	lm TC=25°C	lm output	K	A mm.	B mm.	C mm.	Kg	CELL
B	20	230	3.200	2.620	4000	295	595	90	3	4109.204
B	40	230	6.400	5.360	4000	595	595	90	3,50	4109.404
B	60	230	9.600	6.604	4000	595	595	90	3,50	4109.604
B	50	230	8.000	5.445	4000	295	1.195	90	3,90	4109.504
B	100	230	15.000	12.889	4000	595	1.195	90	5,00	4109.104
B	40	230	6.400	5.360	4000	598	598	90	3,50	4139.404
B	60	230	9.600	6.604	4000	598	598	90	3,50	4139.604
B	50	230	8.000	5.445	4000	298	1.198	90	3,90	4139.504
B	100	230	15.000	12.889	4000	598	1.198	90	5,00	4139.104

### Clean LED Plafone



colour	W max	Vac	lm TC=25°C	lm output	K	A mm.	B mm.	C mm.	Kg	CELL
B	20	230	3.200	2.620	4000	300	600	80	3,50	4108.204
B	40	230	6.400	5.360	4000	600	600	80	4	4108.404
B	60	230	9.600	6.604	4000	600	600	80	4	4108.604
B	50	230	8.000	5.445	4000	300	1.200	80	4,30	4108.504
B	100	230	15.000	12.889	4000	600	1.200	80	5,50	4108.104

## Aseptic LED

### STRUTTURA

Corpo in lamiera di acciaio spessore 0,6 mm. Cornice porta schermo con guarnizione stagna in lamiera di acciaio fissata con viti in acciaio INOX. Verniciatura a polveri epossidiche bianco RAL 9003 con trattamento anti-invecchiamento e anti-ingiallimento.

Serie 4111 adatta per l'installazione in controsoffitti con orditura a vista.

Serie 4131 adatta per l'installazione in controsoffitti con orditura nascosta.

Serie 4110 adatta per l'installazione a plafone.

Versioni da incasso equipaggiate con staffe laterali regolabili con asola per eventuale pendinatura. Versioni per controsoffitti speciali disponibili a richiesta.

### OTTICA

Diffusore in policarbonato con microprismi conici a luminanza controllata.

Luminanza media < 3.000 cd/m<sup>2</sup> per angoli >65° radiali, UGR<19.

Ottica con flusso controllato conforme alla normativa UNI EN 12464-1 e al D.Lgs. 81/2008.

Rischio fotobiologico esente (RG0).

### CABLAGGIO

Moduli LED ad alta efficienza dedicati, fattore di potenza >0,95.

Durata utile L85/B10/C0: 90.000 ore (Tp 25°C).

Temperatura colore 4.000°K, IRC (indice di resa cromatica)

>90, MacAdam SDCM 2. Versioni 3.000°K o 5.000°K disponibili a richiesta.

Standard di alimentazione 230V/50Hz con driver dedicato incluso.

### ACCESSORI

Kit Emergenza 1h (cod. 2)

Kit Emergenza 3h (cod. 3)

Kit dimmerabile 1-10V (cod. 4)

Kit dimmerabile DALI (cod. 5)

\* Le misure riportate sono puramente indicative. I seguenti articoli sono infatti personalizzabili a seconda delle esigenze tecniche ed estetiche del cliente.

Richiedere un preventivo.

### STRUCTURE

The body is made of steel sheet thickness 0,6mm. Steel diffusor frame with stainless screws. White powder coating RAL 9003. Waterproof gasket. Series 4109 for false ceiling with visible structure.

Series 4111 suitable for installation in false ceilings with exposed warping.

Series 4131 suitable for installation in false ceilings with hidden warping.

Series 4110 suitable for ceiling installation.

All the recessed version are equipped with adjustable brackets with suspension hole.

Special false ceiling version available on request.

### OPTICS

Diffusor in polycarbonate with conical microprism.

Luminance with <3.000 cd/m<sup>2</sup> radial >65°, UGR<19.

Compliant to the UNI EN 12464-1 and D.Lgs. 81/2008 rules.

Photobiological safety risk exempt (RG0).

### POWER

High efficiency LED modules, power factor >0,95.

Lifetime L85/B10/C0: 90.000 ore (Tp 25°C).

Colour 4.000°K, CRI (color rendering index) >90, initial tolerance MacAdam SDCM 2.

3.000°K or 5.000°K version available on request. Power supply 230V/50Hz. LED driver included.

### ACCESSORIES

Emergency kit 1h (code 2)

Emergency kit 3h (code 3)

Dimmable 1-10V kit (code 4)

Dimmable DALI kit (code 5)

\*The data are not binding. These products, in fact, are completely customizable according to the technical and stylist needs.

Required a quotation.

230V 50/60Hz



IK07

IP66

### Aseptic LED Recessed

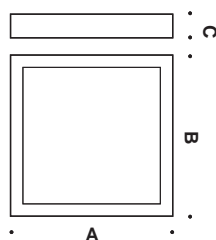

CRI>90

DRIVER INCLUDED



colour	W max	Vac	lm TC=25°C	lm output	K	A mm.	B mm.	C mm.	Kg	CELL
B	20	230	3.200	2.620	4000	295	595	90	3	4111.204
B	40	230	6.400	5.360	4000	595	595	90	3,50	4111.404
B	60	230	9.600	6.604	4000	595	595	90	3,50	4111.604
B	50	230	8.000	5.445	4000	295	1.195	90	3,90	4111.504
B	100	230	15.000	12.889	4000	595	1.195	90	5,00	4111.104
B	40	230	6.400	5.360	4000	598	598	90	3,50	4131.404
B	60	230	9.600	6.604	4000	598	598	90	3,50	4131.604
B	50	230	8.000	5.445	4000	298	1.198	90	3,90	4131.504
B	100	230	15.000	12.889	4000	598	1.198	90	5,00	4131.04

### Clean LED Plafone



colour	W max	Vac	lm TC=25°C	lm output	K	A mm.	B mm.	C mm.	Kg	CELL
B	20	230	3.200	2.620	4000	300	600	80	3,50	4110.204
B	40	230	6.400	5.360	4000	600	600	80	4	4110.404
B	60	230	9.600	6.604	4000	600	600	80	4	4110.604
B	50	230	8.000	5.445	4000	300	1.200	80	4,30	4110.504
B	100	230	15.000	12.889	4000	600	1.200	80	5,50	4110.104



# DEPURATORE

## ANTIBATTERICO - ANTIVIRALE



Un sistema efficace per abbattere il rischio di contagio in ambienti chiusi, perché la vita è nell'aria che respiriamo.

Finora abbiamo combattuto un nemico comune grazie a distanziamento, mascherine e igiene delle mani, ma ben poco abbiamo fatto per l'aria che respiriamo. DADO funziona grazie ad un sistema di filtraggio e di sanificazione a RAGGI UV-C, l'aria aspirata attraverso un sistema di ventole, viene canalizzata attraverso un filtro brevettato **FILTRO-NEXY** che grazie alla sua struttura tridimensionale non viene intasato mantenendo la sua efficacia iniziale. **Batteri** e **Virus** bloccati sul filtro vengono uccisi al **99.9%** grazie all'azione combinata UVC+FOTOCATALISI.

**L'aria così sanificata è rimessa in circolo sana in continuazione.**



### ·DADO è efficace

Consente di ridurre al 99,9%, in determinate situazioni, i rischi di infezioni causati da batteri e virus, incluso il COVID-19. In un'ora depura all'80% un ambiente di circa 30 mq. per 3 metri di altezza.

### ·DADO è sicuro

Il dispositivo può essere usato in continuo, 24 ore al giorno, anche in presenza di persone, perché non emette ozono e i raggi UVC non entrano mai in contatto con l'esterno

### ·DADO è pratico

Performance ottimali, grazie a tre diverse velocità di funzionamento. Consente di sanare gli ambienti prima dell'accesso delle persone. Azionabile da remoto tramite APP, di facile manutenzione, il filtro è lavabile (vengono dati due filtri in dotazione). La sostituzione è semplice e veloce, con utilizzo continuo di 24 ore al giorno, 7 giorni alla settimana, lavare e sostituire il filtro ogni 4 mesi.

### ·Contributi governativi

Le spese di sanificazione per gli ambienti di lavoro possono godere di contributi governativi e sostegno dell'acquisto, nella misura di crediti d'imposta o stanziamenti di fondi dedicati

In **1h**  
depura all' **80%**  
una stanza  
di circa **35mq.**  
con altezza  
**3m**



## Dado



Nasce da un progetto del Politecnico di Milano, NextMaterials, Soliani EMC e Labodesign sviluppato nell'ambito del Bando "Smart Living" di Regione Lombardia.



Nel post COVID 19 i locali pubblici (scuole, ristoranti, negozi, uffici, alberghi, ecc.) dovranno necessariamente mettere in atto interventi per diminuire i rischi di contagio.

Le tecnologie di sanificazione basate sull'utilizzo di sole lampade UVC o sull'uso dell'ozono sono scientificamente inadeguate.

Il depuratore Dado UVC Next e filtri fotocatalitici brevettati abbattano il **99,99%** di virus e batteri, bloccati sui filtri come documentato da prove certificate.

Possono essere utilizzati a parete, a soffitto o dietro le bocchette degli impianti di condizionamento senza necessità di modificare gli impianti e con possibilità di operare sia ad impianto funzionante che spento.

DADO è in grado di bloccare sui filtri batteri e virus ed altri inquinanti con una accettabile diminuzione del flusso di aria, ma soprattutto è in grado di inattivare in pochi minuti batteri e virus bloccati sui filtri.

I depuratori che utilizzano tecnologia UVC senza una efficace filtrazione sono inefficaci in quanto il tempo di irraggiamento di batteri e virus che flussano rapidamente nell'aria attraverso il dispositivo è insufficiente per disattivarli.

DADO utilizza LED UVC da 275 nm di lunga durata e basso consumo che non sviluppano ozono.

220-240V 50/60Hz     **IK07** **IP20**

## Dado



colour	W max		Area max m <sup>2</sup>	Flusso	Kg	CELL
<b>B</b>	15	Led	30	40 m <sup>3</sup> /h (50% ventola/fan) 80 m <sup>3</sup> /h (100% ventola/fan)	5.00	A_2020



**LED COLORATI**  
che consentono di visualizzare rapidamente ed in maniera completa tutte le funzioni.

Utilizza dispositivi fotocatalitici FiltriNext, brevettati da Politecnico di Milano, NextMaterials e Soliani EMC.

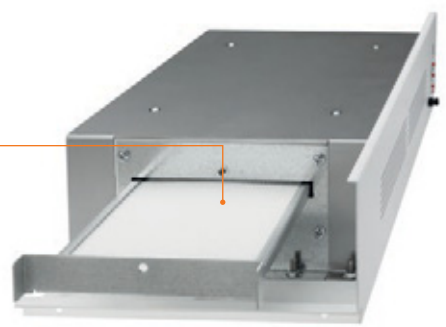

## Accessori non inclusi - Not included accessories

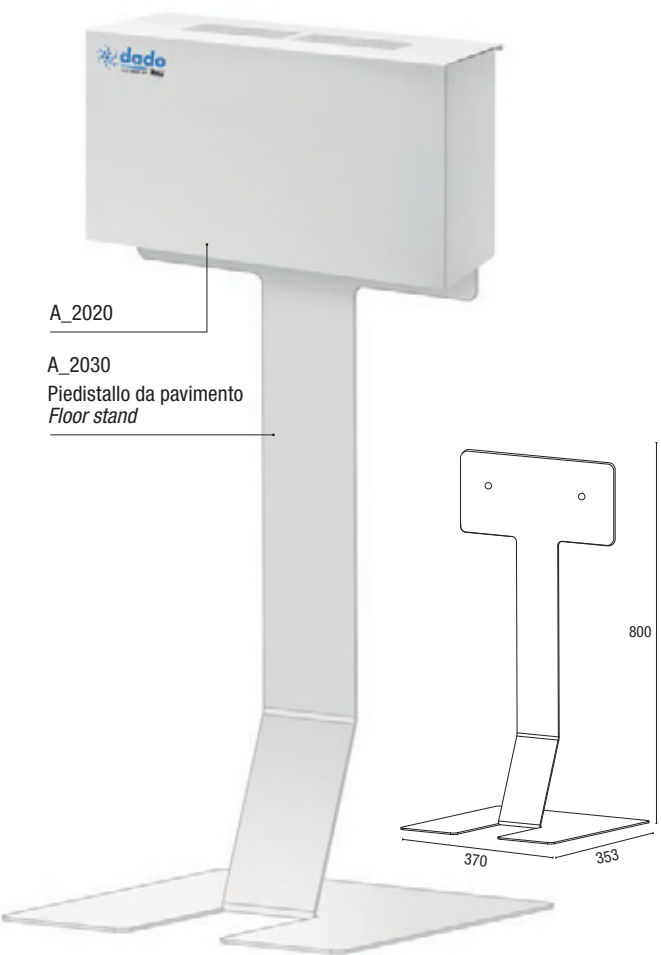

Medical Lights



Inattiva il **99,94%** dei **BATTERI** e per analogia dei **VIRUS**, bloccati sui filtri.

Con tecnologia **LED UVC** e **FILTRI FOTOCATALITICI**

Filtra fino a **80m<sup>3</sup>/h** di aria, bloccando virus e batteri sui filtri.

Medical Lights



**FILTRO FOTOCATALITICO** di **RICAMBIO** in dotazione



**TRASMETTITORE** in dotazione



**DRIVER LED A SPINA** in dotazione

SENZA FILTRO

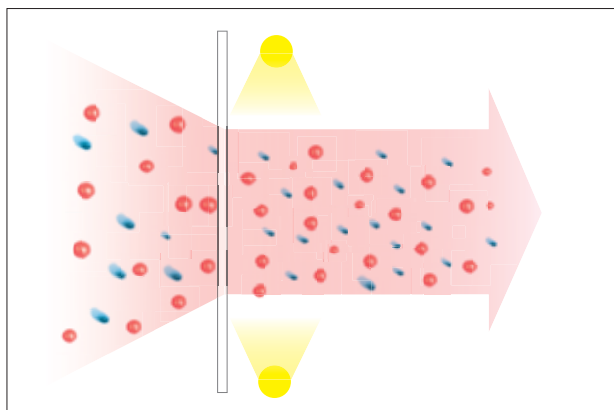

In assenza di filtro, l'aria passa davanti alla fonte di illuminazione UVC -Fotocatalisi per un tempo insufficiente ad uccidere Virus e Batteri, i dispositivi che non prevedono filtrazione sono INEFFICACI.

CON FILTRO TRADIZIONALE A TEMPO INIZIALE

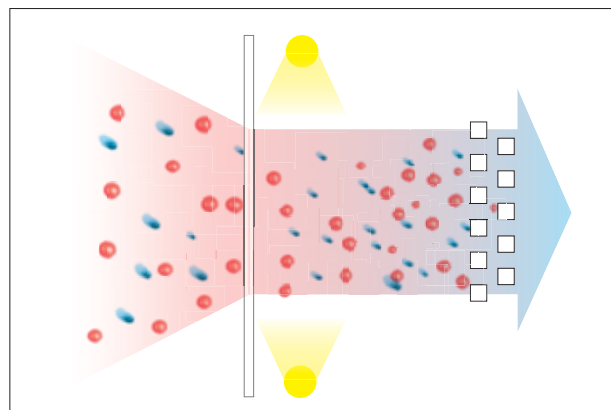

CON FILTRO TRADIZIONALE DOPO IL FUNZIONAMENTO

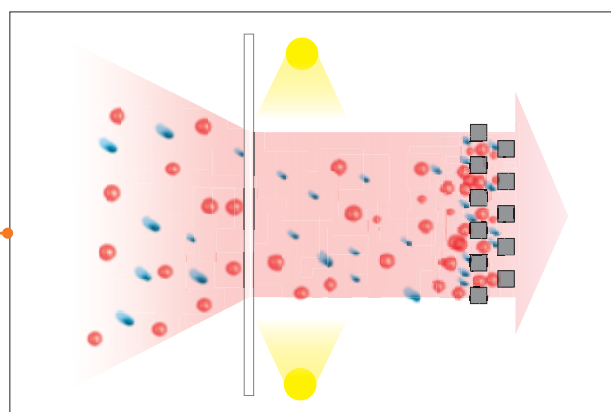

In presenza di un filtro tradizionale Virus e Batteri vengono bloccati sul filtro e uccisi in pochi minuti, ma il filtro viene rapidamente intasato, perdendo la sua capacità di filtrazione dl flusso d'aria.

CON **FILTRONEXT®** A TEMPO INIZIALE

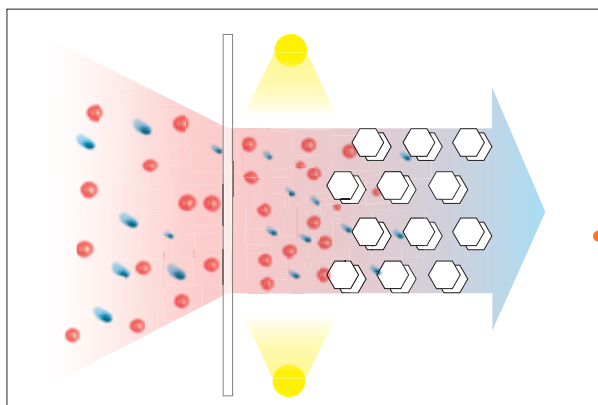

CON **FILTRONEXT®** DOPO IL FUNZIONAMENTO

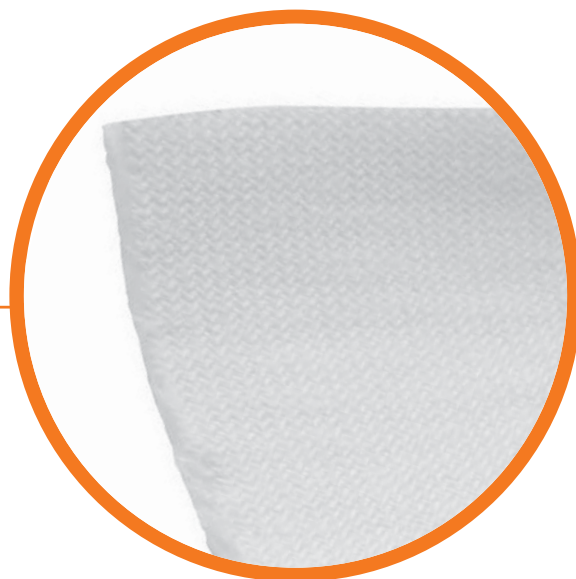
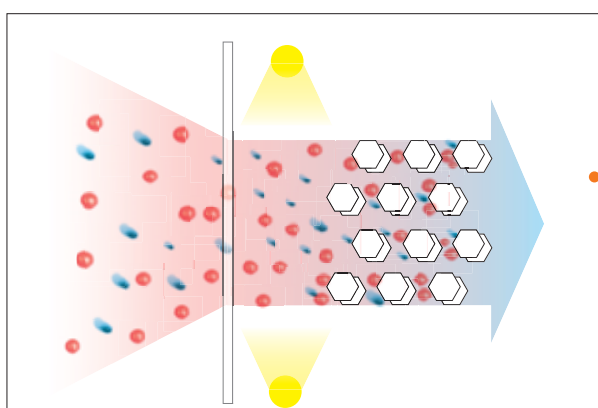

Come evidenziato dal disegno a lato, in presenza di **FILTRONEXT®** BATTERI e VIRUS vengono bloccati sul filtro e uccisi da **FILTRONEXT® UVC** + fotocatalisi, ma grazie alla sua struttura tridimensionale il filtro non viene intasato e mantiene la sua efficacia iniziale.

A seguire alcune foto del prodotto:

il prodotto viene dato con la spina per attacco alla presa, telecomando, due filtri, uno all'interno ed uno per la sostituzione quando si lava il primo. Il filtro è un filtro catalizzato TiO2 PLUS – Nickel Free brevettato. È lavabile e riutilizzabile.



**Foto 1:** Accensione prodotto con ventole al 100% della velocità (il prodotto si può accendere manualmente tramite pulsante o attraverso il telecomando).

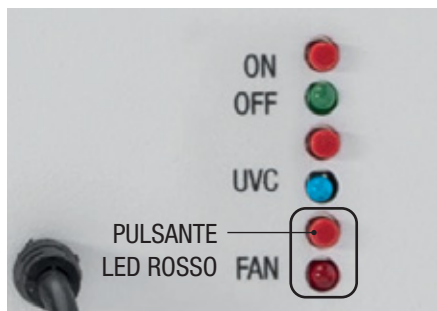

**Foto 2:** con il terzo tasto in basso si può modificare la velocità delle ventole, dal 100% al 50%, funzionamento al 50%, il Led rosso è acceso.



**Foto 3:** il secondo tasto in basso, consente di forzare l'accensione dei LED UV-C all'interno del prodotto, questa modalità si ottiene tenendolo premuto per almeno cinque secondi, il Led blu acceso indicherà la messa in funzione.

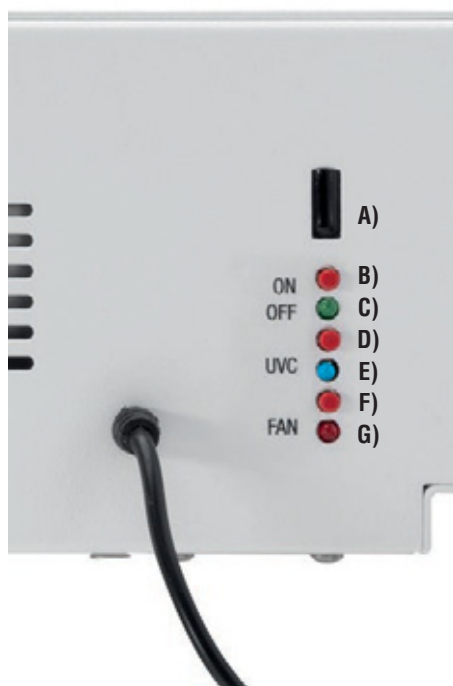

A)	Ricevitore Infrarosso, in abbinamento con trasmettitore codice: <b>Tc/RGB/N.</b>			
	Per il corretto funzionamento, non dovranno esserci ostacoli tra trasmettitore e ricevitore, portata max 10 metri.			
B)	Pulsante ON/OFF			
C)	LED verde, segnalazione accensione apparecchiatura	1	acceso	ON
		2	spento	OFF
		3	lampeggio	Sostituzione filtro
D)	Pulsante forzatura accensione Led UV-C. La scheda con led UV-C è impostata per un funzionamento automatico 1 ora ON e 3 ore OFF, tenendo premuto il pulsante per 5 sec. si forza l'accensione dei LED UV-C.			
E)	LED Blu, segnalazione scheda led UV-C.	1	acceso	ON
		2	spento	OFF
		3	lampeggio	Sostituzione scheda LED UV-C
F)	Pulsante Ventole, le ventole sono, di default, in servizio continuo al 100%, premendo il pulsante, con relativa accensione del led rosso (G), sarà possibile portare la potenza al 50%.			
G)	G) LED Rosso, segnalazione ventole.	1	acceso	50%
		2	spento	100%



**SPECIAL OFFER**

**fino ad esaurimento scorte**  
**Untill stock last**

**DRIVER INCLUDED**



NET PRICE  
**20,00 €**

**LED Semplice - Axolute trifase**  
Pag. 490



NET PRICE  
**20,00 €**

**LED Retail - Primadonna trifase**  
Pag. 491



NET PRICE  
**30,00 €**

**LED Iside**  
Pag.492



NET PRICE da  
**10,00 €**

**Hemisphere - LED Pendel Cap  
Strip LED** Pag. 493



NET PRICE da  
**20,00 €**

**LED Moon serie**  
Pag. 495



NET PRICE da  
**15,00 €**

**LED Occhio**  
Pag. 496 - 497



NET PRICE  
**20,00 €**

**LED Effect**  
Pag. 498



NET PRICE da  
**20,00 €**

**LED Galileo/LED Galileo Round**  
Pag. 499



NET PRICE da  
**30,00 €**

**LED Style**  
Pag. 500



NET PRICE da  
**4,00 €**

**LED Otto Q3**  
Pag. 501



NET PRICE da  
**10,00 €**

**LED Star serie**  
Pag. 502



NET PRICE da  
**15,00 €**

**LED Colonia**  
Pag. 503



NET PRICE  
**0,50 €**

**LED Direction - Fermasy**  
Pag. 504



NET PRICE da  
**35,00 €**

**LED Flash HL111-MR16**  
Pag. 505-506



NET PRICE da  
**20,00 €**

**LED Moon C serie**  
Pag. 507



NET PRICE da  
**4,00 €**

**LED Perth - LED Naska - 2700**  
Pag. 508



NET PRICE  
**80,00 €**

**LED Gardena**  
Pag. 509



NET PRICE da  
**5,00 €**

**LED Plafoniere LED**  
Pag. 509



NET PRICE da  
**400,00 €**

**LED Sports**  
Pag. 510



NET PRICE da  
**100,00 €**

**LED AGP**  
Pag. 512

Consegna: se non PRESENTI A STOCK entro 30gg dal ricevimento ordine per tutti i prodotti serie PROMO IN EVIDENZA.  
Delivery: if they are NOT IN STOCK within 30 days from receipt of order for all PROMO products in evidence.

Fino ad esaurimento scorte - Untill stock last

**SPECIAL OFFER**

**SPECIAL OFFER**

Quantitativo minimo **10** pezzi per cod. **Fino ad esaurimento scorte**  
 Minimum quantity **10** pieces per cod. **Untill stock last**

# LED Semplice - LED Axolute



Serie di apparecchi da binario trifase euro standard.

**Materiali:** in lega di alluminio ossidato  
**Verniciatura:** a polvere in colore Bianco RAL9010, Grigio satinato RAL9006 (LED Axolute 1 Meissa). Bianco RAL9010, Nero RAL9005 (LED Semplice 1).

**Conforme alla norma:** EN60598-1, RGO nessun rischio fotobiologico ai fini della norma EN62471.

**Led: Samsung (Axolute)** mantenimento del flusso luminoso minimo al 80%: 50.000h (L80B10).

**Led: Seoul Acriche (Semplice1)** mantenimento del flusso luminoso minimo al 80%: 50.000h (L80B10).

*Lighting series for three-phase Eurostandard tracks.*

**Materials:** oxidized aluminum

**Coating:** in powder coated RAL9010 White, RAL9006 Grey (LED Axolute 1 Meissa).

RAL9010 White, RAL9005 Black (LED Semplice 1).

**According to standard:** EN60598-1, RGO exempt from photo-biological risks in compliance with standard EN62471.

**Led: Samsung(Axolute)** maintenance of minimum luminous flux to 80%: 50.000h (L80B10).

**Led: Seoul Acriche (Semplice1)** maintenance of minimum luminous flux to 80%: 50.000h (L80B10).

220-240V 50/60Hz



**CRI >80**

## LED Semplice 1

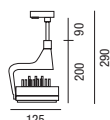

colour	W	△	K	Lm	pcs	Kg	CELL	Q.tà	Euro	NET PRICE
<b>B</b>	17	95°	4000	1520	001	0.72	31281	489	143,00	<b>PROMO € 20,00</b>
<b>N</b>	17	95°	4000	1520	001	0.72	31283	749	143,00	

## LED Axolute 1 Meissa

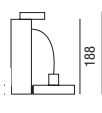

colour	W	△	lm	K	pcs	Kg	CELL	Q.tà	Euro	NET PRICE
<b>G</b>	21	40°	2000	3000	001	2.30	32518	350	157,00	<b>PROMO € 20,00</b>
<b>B</b>	21	40°	2000	3000	001	2.30	32519	350	157,00	
<b>B</b>	24	40°	1800	3000	001	2.30	32491	300	157,00	

**SPECIAL OFFER** Quantitativo minimo **10** pezzi per cod. **Fino ad esaurimento scorte**  
**Minimum quantity 10 pieces per cod. Untill stock last**

# LED Retail

220-240V 50/60Hz **IK07** **IP20**

## LED Retail trifase U-BOOT

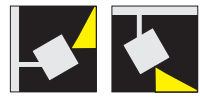
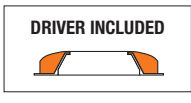
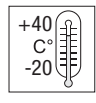

colour	W	lm output	K	Beam	pcs	Kg	CELL	Q.tà	NET PRICE
B	30	3000	3000	25°	001	1,30	32555	1000	<b>PROMO</b> <b>€ 20,00</b>
B	30	3000	3000	40°	001	1,30	3255540	1000	
B	30	3000	4000	25°	001	1,30	325554K	1000	
B	30	3000	4000	40°	001	1,30	325554K40	1000	
<b>DALI 2</b> B	30	3000	3000	25°	001	1,30	32555DA	1000	<b>PROMO</b> <b>€ 30,00</b>
<b>DALI 2</b> B	30	3000	3000	40°	001	1,30	32555DA40	1000	
<b>DALI 2</b> B	30	3000	4000	25°	001	1,30	325554KDA	1000	
<b>DALI 2</b> B	30	3000	4000	40°	001	1,30	325554KDA40	1000	

## LED Retail plafone



colour	W	lm output	K	Beam	pcs	Kg	CELL	Q.tà	NET PRICE
G	30	3000	3000	40°	001	1,30	32478	50	<b>PROMO</b> <b>€ 20,00</b>

### Dati fotometrici - Photometric data

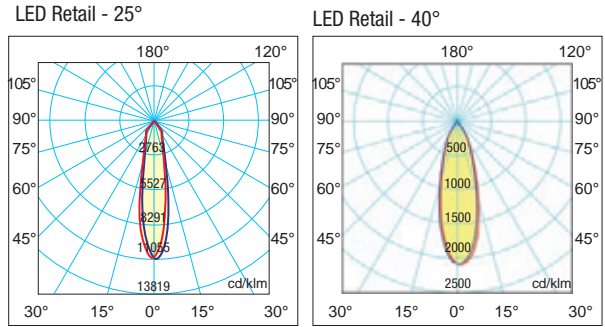

# LED Primadonna

220-240V 50/60Hz **IK07** **IP20**

## LED Primadonna 20W Bianco/White

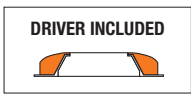
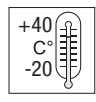

colour	W	lm output	K	Beam	pcs	Kg	CELL	Q.tà PCS	Euro netto
B	20	2000	3000	40°	001	1,20	32920/20	300	<b>20,00</b>
B	20	2000	3000	24°	001	1,20	32921/20	300	

### LED Primadonna - 20°

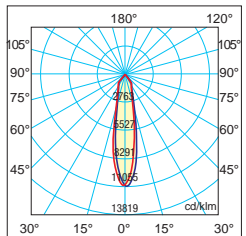

Quantitativo minimo **10** pezzi per cod. **Fino ad esaurimento scorte** - Minimum quantity **10** pieces per cod. **Untill stock last**

**SPECIAL OFFER**

Quantitativo minimo 10 pezzi per cod. Fino ad esaurimento scorte - Minimum quantity 10 pieces per cod. Untill stock last

**SPECIAL OFFER**

Quantitativo minimo **10** pezzi per cod. **Fino ad esaurimento scorte**  
 Minimum quantity **10** pieces per cod. **Untill stock last**

# LED Iside



Serie di proiettori a sospensione con elevata resa cromatica per utilizzo in centri commerciali, supermercati per mettere in risalto i banchi di alimentari, uffici o spazi in coworking, concessionari e grandi aree in genere.

**Corpo:** vano porta componenti in alluminio pressofuso, verniciato a polveri poliesteri resistente alla corrosione ed agli agenti atmosferici. Dissipatore in lega di alluminio estruso. Piastra porta cablaggio in acciaio.

**Diffusore:** in policarbonato trasparente internamente prismaticizzato e all'esterno liscio antipolvere per una rapida pulizia, infrangibile e autoestinguente V2.

**Conforme alla norma:** EN60598-1, RG0 nessun rischio fotobiologico ai fini della norma EN62471.

**Led:** mantenimento del flusso luminoso minimo al 80%: 50.000h (L80B10).

**Driver:** Incluso > 50.000 h Fattore di potenza ≥0,95.

*Series of suspension projectors with high color rendering for use in shopping centers, supermarkets to highlight food counters, offices or coworking spaces, dealers and large areas in general.*

***Body:** component housing in die-cast aluminum, painted with polyester powder paint resistant to corrosion and atmospheric agents. Heat sink in extruded aluminum alloy. Steel wiring plate.*

***Diffuser:** internally prismatic transparent polycarbonate and smooth dust-proof exterior for quick cleaning, unbreakable and self-extinguishing V2.*

***Conforms to the standard:** EN60598-1, RG0 no photobiological risk for the purposes of the EN62471 standard.*

***Led:** maintenance of the minimum luminous flux at 80%: 50.000h (L80B10).*

***Driver:** Included > 50,000 h Power factor ≥0.95.*

## LED Iside 1 - LED Iside 2

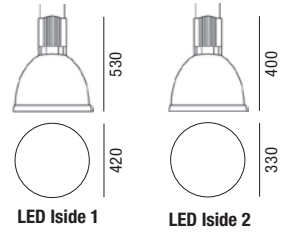

	colour	W	△	Lm output	K	pcs	Kg	CELL	Q.tà	Euro	NET PRICE
LED Iside 1	B	21	60°	2170	3000	001	2,80	30805/LED	272	180,00	<b>PROMO € 30,00</b>
	G	21	60°	2170	3000	001	2,80	30803/LED	273	180,00	
LED Iside 2	B	21	60°	2170	3000	001	2,80	30797/LED	52	180,00	
	G	21	60°	2170	3000	001	2,80	30795/LED	52	180,00	

A richiesta: versione 4000K - **On demand:** 4000K versions

## LED Iside 3

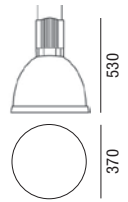

	colour	W	△	Lm output	K	pcs	Kg	CELL	Q.tà	Euro	NET PRICE
	G	21	60°	2170	3000	001	2.80	30823/LED	98	180,00	<b>PROMO € 30,00</b>

A richiesta: versione 4000K - **On demand:** 4000K versions

**SPECIAL OFFER**

# Hemisphere - Pendel Cap LED - LED Flex

## Hemisphere 340 - Hemisphere 500

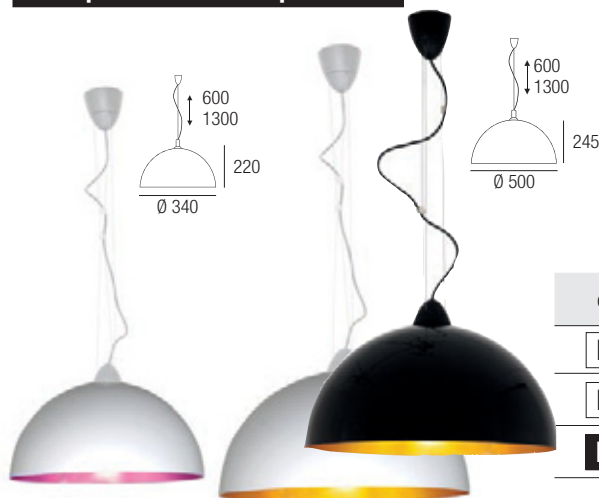

220-240V 50/60Hz **IK07** **IP20**

colour	Source	Kg	Ø	S	Q.tà	Euro	NET PRICE
B	E27	2.00	340	5716	34	100,00	<b>PROMO € 20,00</b>
B	E27	2.50	500	4842	12	170,00	
N	E27	2.50	500	4844	12	170,00	

## Pendel Cap LED

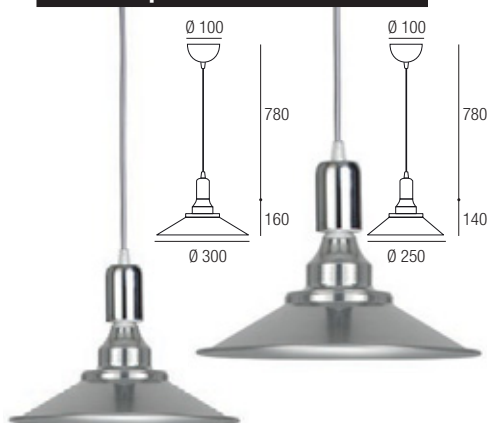

colour	W	Lm output	K	Ø	S	Q.tà	Euro	NET PRICE
G	25	2250	3000	250	VLH/B/25	60	20,00	<b>PROMO € 10,00</b>
G	30	2700	3000	300	VLH/B/30	38	25,00	

## LED Flex monocromatica 12Vdc

**IP20**

### LED Flex monocromatica 12V.



colour	W/m	L (mm)	IP	Led/mt	Beam angle	K	Lm/m	pcs	S+L	Q.tà	Euro	NET PRICE
T	4,8	5000	20	30	120°	3000	480	1	30919/S	145	95,00	<b>PROMO € 10,00</b>

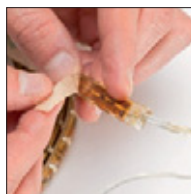

#### Per tutti i codici - For all codes

Strisce a LED applicabili su superfici lisce, pulite ed asciutte con adesivo 3M.

LED strips applicable to smooth, clean and dry surfaces with 3M adhesive.

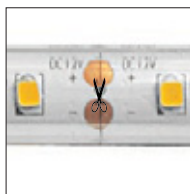

Effettuare il taglio in corrispondenza del simbolo della forbice e la linea tratteggiata.

Make the cut in correspondence of the scissor symbol and dotted line.

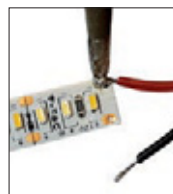

In caso sia necessario saldare dei nuovi cavi utilizzarli prestagnati e delle sezioni opportune; filo di stagno senza piombo con flussante no clean.

If it is necessary to weld eventual new cables, just use pre-solder and appropriate section cables, lead-free tin wire, with no-clean flushing.

# DOWNLIGHTS Professional

Downlights progettati per illuminare spazi commerciali (supermercati, grandi magazzini, retail, ecc.), uffici e qualsiasi ambiente dove è necessaria un'illuminazione generale e d'accento. La struttura del faretto è a base tonda o quadrata, con ottica orientabile ed estraibile.

**Installazione:** ad incasso in controsoffitti di cartongesso (completo di staffe di fissaggio).

**Corpo e telaio:** in lamiera di acciaio, verniciata con polvere termoindurente poliestere.

**Staffe di fissaggio:** in acciaio.

**Verniciatura:** di tipo poliestere eseguita a polvere. Colore nero, cromo o bianco RAL 9010.

**Ottica:** concentrante, semi concentrante e diffondente.

**Temperatura di colore:** 3000K - 4000K.

**Driver:** incluso  Fattore di potenza  $\geq 0,95$ .

**Conforme alla norma:** EN60598-1, RG0 nessun rischio fotobiologico ai fini della norma EN62471.

**Led:** **SAMSUNG - PHILIPS** mantenimento del flusso luminoso minimo al 80%: 50.000h (L80B10).

*Downlights designed to light up retail spaces (supermarkets, department stores, shops, etc.), offices and any other place that requires general and spot lighting. The luminaire structure is round or square, with extractable and adjustable optic.*

**Installation:** recessed use in plasterboard false ceilings (complete with fixing brackets).

**Body and frame:** made by steel sheet, coated with polyester thermoset powder

**Fixing brackets:** made by steel.

**Coating:** coated with powdered polyester. Black, chrome or RAL 9010 white color.

**Optic:** clumping, semi-clumping and diffused.

**Color temperature:** 3000K - 4000K.

**Driver:** included  Power factor  $\geq 0,95$ .

**According to standard:** EN60598-1, RG0 exempt from photo-biological risks in compliance with standard EN62471.

**Led:** **SAMSUNG - PHILIPS** maintenance of minimum luminous flux to 80%: 50.000h (L80B10).

## LED Moon



Fino ad esaurimento scorte - Until stock last

SPECIAL OFFER

**SPECIAL OFFER**

Quantitativo minimo **10** pezzi per cod. **Fino ad esaurimento scorte**  
 Minimum quantity **10** pieces per cod. **Untill stock last**

# LED Moon

A richiesta  
On demand**0-10V****WIRELESS**

Sorgente luminosa/ Light source - Vega o Meissa + Driver RN9163 (500mA)

220-240V 50/60Hz

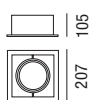
**IK07****IP20****LED Moon 1**

21W

**CRI >80**

colour	W max	K	Lm output	△	pcs	Kg	CELL	Q.tà	Euro	NET PRICE
B	21	3000	2170	40°	001	2.90	31750	300	60,00	<b>PROMO € 20,00</b>
B	21	4000	2170	40°	001	2.90	31750/4K	300	60,00	
N	21	3000	2170	40°	001	2.90	31350/M/NER	117	60,00	
G	24	3000	2170	40°	001	2.90	31050	70	60,00	

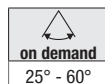
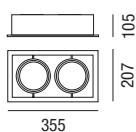
**LED Moon 2**

colour	W max	K	Lm output	△	pcs	Kg	CELL	Q.tà	Euro	NET PRICE
S	42	3000	4340	40°	001	4.00	32486	300	120,00	<b>PROMO € 25,00</b>
S	42	4000	4660	40°	001	4.00	32586	300	120,00	
B	42	3000	4660	40°	001	4.00	31059/WMEISSA	40	120,00	

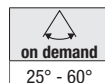
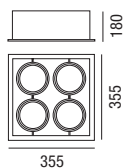
**LED Moon 4**

colour	W max	K	Lm output	△	pcs	Kg	CELL	Q.tà	Euro	NET PRICE
S	96	3000	8000	40°	001	6,00	31110	600	200,00	<b>PROMO € 50,00</b>
S	84	4000	8000	40°	001	6,00	31110/4000	600	200,00	



Quantitativo minimo **10** pezzi per cod. **Fino ad esaurimento scorte** - Minimum quantity **10** pieces per cod. **Untill stock last**

**SPECIAL OFFER**

Quantitativo minimo 10 pezzi per cod. Fino ad esaurimento scorte - Minimum quantity 10 pieces per cod. Until stock last

# DOWNLIGHTS Professional

## LED Occhio



### Orientabilità - Adjustability



Sorgente luminosa/ Light source - Vega o Meissa + Driver RN9163 (500mA)

220-240V 50/60Hz



IK07

IP20

### LED Occhio 1



on demand  
25° - 60°

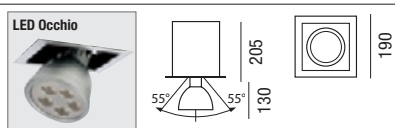

colour	W max	K	Lm output	△	pcs	Kg	CELL	Q.tà	Euro	NET PRICE
B	24	3000	2000	40°	001	2.10	31193	2000	40,00	<b>PROMO</b> <b>€ 15,00</b>
B	24	4000	1850	40°	001	2.10	31293	2000	40,00	
S	24	3000	2000	40°	001	2.10	31194	1000	40,00	
S	24	4000	1850	40°	001	2.10	31294	1000	40,00	

### LED Occhio black 1



on demand  
25° - 60°

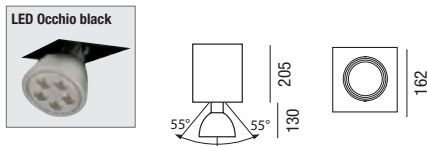

colour	W max	K	Lm output	△	on demand	pcs	Kg	CELL	Q.tà	Euro	NET PRICE
S	24	3000	2000	40°	25° - 60°	001	2,00	31196	2500	40,00	<b>€ 15,00</b>
S	24	4000	2000	40°	25° - 60°	001	2,00	31196/4K	2500	40,00	

SPECIAL OFFER



**SPECIAL OFFER**

Quantitativo minimo **10** pezzi per cod. **Fino ad esaurimento scorte**  
 Minimum quantity **10** pieces per cod. **Untill stock last**

# LED Occhio

## LED Occhio 2

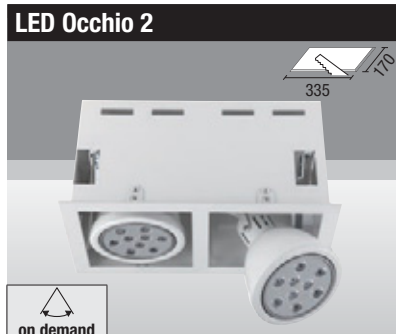

on demand  
25° - 60°

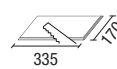
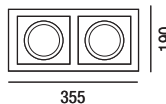
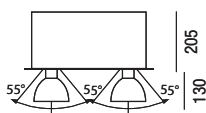

colour	W max	K	Lm output	Beam angle	on demand	pcs	Kg	CELL	Q.tà	Euro	NET PRICE
B	48	3000	4000	40°	25° - 60°	001	3.80	31184	2000	95,00	<b>PROMO € 25,00</b>
B	48	4000	3700	40°	25° - 60°	001	3.80	31384	2000	95,00	
S	48	3000	4000	40°	25° - 60°	001	3.80	31183	2000	95,00	
S	48	4000	3700	40°	25° - 60°	001	3.80	31383	2000	95,00	

## LED Occhio black 2



on demand  
25° - 60°

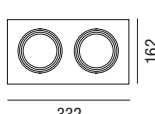
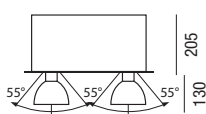

colour	W max	K	Lm output	Beam angle	on demand	pcs	Kg	CELL	Q.tà	Euro	NET PRICE
S	48	3000	4000	40°	25° - 60°	001	3,40	31185	1500	95,00	<b>€ 25,00</b>

## LED Occhio 3



on demand  
25° - 60°

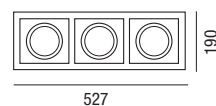
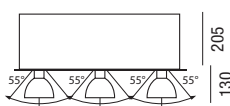

colour	W max	K	Lm output	Beam angle	on demand	pcs	Kg	CELL	Q.tà	Euro	NET PRICE
B	72	3000	6000	40°	25° - 60°	001	4.80	31148	2000	155,00	<b>PROMO € 50,00</b>
B	72	4000	6000	40°	25° - 60°	001	4.80	31348	2000	155,00	
S	72	3000	6000	40°	25° - 60°	001	4.80	31149	1400	155,00	
S	72	4000	6000	40°	25° - 60°	001	4.80	31349	1400	155,00	

## LED Occhio black 3



on demand  
25° - 60°

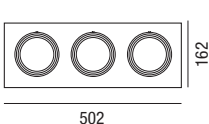
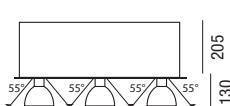

colour	W max	K	Lm output	Beam angle	on demand	pcs	Kg	CELL	Q.tà	Euro	NET PRICE
S	72	3000	6000	40°	25° - 60°	001	4,00	31206	2000	155,00	<b>PROMO € 50,00</b>
S	72	4000	6000	40°	25° - 60°	001	4,00	31306	2000	155,00	

Quantitativo minimo **10** pezzi per cod. **Fino ad esaurimento scorte** - Minimum quantity **10** pieces per cod. **Untill stock last**

**SPECIAL OFFER**

Quantitativo minimo 10 pezzi per cod. Fino ad esaurimento scorte - Minimum quantity 10 pieces per cod. Untill stock last

**SPECIAL OFFER** Quantitativo minimo **10** pezzi per cod. Fino ad esaurimento scorte  
 Minimum quantity **10** pieces per cod. Untill stock last

# LED Effect

A richiesta On demand **0-10V**   



Incassi a LED ideali per gli ambienti commerciali (supermercati, grandi magazzini, retail, ecc.) per uffici e in qualsiasi ambiente dove è necessario un'illuminazione diretta.

- Applicazione:** incasso.
- Corpo:** alluminio pressofuso UNI5076 sabbiato e viteria in acciaio.
- Orientabilità:** verticale 65°, orizzontale 350°.
- Riflettore:** alluminio anodizzato e brillantato + vetro di protezione.
- Verniciatura:** di tipo poliestere, eseguita a polvere.
- Driver:**  Incluso.
- UGR:** Secondo la Norma EN 12464-1.
- Conforme alla norma:** EN60598-1, RG0 nessun rischio fotobiologico ai fini della norma EN62471.
- Led:** mantenimento del flusso luminoso minimo al 80%: 50.000h (L80B10).

*LED Effect is the LED downlighter ideal for retail spaces (supermarkets, department stores, shops, etc.), offices and any other space that requires direct lighting.*



- Application:** recessed.
- Body:** sandblasted die cast aluminium UNI5076 and steel screws.
- Adjustable:** vertical 65°, horizontal 350°.
- Reflector:** polished and anodised aluminium + protective glass.
- Coating:** coated with powered polyester.
- Driver:**  Included.
- UGR:** According to Norm EN 12464-1.
- According to standard:** EN60598-1, RG0 exempt from photo-biological risks in compliance with standard EN62471.
- Led:** maintenance of minimum luminous flux to 80%: 50.000h (L80B10).

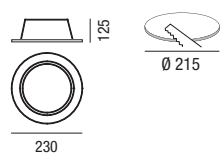

220-240V 50/60Hz     **IK07** **IP20**



**±155mm**  **±355°**

**A richiesta CRI >90 On request** **DRIVER INCLUDED MULTIPOWER**  **RG0** 

colour	W	mA		K	Lm	pcs	Kg	CELL	Q.tà	NET PRICE
<b>B</b>	19	500	40°	6000	2500	001	1.50	24106	1000	<b>PROMO € 20,00</b>
<b>B</b>	19	500	40°	3000	2500	001	1.50	24107	1000	
<b>B</b>	19	500	40°	4000	2500	001	1.50	24107/4k	1000	
<b>G</b>	19	500	40°	6000	2500	001	1.50	24106/G	600	<b>PROMO € 20,00</b>
<b>G</b>	19	500	40°	3000	2500	001	1.50	24107/G	600	
<b>G</b>	19	500	40°	4000	2500	001	1.50	24107/G/4k	600	

**SPECIAL OFFER**

**SPECIAL OFFER**

Quantitativo minimo **10** pezzi per cod. Fino ad esaurimento scorte  
 Minimum quantity **10** pieces per cod. Until stock last

A richiesta  
On demand

**0-10V**



**WIRELESS**



# LED Galileo

Sorgente luminosa/ Light source - Vega o Meissa + Driver RN9163 (500mA)

220-240V 50/60Hz



**IK07**

**IP20**

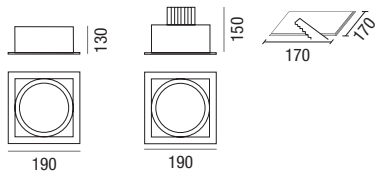

**DRIVER INCLUDED**  
**MULTIPOWER**



**CRI >80**

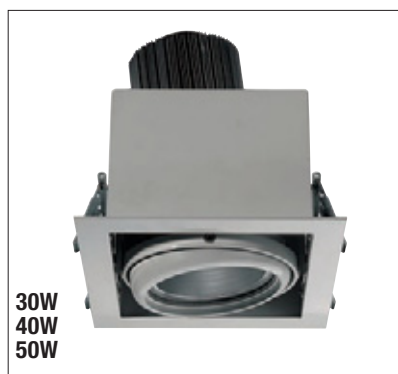

30W  
40W  
50W



colour	W	K	Lm output	Beam angle	on demand	pcs	Kg	CELL	Q.tà	Euro	NET PRICE
<b>N</b>	24	3000	2000	30°	15° - 40°	10	1.60	31062	700	60,00	<b>PROMO</b> <b>€ 20,00</b>
<b>C</b>	21	4000	2330	40°	25° - 60°	10	1.50	31301	1000	60,00	
<b>N</b>	24	4000	2000	30°	15° - 40°	10	1.60	31062/4K	700	60,00	
<b>C</b>	21	3000	2330	40°	25° - 60°	10	1.50	31301/3K	1000	60,00	
<b>N</b>	24	4000	2000	30°	15° - 40°	10	1.60	32240/4K	166	60,00	<b>PROMO</b> <b>€ 40,00</b>
<b>N</b>	30		3800								
<b>N</b>	40	3000	4800	40°	25° - 60°	10	1.60	31240	700	140,00	
<b>C</b>	30		3800								<b>PROMO</b> <b>€ 40,00</b>
<b>C</b>	40	3000	4800	40°	25° - 60°	10	1.60	31241	1000	140,00	
<b>C</b>	50		6000								
<b>N</b>	30		3800								<b>PROMO</b> <b>€ 40,00</b>
<b>N</b>	40	4000	4800	40°	25° - 60°	10	1.60	31240/4K	190	140,00	
<b>N</b>	50		6000								



24W

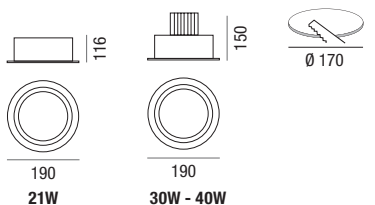

**DRIVER INCLUDED**  
**MULTIPOWER**



**CRI >80**



30W  
40W

colour	W	K	Lm output	Beam angle	on demand	pcs	Kg	CELL	Q.tà	Euro	NET PRICE
<b>B</b>	21	4000	2000	40°	25° - 60°	10	1.50	31230/R	800	95,00	<b>PROMO</b> <b>€ 20,00</b>
<b>B</b>	21	3000	2000	40°	25° - 60°	10	1.50	31094/R	800	95,00	
<b>B</b>	21	3000	2000	30°	25° - 60°	10	1.50	31074/R	800	95,00	
<b>B</b>	30		3800								<b>PROMO</b> <b>€ 40,00</b>
<b>B</b>	40	3000	4800	40°	25° - 60°	001	1.60	31239/R	800	160,00	
<b>B</b>	30	4000	4800	40°	25° - 60°	001	1.60	31239/R/4K	800	160,00	
<b>N</b>	30		3800								<b>PROMO</b> <b>€ 40,00</b>
<b>N</b>	40	4000	4800	40°	25° - 60°	001	1.60	31228/R	42	160,00	

Quantitativo minimo **10** pezzi per cod. Fino ad esaurimento scorte - Minimum quantity **10** pieces per cod. Until stock last

**SPECIAL OFFER**

Quantitativo minimo 10 pezzi per cod. Fino ad esaurimento scorte - Minimum quantity 10 pieces per cod. Untill stock last

**SPECIAL OFFER**

Quantitativo minimo **10** pezzi per cod. **Fino ad esaurimento scorte**  
 Minimum quantity **10** pieces per cod. **Untill stock last**

# LED Style

A richiesta **0-10V**   



Incassi a LED ideali per gli ambienti commerciali (supermercati, grandi magazzini, retail, ecc.) per uffici e in qualsiasi ambiente dove è necessario un'illuminazione diretta.

- Applicazione:** incasso.
- Corpo:** alluminio pressofuso UNI5076 sabbiato e viteria in acciaio.
- Orientabilità:** verticale 65°, orizzontale 350°.
- Riflettore:** alluminio anodizzato e brillantato + vetro di protezione.
- Verniciatura:** di tipo poliestere, eseguita a polvere.
- Driver:**  Incluso.
- UGR:** Secondo la Norma EN 12464-1.
- Conforme alla norma:** EN60598-1, RG0 nessun rischio fotobiologico ai fini della norma EN62471.
- Led:** mantenimento del flusso luminoso minimo al 80%: 50.000h (L80B10).

*LED Effect is the LED downlighter ideal for retail spaces (supermarkets, department stores, shops, etc.), offices and any other space that requires direct lighting.*

- Application:** recessed.
- Body:** sandblasted die cast aluminium UNI5076 and steel screws.
- Adjustable:** vertical 65°, horizontal 350°.
- Reflector:** polished and anodised aluminium + protective glass.
- Coating:** coated with powered polyester.
- Driver:**  Included.
- UGR:** According to Norm EN 12464-1.
- According to standard:** EN60598-1, RG0 exempt from photobiological risks in compliance with standard EN62471.
- Led:** maintenance of minimum luminous flux to 80%: 50.000h (L80B10).



**DIRECTABLE**  
  
 ±90°

220-240V 50/60Hz       **IK07** **IP20**

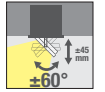
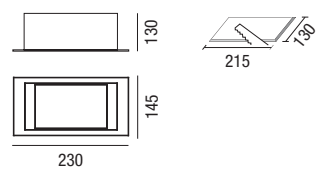

**A richiesta CRI >90** **DRIVER INCLUDED**  **MULTIPOWER**  **RG0** 

colour	W	mA		K	Lm	pcs	Kg	CELL	Q.tà	NET PRICE
B	18	500	60°	3000	2700	001	0,95	24250/LED	1300	<b>PROMO</b> <b>€ 30,00</b>
B	18	500	60°	4000	2700	001	0,95	24249/LED	1300	

**SPECIAL OFFER**

**SPECIAL OFFER****Quantitativo minimo 10 pezzi per cod. Fino ad esaurimento scorte**  
**Minimum quantity 10 pieces per cod. Untill stock last**

# LED Otto



Apparecchi da incasso progettati per illuminare aree comuni, corridoi, laboratori, sale riunioni, uffici e qualsiasi ambiente dove è necessaria un'illuminazione diffusa. La struttura del faretto è a base tonda o quadrata, ideale per sostituire apparecchi con sorgenti fluorescenti compatte.

**Installazione:** ad incasso in controsoffitti di cartongesso (completo di staffe di fissaggio).

**Corpo e telaio:** in alluminio pressofuso UNI 5076, verniciato con polvere termoidurente poliestere.

**Staffe di fissaggio:** in acciaio.

**Viteria:** in acciaio.

**Verniciatura:** di tipo poliestere eseguita a polvere. Colore bianco RAL 9010.

**Ottica:** diffondente.

**Schermo:** in lastra tecnopolimero opale

**Temperatura di colore:** 3000K.

**Driver:** incluso.

**Conforme alla norma:** EN60598-1, RG0 nessun rischio fotobiologico ai fini della norma EN62471.

*Recessed downlights designed to light up common areas, corridors, laboratories, meeting rooms, offices and any other place that requires diffused lighting. The luminaire structure is round or square, ideal to replace fixtures with compact fluorescent lamps.*

*Installation:* recessed use in plasterboard false ceilings (complete with fixing brackets)

*body and frame:* made by UNI 5076 die-cast aluminum, coated with polyester thermoset powder.

*Fixing brackets:* made by steel.

*Screws:* made by steel.

*Coating:* coated with powdered polyester. RAL 9010 white color.

*Optic:* diffused.

*Shield:* opal engineering polymer sheet.

*Color temperature:* 3000K.

*Driver:* included

*According to standard:* EN60598-1, RG0 exempt from photo-biological risks in compliance with standard EN62471.

220-240V 50/60Hz

**IK07****IP20**

## LED Otto Q3

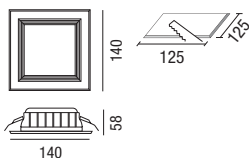
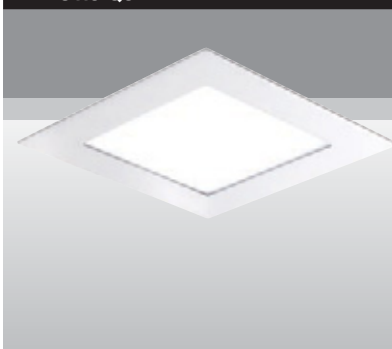
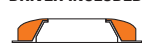
**DRIVER INCLUDED****CRI >80**

colour	Q..	W	lm output	K	pcs	Kg	CELL	Q.tà	Euro	NET PRICE
<b>B</b>	Q3	21	1.890	3000	001	0,50	25919/3000	1.478	45,00	<b>PROMO € 4,00</b>
<b>B</b>	Q3	18	1.400	4000	001	0,50	25900	70	45,00	

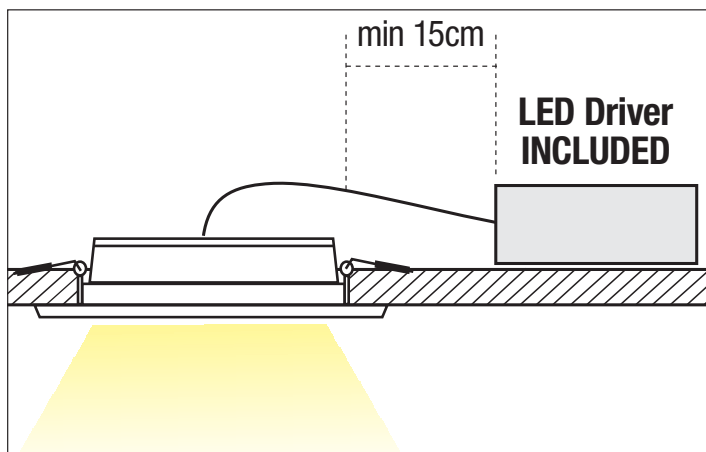

**SPECIAL OFFER**

Quantitativo minimo **10** pezzi per cod. **Fino ad esaurimento scorte**  
 Minimum quantity **10** pieces per cod. **Untill stock last**

# LED Star GU10

A richiesta  
On demand



Incassi con cornice rettangolare in acciaio verniciato di grigio per 2, 3 o 4 sorgenti orientabili, ideali per illuminare luoghi domestici e commerciali. La sua collocazione ideale è negli ambienti moderni con controsoffitti in cartongesso Star è un incasso versatile, semplice ed efficace.

**Corpo:** acciaio galvanizzato.

**Orientabilità:** verticale 60°, orizzontale 60°.

**Colori:** grigio (verniciatura di tipo poliestere eseguita a polvere).

**Sorgente LED:** GU10 inclusa.

**A richiesta:** 4000K.

*Rectangular steel downlight in grey. The round adjustable bulb sockets take up to 4 dichroic halogen or energy-saving LED lamps. Ideal for home or commercial lighting. Best suited to contemporary settings with false plasterboard ceilings. Galaxy is a versatile, simple and stylish downlight.*

**Body:** galvanised steel.

**Tilt adjustable:** 60° vertically, 60° horizontally.

**Colours:** grey (polyester powder coating).

**LED Source:** GU10 included.

**On demand:** 4000K.



220-240V 50/60Hz 850° **IK07** **IP20**

## LED Star 2

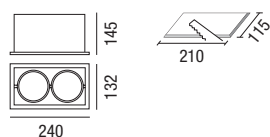

Sorgenti GU10 LED include.  
GU10 LED Source included.



colour	W	Lamps LED		Lm	K	pcs	Kg	S+L	Q.tà	Euro	NET PRICE
<b>G</b>	12	2X GU10	40°	900	3000	001	3.00	30763/NEW	800	25,00	<b>PROMO € 10,00</b>
<b>G</b>	12	2X GU10	40°	900	4000	001	3.00	30763/NEW4K	800	25,00	<b>PROMO € 10,00</b>

## LED Star 3

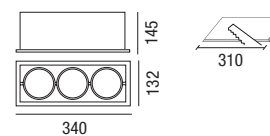

Sorgenti GU10 LED include.  
GU10 LED Source included.



colour	W	Lamps LED		Lm	K	pcs	Kg	S+L	Q.tà	Euro	NET PRICE
<b>G</b>	18	3X GU10	40°	1350	3000	001	3.00	30765/NEW	600	37,00	<b>PROMO € 10,00</b>
<b>G</b>	18	3X GU10	40°	1350	4000	001	3.00	30765/NEW4K	600	37,00	<b>PROMO € 10,00</b>

## LED Star 4

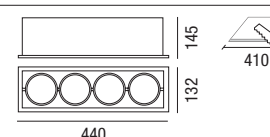

Sorgenti GU10 LED include.  
GU10 LED Source included.



colour	W	Lamps LED		Lm	K	pcs	Kg	S+L	Q.tà	Euro	NET PRICE
<b>G</b>	24	4X GU10	40°	1800	3000	001	3.00	30767/NEW	3000	45,00	<b>PROMO € 12,00</b>
<b>G</b>	24	4X GU10	40°	1800	4000	001	3.00	30767/NEW4K	3000	45,00	<b>PROMO € 12,00</b>

# LED Colonia

**SPECIAL OFFER**  
fino ad esaurimento scorte  
Until stock last



Serie di faretti orientabili da incasso per interni. Il bassissimo consumo energetico, la ridotta emissione di calore e la durata di oltre 50.000 ore sono le principali caratteristiche. LED di potenza adatta per musei, negozi, esposizioni. Nessuna emissione di raggi UV o infrarossi (non scoloriscono o scaldano gli oggetti).

**Installazione:** grazie allo spessore ridotto e alla presenza di molle di ancoraggio è applicabile con facilità a tutti i controsoffitti, sia domestici che commerciali. Adatta per illuminazione d'accento di superfici ed oggetti.

**Corpo:** alluminio spazzolato.

**Ghiera:** alluminio spazzolato.

**Diffusore:** lente acrilica trasparente.

**Sorgente:** LED di potenza bianco 3000K o 6000K.

**Alimentazione:** elettronica non inclusa vedere tabella a pag. 404. A richiesta alimentatore elettronico dimmerabile con comando a pulsante non fornito.

*Range of adjustable recess spot-lights for interiors. The salient features of this spot-light are its minimal energy consumption, low emission of heat and a lifespan of more than 50.000 hours. Power LED suited to museums, shops and exhibition spaces. It does not emit any UV or infra-red rays (it does not discolour or transmit heat to objects).*

**Installation:** thanks to its thinness and anchorage springs it can be easily applied on all false ceilings in both domestic and commercial settings. Ideal for the accentuated lighting of surfaces and objects.

**Body:** brushed aluminium.

**Ring nut:** brushed aluminium.

**Shade:** transparent acrylic lens.

**Source:** 3000K or 6000K white power LED.

**Power supply:** electronic, not provided. See table on page 404. Or request electronic dimmable driver with push button control (not included).



## LED Colonia 4 R move

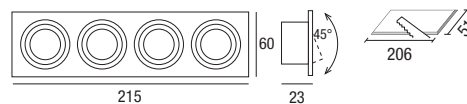

**CRI >80**

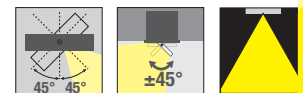

colour	W	mA	Beam	Chip	Lm	K	pcs	Kg	S+L	Q.tà	Euro	NET PRICE	
A	4	350	30°	B	1W x 4 Led	280	3000	001	0.27	90.019/012	185	40,00	<b>PROMO € 15,00</b>

## LED Colonia 5 R move

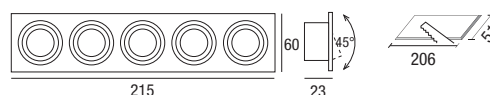

**CRI >80**

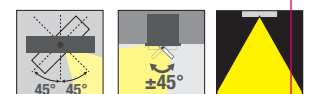

colour	W	mA	Beam	Chip	Lm	K	pcs	Kg	S+L	Q.tà	Euro	NET PRICE	
A	5	350	30°	B	1W x 5 Led	500	6000	001	0.27	90.020/01	150	49,00	<b>PROMO € 20,00</b>

# LED Direction

**SPECIAL OFFER**  
fino ad esaurimento scorte  
Until stock last

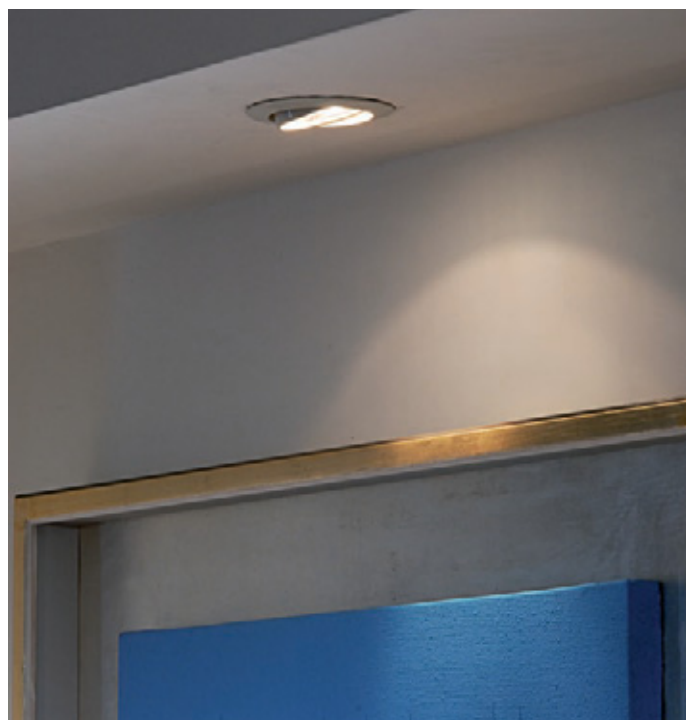

Faretto da incasso orientabile per interni.

**Installazione:** incasso a soffitto

**Corpo:** alluminio pressofuso

**Orientabilità:** verticale 45°

**Verniciatura:** di tipo poliesteri, eseguita a polvere Bianco RAL 9010, Nero RAL9005, Oro.

**Conforme alla norma:** EN60598-1, RG0 nessun rischio fotobiologico ai fini della norma EN62471.

**Sorgente Led:** non inclusa

*Adjustable flush mounting spotlight for interiors.*

**Installation:** ceiling flush mounting

**Body:** die-cast aluminium

**Adjustable:** vertical 45°

**Painting:** powder polyester coating White RAL 9010, Black RAL9004, Gold.

**Compliant with standard:** EN60598-1, RG0 no photobiological risk for the purposes mentioned in standard EN62471.

**LED Source:** not included.



## Direction 230V - Only body

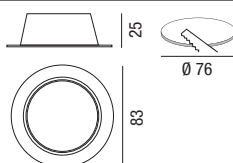

colour	pcs	ATTACCO	Kg	S	Q.tà	Euro	NET PRICE
B	050	GU10	0.10	54500	2.102	4,00	<b>PROMO € 0,50</b>
N	050	MR16	0.10	24490	1.906	4,00	
G	050	MR16	0.10	24525	3.520	4,00	

# LED Fermasy



## LED Fermasy

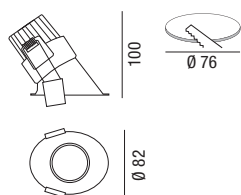

colour	pcs	Kg	S	Q.tà	Euro	PROMO
B	010	0.60	30777/A	200	10,00	<b>€ 2,00</b>
N	010	0.60	30778/A	200	10,00	





**SPECIAL OFFER**

Quantitativo minimo **5** pezzi per cod. Fino ad esaurimento scorte  
Minimum quantity **5** pieces per cod. *Untill stock last*

# LED Flash, technical metal



Apparecchi Corpi illuminanti multilampada in alluminio sabbiato con verniciatura di tipo poliesteri, eseguita a polvere per applicazione da soffitto e applique a combinazione mista, di design estremamente tecnico senza però precludere l'applicazione domestica, con possibilità di orientare ogni singola ottica tramite il sistema a snodo che ne agevola il puntamento sui tre assi. Ottimo per soddisfare una vasta gamma di esigenze illuminotecniche e per illuminazione di grandi spazi.

Driver LED e sorgenti luminose LED comprese.

*Multi-lamp light fixtures in sandblasted aluminium with polyester powder coating, for ceiling and wall applications in mixed combinations, with an extremely technical design however without impairing them from being used in homes, with the possibility of directing each individual optic by means of an articulation system which facilitates pointing on three axes. Ideal for meeting a wide range of lighting technical requirements and to illuminate large spaces.*

LED Driver and LED light source included.

220-240V 50/60Hz **IK07** **IP20**

## LED Flash 2

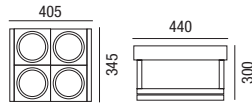

Sorgenti LED HL111 incluse.  
HL111 LED Source included.

DRIVER INCLUDED

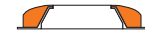

**CRI >80**



colour	W	lm output	K	pcs	Kg	CELL	Q.tà	Euro	NET PRICE
■	40	4.000	3000	001	2	25943	50	280,00	<b>PROMO € 75,00</b>
■	40	4.000	3000	001	2	25986	150	280,00	
[B]	40	4.000	4000	001	2	25976/4K	100	280,00	
■	40	4.000	4000	001	2	25992/4K	50	280,00	
■	40	4.000	4000	001	2	25985/4K	150	280,00	

## LED Flash 2S

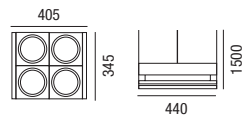

Sorgenti LED HL111 incluse.  
HL111 LED Source included.

DRIVER INCLUDED



**CRI >80**



colour	W	lm output	K	pcs	Kg	CELL	Q.tà	Euro	NET PRICE
[B]	40	4.000	3000	001	2	25946	130	280,00	<b>PROMO € 75,00</b>
■	40	4.000	3000	001	2	25947	260	280,00	
[B]	40	4.000	4000	001	2	26002/4K	130	280,00	
■	40	4.000	4000	001	2	26003/4K	50	280,00	

## LED Flash 1S

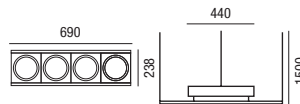

Sorgenti LED HL111 incluse.  
HL111 LED Source included.

DRIVER INCLUDED

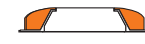

**CRI >80**



colour	W	lm output	K	pcs	Kg	CELL	Q.tà	Euro	NET PRICE
[B]	40	4.000	3000	001	2	25944	55	280,00	<b>PROMO € 75,00</b>
■	40	4.000	3000	001	2	25945	25	280,00	
[B]	40	4.000	4000	001	2	25974/4K	55	280,00	
■	40	4.000	4000	001	2	25975/4K	25	280,00	

Quantitativo minimo 5 pezzi per cod. Fino ad esaurimento scorte - Minimum quantity 5 pieces per cod. Untill stock last

**SPECIAL OFFER**

Quantitativo minimo **5** pezzi per cod. Fino ad esaurimento scorte  
Minimum quantity **5** pieces per cod. Untill stock last

# LED Flash, technical metal



220-240V 50/60Hz **IK07** **IP20**

## LED Flash 1

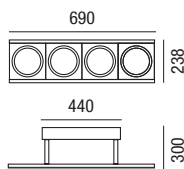

Sorgenti LED HL111 include.  
HL111 LED Source included.



**CRI >80**



colour	W	lm output	K	pcs	Kg	CELL	Q.tà	Euro	NET PRICE
	40	4.000	3000	001	2	25984/12V	338	280,00	<b>PROMO</b>
	40	4.000	4000	001	2	25983/4K	338	280,00	<b>€ 75,00</b>

## LED Flash 5

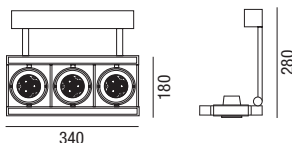

Sorgenti MR16 LED include.  
MR16 LED Source included.



**CRI >80**



colour	W	lm output	K	pcs	Kg	CELL	Q.tà	Euro	NET PRICE
	15	1.500	3000	001	1	25978/12V	275	180,00	<b>PROMO</b> <b>€ 35,00</b>
	15	1.500	3000	001	1	26024/12V	80	180,00	
	15	1.500	4000	001	1	25977/4K	275	180,00	
	15	1.500	4000	001	1	25979/4K	80	180,00	

## LED Flash 6

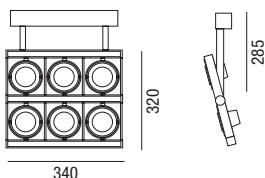

Sorgenti MR16 LED include.  
MR16 LED Source included.



**CRI >80**



colour	W	lm output	K	pcs	Kg	CELL	Q.tà	Euro	NET PRICE
	30	3.000	3000	001	2	25981/12V	250	300,00	<b>PROMO</b> <b>€ 55,00</b>
	30	3.000	3000	001	2	26025/12V	90	300,00	
	30	3.000	3000	001	2	26026/12V	60	300,00	
	30	3.000	4000	001	2	25980/4K	250	300,00	
	30	3.000	4000	001	2	25982/4K	90	300,00	
	30	3.000	4000	001	2	26029/4K	60	300,00	

**SPECIAL OFFER**

**SPECIAL OFFER**

Quantitativo minimo **10** pezzi per cod. **Fino ad esaurimento scorte**  
 Minimum quantity **10** pieces per cod. **Untill stock last**

# LED Moon C



LED Moon C è un apparecchio da plafone multilampada a LED ideale per gli ambienti commerciali (supermercati, grandi magazzini, retail, ecc.) per uffici e in qualsiasi ambiente dove è necessario un'illuminazione diretta.

**Può essere applicato a:** soffitto.

**Corpo:** alluminio galvanizzato con profilo e interno Bianco RAL 9010.

**Orientabilità:** dotato di snodo che consente l'orientamento della base e della singola sorgente luminosa  $\pm 60^\circ$  rispetto all'asse centrale e verticale.

**Cablaggio:** completo di alimentazione convenzionale, dotato di morsettiera a 3 poli sul primario e connessione rapida sul secondario.

**Conforme alla norma:** EN60598-1, RGO nessun rischio fotobiologico ai fini della norma EN62471.

**Led:** mantenimento del flusso luminoso minimo al 80%: 50.000h (L80B10).

*LED Moon C is an LED multi-lamp ceiling appliance ideal for commercial environments (shops, supermarkets, department stores, etc.) for offices and for anywhere that requires direct lighting.*

*It can be applied to: ceiling.*

*Body: in galvanised aluminium with RAL 9010 White.*

*Adjustability: fitted with a joint which allows the lamp head to be tilted  $\pm 60^\circ$  relative to the central and vertical planes.*

*Wiring: complete with electronic power supply, equipped with 2 pole terminal board on primary.*

*According to standard: EN60598-1, RGO exempt from photo-biological risks in compliance with standard EN62471.*

*Led: LUMILED maintenance of minimum luminous flux to 80%: 50.000h (L80B10).*

220-240V 50/60Hz



## LED Moon C1

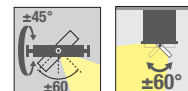
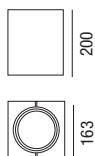

**CRI >80**



colour	W	mA	K	Lm		pcs	Kg	CELL	Q.tà	Euro	NET PRICE
[B]	27 (10-14)	700	6000	2600	30° (15°-45°)	001	2.90	30734	70	126,00	<b>PROMO</b>
[B]	27 (10-14)	700	3000	2450	30° (15°-45°)	001	2.90	30735	70	126,00	<b>€ 20,00</b>

Su richiesta sono disponibili nei colori Grigio e nero - Upon request available in Grey and Black colour

## LED Moon C2

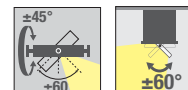
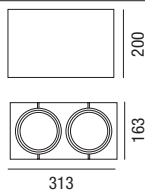

**CRI >80**



colour	W	mA	K	Lm		pcs	Kg	CELL	Q.tà	Euro	NET PRICE
[B]	54	700	6000	5200	30° (15°-45°)	001	3.90	30738	70	220,50	<b>PROMO</b>
[B]	54	700	3000	4900	30° (15°-45°)	001	3.90	30739	70	220,50	<b>€ 40,00</b>

Su richiesta sono disponibili nei colori Grigio e nero - Upon request available in Grey and Black colour

## LED Moon C3

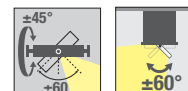
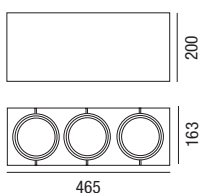

**CRI >80**



colour	W	mA	K	Lm		pcs	Kg	CELL	Q.tà	Euro	NET PRICE
[B]	81	700	6000	7800	30° (15°-45°)	001	4.90	30742	200	411,60	<b>PROMO</b>
[B]	81	700	3000	7350	30° (15°-45°)	001	4.90	30743	200	411,60	<b>€ 60,00</b>

Su richiesta sono disponibili nei colori Grigio e nero - Upon request available in Grey and Black colour

Quantitativo minimo 10 pezzi per cod. Fino ad esaurimento scorte - Minimum quantity 10 pieces per cod. Untill stock last

**SPECIAL OFFER** Quantitativo minimo **10** pezzi per cod. Fino ad esaurimento scorte  
 Minimum quantity **10** pieces per cod. *Untill stock last*

# LED Perth - LED Naska - 2700

## LED Perth

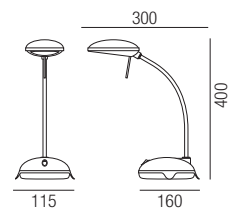

colour	W	K	Lm	pcs	Kg	CELL	Q.tà	NET PRICE
	3	4000	280	001	0.70	27204	285	<b>PROMO € 4,00</b>

## LED Naska - 2700

LED Naska

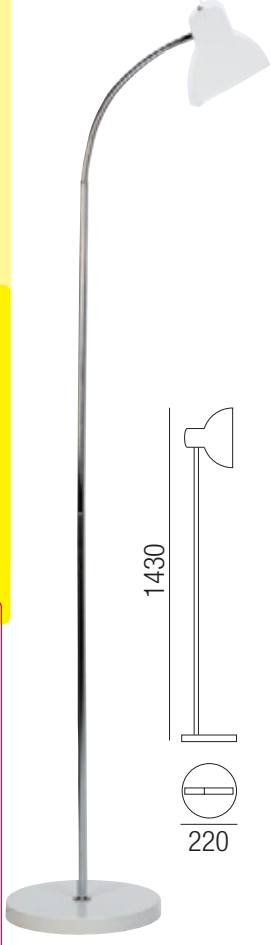

2007

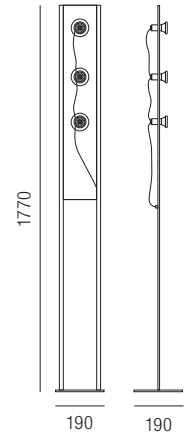
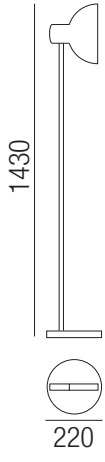

### LED Naska

colour	W	K	Lm	pcs	Kg	CELL	Q.tà	NET PRICE
<b>B</b> <b>C</b> Cromo Chrome	6	4000	300	001	0.70	27296	73	<b>PROMO € 15,00</b>

### 2007

colour	W	pcs	Kg	S	Q.tà	NET PRICE
<b>B</b> <b>N</b> Nikel satinato Satin Nikel	3XGU10*	001	2	2007/NKS	219	<b>PROMO € 15,00</b>

\*Sorgente luminosa NON COMPRESA  
 Light source NOT INCLUDED



**SPECIAL OFFER**

# LED GARDENA

100-240 Vac	50/60 Hz	IP66	IK09	CRI > 70	+40 C° -20		CE	850°			
Driver included 		RG0	LOW FLICKER								

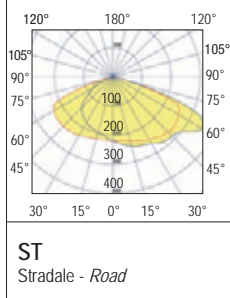

colour	W	LED	Optic	K	lm output	lm/W	pcs	Kg	CELL	QTY	Euro Netto
N	60	N° 24 Led 5050	ST	3000	7680	130	1	8,20	31561	97	80,00

# Plafoniere LED

Plafoniere a soffitto e/o parete con schermo antivandalo, resistente ai raggi UV e agli agenti atmosferici.

Per l'illuminazione di corridoi, terrazzi e porticati.

Corpo: base in alluminio

LED: Acrich

Schermo: vetro

Cablaggio: tramite morsetti interna

*Durable tamperproof and watherproof ceiling and wall lights.*

*Ideal for lighting corridors, terraces, porches, paths and damp environments in general.*

*Body: aluminium.*

*LED: Acrich*

*Shield: glass*

*Wiring: via internal terminal block*



220-240 Vac	50/60 Hz		CE			
----------------	-------------	--	----	--	--	--

Articolo - Article	Codice - Code CELL	Col.	(mm)	W	Sorgente Source	Lm	K	QTY	Euro Netto
	206S/BIALED3	CELL	White	210x145x100	Led Module Acrich 2 SEOUL	500	3000	700	5,00
	206S/NERLED3	CELL	Black			500	3000	700	5,00

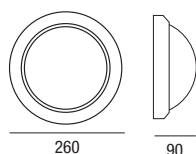

220÷240  
V

LED  
>50.000h

Sur demande  
Auf Anfrage  
CRI >80



colour	W		Lm	K	pcs	Kg	Codice - Code CELL	QTY	Euro Netto
S	17,5	B Acrich 2 module	1400	4000	010	1.25	205SA/SILLED3	300	10,00



Il LED Sports è un proiettore per l'illuminazione di stadi e strutture sportive, grandi infrastrutture (aeroporti, stazioni, ecc.), aree di parcheggio, zone di stoccaggio (industriali, portuali, ecc.).

La particolare forma permette di avere diverse potenze e fasci luminosi stretti e precisi, specifici per l'installazione a notevole altezza. La qualità delle parti elettroniche e del corpo lampada e dei materiali assicurano sicurezza in fase di esercizio nelle condizioni ambientali più critiche.

**Installazione:** su palo o a parete

**Corpo e telaio:** in lega di magnesio

**Staffa di fissaggio:** in acciaio zincato a caldo, con goniometro graduato per un corretto puntamento del fascio luminoso

**Verniciatura:** speciale eseguita a polvere, resistente agli agenti atmosferici e alla corrosione. Colore Grigio.

**Ottica:** concentrante e asimmetrica

**Schermo:** vetro temperato ultra-white resistente agli shock termici e agli urti

**Sorgente:** LED

Mantenimento del flusso luminoso minimo al 70%: 80.000h (L70B20) per l'80% dei LED.

**Temperatura di colore:** 5700K specifica per gli impianti con riprese televisive; altre temperature di colore a richiesta

**Driver LED:**

Meanwell certificato 

Fattore di potenza:  $\geq 0,9$

Protezione: 20kV

**Norme di riferimento**

EN60598-1; EN60598-2-1; EN62471; EN62031

EN60598-2-5; EN61547

*LED Sports is a projector for indoor and outdoor stadiums and sports grounds, large infrastructures (airports, stations, etc.), parking areas and storage areas (on industrial premises, at ports, etc.).*

*Different light intensities and narrow and precise light beams are possible due to the special design of the lamp body and light source, specifically for installation at a considerable height. The quality of the electronic parts, lamp body and materials ensure operating safety under even the most critical of environmental conditions.*

**Installation:** on pole or wall

**Housing and frame:** in magnesium alloy

**Fitting stirrup:** in hot galvanised steel with graduated goniometer for correct pointing of the light beam

**Coating:** special weather and corrosion resistant powder coating. Grey.

**Optics:** concentrator and asymmetric optics

**Screen:** ultra-white thermal shock and collision resistant tempered glass.

**Source:** LED

Maintenance of 70% minimum luminous flux: 80,000h (L70B20) for 80% of the LEDs.

**Colour temperature:** 5700K specifically for facilities with television filming; other colour temperatures on request

**Driver LED:**

Certified Meanwell 

Power factor:  $\geq 0.9$

Protection: 20kV

**Standard reference**

EN60598-1; EN60598-2-1; EN62471; EN62031

EN60598-2-5; EN61547



La certificazione fotometrica dei nostri apparecchi viene sempre effettuata da un istituto esterno. Efficienza luminosa e "lm Output" sono quindi il risultato di tale istituto.

*The photometric certification of our appliances is always carried out by an external institute. Luminous efficiency and "lm Output" are therefore the result of this institute.*

A richiesta - On demand

1-10Vdc



DYNA

Wireless

Vedi Pag. VI - See page VI

100-240 Vac	400 Vac On demand	50/60 Hz	IP66	IK09	CRI 90	+40 C° -20	+50 C° -20	On demand	850°		
				RG0	LOW FLICKER	Driver included  RIPPLE FREE					

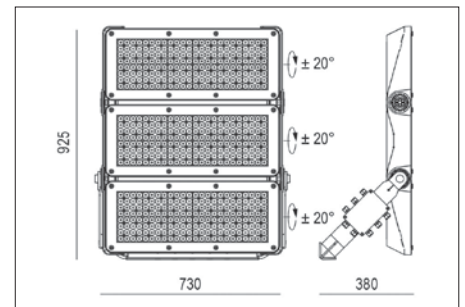
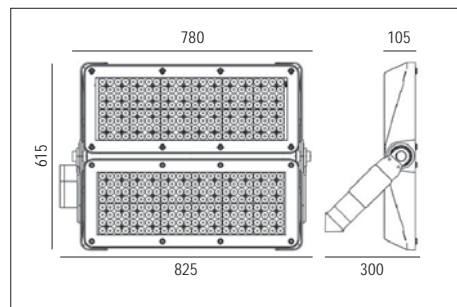
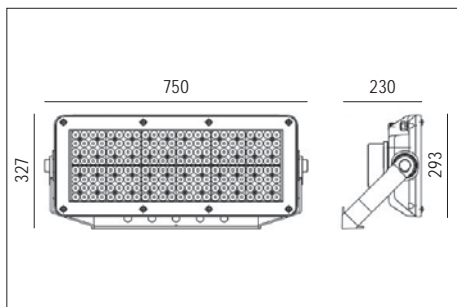

### LED Sports 1

colour	W	angle	K	lm output	lm/W	pcs	Kg	CELL	QTY	Euro Netto
	480	ASY	5700	51.500	107	1	21,00	35500-ASY	70	400,00
	600	15°	5700	66.000	111	1	21,00	35500	11	400,00

### LED Sports 2

colour	W	angle	K	lm output	lm/W	pcs	Kg	CELL	QTY	Euro Netto
	1000	ASY	5700	97.000	97	1	31,00	35501-ASY	4	800,00
	1200	15°	5700	132.000	111	1	31,00	35501	56	800,00

### LED Sports 3

colour	W	angle	K	lm output	lm/W	pcs	Kg	CELL	QTY	Euro Netto
	1500	ASY	5700	202.000	135	1	43,00	35502-ASY	2	1.200,00
	1800	15°	5700	243.000	135	1	43,00	35502	2	1.200,00

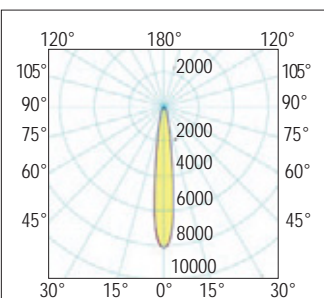

15°  
Concentrante - Narrow

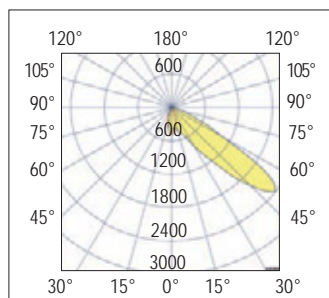

ASY  
Asimmetrico - Asymmetric

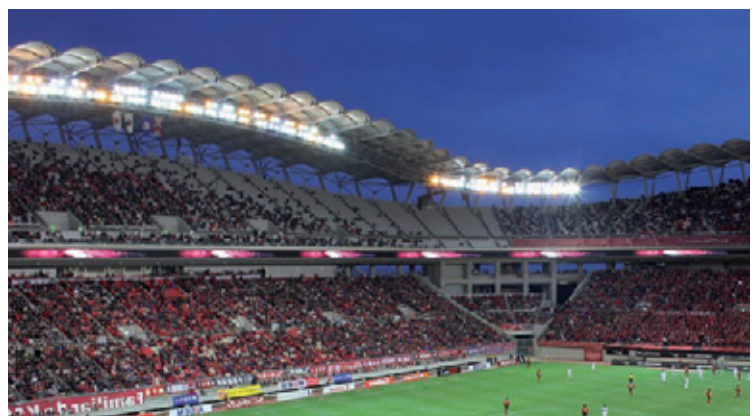

SPECIAL OFFER

# LED AGP ATEX 2-22

Promozione valida fino ad esaurimento scorte  
Promotion valid until stocks last



Riflettore da incasso particolarmente adatto per magazzini, garage, stazioni di servizio e luoghi con atmosfera potenzialmente esplosiva. Completo di alimentatore elettronico.

**Installazione:** ad incasso su superfici in cartongesso

**Corpo e telaio:** in alluminio pressofuso

**PG:** pressacavo in metallo M16 (cavo Ø 4÷8mm<sup>2</sup>)

**Ottica:** diffusore realizzata in PMMA resistente ai raggi UV

**Sorgente:** LED PHILIPS lumileds

Mantenimento del flusso luminoso minimo al 90% - 100.000h (L90B10) per il 90% dei LED

**Driver:** incorporato

Fattore di potenza ≥ 0,95.

*Recessed reflector particularly suitable for warehouses, garages, service stations and places in general with potentially explosive atmosphere. Complete with electronic ballast.*

*Installation: recessed on plasterboard surfaces*

*Body and frame: die cast aluminum*

*PG: M16 metal cable gland (cable 4÷8mm<sup>2</sup>)*

*Optic: wide made of UV-resistant PMMA*

*Light source: LED PHILIPS lumileds*

*Maintenance of minimum luminous flux to 90% - 100.000h (L90B10) for 90% of LED.*

*Driver: certified.*

*Power factor ≥ 0,95.*

Use: the light fitting is suitable for the environment with a danger of explosion of gas, dust and combustible fumes. The light fittings meet the requirements of Government Decree 116/2016 Coll. and European Community Directive N°. 2014/34/EU.

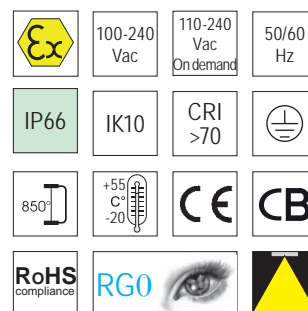
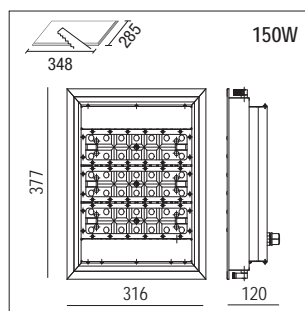
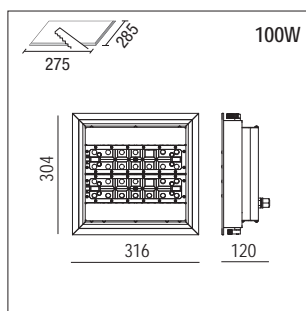

colour	W	angle	K	nominal lm tc = 25°C	lm output	lm/W	pcs	Kg	CELL	QTY	Euro Netto
S	100	110°	5000	18.000	15.000	150	1	9,70	334096.100ATX	144	100,00
S	150	110°	5000	27.000	25.000	150	1	9,70	334096.150ATX	38	

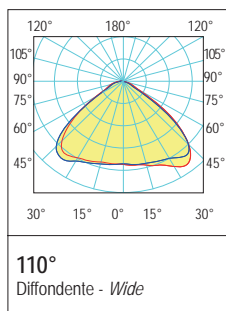

Protezione contro le atmosfere esplosive <i>Protection against explosive atmospheres</i>	CE Ex II M2 G Ex deia IIC T4
Zona pericolosa ammessa <i>Hazardous area allowed</i>	Zona 2 - Zone 2 Zona 22 - Zone 22
Normative di riferimento <i>Standard references</i>	EN 60079-0:2012/A11:2013 EN 60079-10-1:2015 EN 60079-10-2:2015, EN 60079-7:2015 EN 60079-11:2012, EN 60079-1:2014 EN60079-31:2014

## Dettagli - Details



Utilizzare il connettore impermeabile M16 per evitare danni all'alimentazione.

Use M16 waterproof connector, avoid hard power damage.



Il supporto per telaio innovativo non solo rende l'installazione più semplice, ma anche più solida.

The exquisite and innovated frame holder not only makes the installation more simple but also firmer.



Utilizzare un connettore impermeabile per il cablaggio interno, sicuro e veloce.

Use waterproof connector for internal wiring, safe, convenient & fast.



Connettore a innesto rapido innovativo, pulito ed efficiente.

Innovative pluggable connector, clean & efficient.



Di rapida installazione. Convenient & fast installation.



Materiale non soggetto a problemi di corrosione.

With a non-corrosive material, not only exquisite appearance, but also no corrosion concerns.





Nasce nel 1967 dalla passione e dall'ingegno di Giuseppe Pisati. Inizialmente l'azienda si occupa di elettronica applicata all'illuminazione.

Nel 1967 crea il primo variatore a Triac subito utilizzato dalle più importanti aziende di illuminazione di design come Flos, Artemide, Fontana Arte, Foscarini, Oluce e molti altri: è l'inizio di una lunga serie di successi.

**Relco** progetta e produce apparecchi elettronici; LED driver, trasformatori, dimmer, sistemi di emergenza, ottenendo le certificazioni di sicurezza e qualità richieste dal mercato, sempre nel rispetto delle norme internazionali.

La tecnologia LED è in continua evoluzione, per questo lo staff tecnico **Relco** è costantemente alla ricerca di soluzioni sempre all'avanguardia.

Il solido know-how nel campo della componentistica ha permesso a **Relco** di andare oltre, sviluppando una propria linea di apparecchi di illuminazione con più di 500 prodotti, da utilizzare sia in outdoor che indoor. Molti dei nostri progetti sono consultabili nel sito:

[www.relcogroup.com](http://www.relcogroup.com)

It was established in 1967 out of the passion and ingeniousness of Giuseppe Pisati.

Initially, the company dealt with electronics applied to lighting.

In 1967 it developed the first Triac dimmer, which was immediately adopted by the most important design lighting companies such as Flos, Artemide, Fontana Arte, Foscarini, Oluce and many more: it was the start of a long string of successes.

Relco designs and manufactures electronic equipment: LED drivers, transformers, dimmers, emergency systems, obtaining the safety and quality certificates required by the market, always in compliance with international standards.

LED technology is continuously evolving, that is why Relco's technical staff is constantly searching for cutting edge solutions.

The solid know-how in the components field has enabled Relco to go even further, developing its own range of lighting devices to be used both outdoors and indoors. Many of our projects can be viewed at:

[www.relcogroup.com](http://www.relcogroup.com)

## SERVIZIO AL CLIENTE - SERVICE FOR THE CUSTOMERS

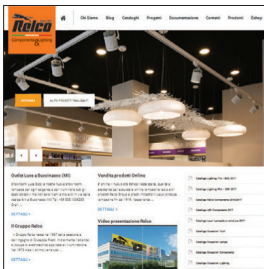

### Consulta il nostro sito ottimizzato per tablet e smartphone

Dovunque tu sia potrai avere informazioni dettagliate su: prodotti, punti vendita, informazioni tecniche e commerciali, e potrai effettuare il download di cataloghi, schede tecniche e listini aggiornati in tempo reale.

### Check out our website designed for tablets and smartphones

Wherever you are, you will be able to access detailed information on: products, outlets, technical and marketing information, and you will be able to download catalogues and price lists updated in real time.



### Assistenza tecnica

L'ampia gamma dei prodotti sviluppati da Relco, come lampadine LED, variatore, driver, lampade d'emergenza completano tutte le esigenze progettuali.

Per ulteriori chiarimenti contattare l'ufficio tecnico:

[tecnico@relcogroup.com](mailto:tecnico@relcogroup.com)

### Direct customer service

The wide range of products developed by RELCO, such as LED bulbs, dimmer, drivers, emergency lamps, complete all design requirements. For further information contact the Technical Department:

[tecnico@relcogroup.com](mailto:tecnico@relcogroup.com)

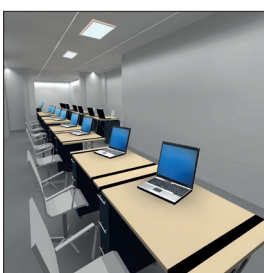

### Progettazione

La certificazione fotometrica dei nostri apparecchi viene sempre effettuata da un laboratorio fotometrico esterno. Efficienza luminosa e "lm Output" sono quindi il risultato di un ente terzo in alcun modo vincolato a Relco S.r.l. I progetti illuminotecnici sviluppati da Relco mettono a disposizione dei clienti le soluzioni più efficaci per esigenze spesso molto complesse. La definizione di ogni progetto determina un'autentica partnership tra le parti. La nostra realtà è a completa disposizione di progettisti che realizzano lavori con un alto profilo tecnologico: [projects@relcogroup.com](mailto:projects@relcogroup.com)

### Project

The lumen output performance of our lighting fixtures is always tested by third party accredited laboratories. The fixture efficiency and lm output are the results attested by a third party laboratory which is not bonded to Relco S.r.l. The lighting projects developed by Relco make the most efficient solutions to very complex issues available to customers. Defining each project results in an authentic partnership between the parties. Our company is at the full service of designers working on highly technological projects: [projects@relcogroup.com](mailto:projects@relcogroup.com)



## Controllo dell'abbagliamento

L'illuminazione degli spazi operativi in un'ottica smart, deve essere in grado di migliorare il senso di benessere di chi lavora seguendo le necessità degli utenti finali.

I sistemi di regolazione di **RELCO** consentono di trovare il giusto equilibrio tra luce artificiale e luce naturale proveniente dall'esterno.

Ciò consente di dare sostegno al bioritmo umano e creare le migliori condizioni visive per ogni attività.

Un ambiente confortevole sotto il profilo illuminotecnico incoraggia la creatività delle persone che lo abitano.

Relco offre soluzioni illuminotecniche globali, in grado di offrire valore aggiunto all'unione tra luce e architettura.

Ampia scelta di apparecchi LED e sistemi di comando per le applicazioni più svariate dell'illuminazione professionale di: uffici e istituti didattici, negozi, hotel e wellness, salute e cura, arte e cultura, industria e tecnica.

Relco sa trovare il giusto equilibrio fra qualità della luce ed efficienza energetica sviluppando soluzioni illuminotecniche su misura.

**Veniamo incontro alle vostre esigenze specifiche e alle necessità degli utenti, senza mai perdere di vista l'obiettivo di trovare la luce migliore per l'uomo e per l'ambiente.**

## Glare control

*The lighting of the work areas from a smart perspective must be able to improve the well-being of those who work according to the needs of end users.*

*The RELCO regulation systems allow the right balance to be found between artificial light and natural light coming from outside.*

*This allows us to support human biorhythm and create the best visual conditions for any activity.*

*A comfortable environment in terms of lighting encourages the creativity of the people who live in it.*

*Relco offers global lighting solutions, able to offer added value to the combination of light and architecture.*

*A wide selection of LED fixtures and control systems for various professional lighting applications: offices and educational institutions, shops, hotels and wellness, health and care, art and culture, industry and engineering.*

*Relco knows how to find the right balance between quality of light and energy efficiency by developing customised lighting solutions.*

***We meet your specific needs and users' needs, without ever taking our eyes off the goal of finding the best light for humans and the environment.***

## UGR<... Classificazione valori UGR in funzione delle applicazioni. UGR value classification based on application.

<b>UGR≤16</b>	<b>Applicazioni molto impegnative</b> (disegni tecnici, lavoro a videoterminale). <b>Highly demanding applications</b> (technical drawings, working with video display terminals).
<b>UGR≤19</b>	<b>Uffici e scuole</b> (lettura, scrittura, riunioni). <b>Offices and schools</b> (reading, writing, meetings).
<b>UGR≤22</b>	Applicazioni industriali, artigianato. <b>Industrial, artisanal applications.</b>
<b>UGR&gt;28</b>	Abbagliamento elevato. <b>High glare.</b>

### Fattore di abbagliamento UGR<19

Valore contemplato secondo la norma (coefficiente di riflessione: soffitto 0,7 - pareti 0,5).

### Factor glare UGR<19

Value calculated according to the standard (reflection coefficient: ceiling 0.7 - walls 0.5)

L'UGR è l'indicatore dell'abbagliamento diretto derivante dall'impianto di illuminazione.

La norma Europea per l'illuminazione dei posti di lavoro in interni **UNI-EN12464-1** richiede un valore UGR specifico per ogni applicazione, compreso tra 10 e 30. Più è basso il valore, minore è l'abbagliamento.

Il valore esatto di tale indice è da calcolare su progetto in quanto dipende dalla disposizione degli apparecchi illuminanti, dalle caratteristiche dell'ambiente (dimensioni, riflessioni) e dal punto di osservazione.

*UGR is the indicator to assess the direct glare coming from a lighting system. The UNI-EN12464-1 European standard for lighting indoor workplaces requires a specific UGR value for every application, ranging between 10 and 30. The lower the value, the lower the glare.*

*The exact value of this rating must be calculated in the design, as it depends on how the lighting fixtures are arranged, the features of the space (dimensions, reflections), and the viewpoint.*

# Prestazioni di alto livello - High level performances

## Aspettativa di vita del LED e suo decadimento LED service life expectancy and deterioration

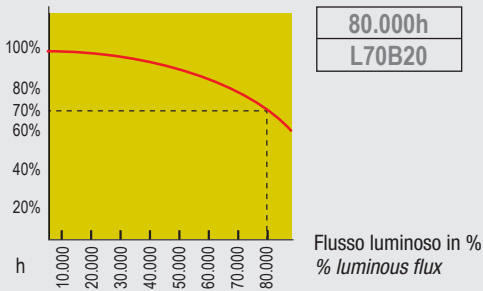

I LED diminuiscono gradualmente il loro flusso luminoso iniziale fino ad esaurirsi completamente in un periodo molto lungo. La durata di vita utile, indica la percentuale di decadimento del flusso luminoso (parametro "L") riferita ad un numero di ore utili di funzionamento. Il parametro "B" seguito da un valore normalmente compreso tra 10 e 50, indica la percentuale di componenti che, raggiunte le ore utili di funzionamento, non mantengono le caratteristiche di flusso luminoso dichiarate; ad esempio 80000h L70B20 vuol dire che l'80% dei moduli LED fornisce il 70% del flusso luminoso iniziale dopo 80000h di funzionamento.

The drop in LED flux is represented by acronym L70, which means flux at 70%. Value (B) followed by a value between 10 and 50 indicates the quality of the component being used, defining the percentage of LED that maintain the declared characteristics when the 80,000 hours have elapsed. Declared LED (L70B20) indicates that when 80,000 hours have elapsed, 80% (B20) of the LEDs have 70% of the flux they had at the beginning of their service life.

## Pittogramma Low Flicker Low Flicker pictogram



Apparecchio con flicker molto basso  
Product with a very low flicker

Flicker indica lo sfarfallio visibile a occhio nudo. Può verificarsi a frequenze inferiori a 60hz e dipende da diversi fattori tra cui il ripple di uscita degli alimentatori. E' importante definire "low" non vuol dire esente, ma ridotto.

Flicker is a common issue with LED lamps. It can occur at frequencies below 60 Hz and depends on several factors, such as the ripple emitted by drivers. Furthermore, "flicker-free" does not mean "without" but rather "very low".

## RIPPLE FREE

Il **RIPPLE FREE** è un esempio dello sviluppo e ricerca sui prodotti Relco Lighting & Components. I driver LED Relco Lighting & Components sono forniti di un circuito multistadio per alimentare i LED con una corrente perfetta. Con il termine RIPPLE si fa riferimento alla dimensione della forma d'onda della corrente d'uscita del driver LED. Dove il ripple è presente la forma d'onda si deforma con conseguente surriscaldamento del LED che ne riduce la vita media. Inoltre il ripple, causa oscillazioni della luce provocando disturbi durante le riprese video. Sullo schermo verranno visualizzate una serie di righe scure in movimento verso il basso che renderanno l'immagine illeggibile. Quando si alimentano i LED con LED Driver RIPPLE FREE è possibile raggiungere le massime prestazioni ed efficienza luminosa, con la minima dissipazione di calore.

The **RIPPLE FREE** is an example of R&D of the Relco Lighting & Components products. The Relco Lighting & Components LED drivers are provided with multistage circuit to feed the LEDs with a perfect current. The term RIPPLE refers to the dimension of the wave form of the LED driver output current, when present this deforms the same wave form with consequent overheating of the LED with reduced average life. Also this phenomenon, cause of light oscillations, results in effects while shooting videos, where the images appear to be cut with several black lines making shooting impossible. When you feed the LEDs with Led driver RIPPLE FREE you can achieve maximum performance and light efficiency, with minimal heat dissipation.

## Norme Europee di certificazione elettrica European norms electrical certification



Tutti i prodotti sono costruiti nel rispetto delle Normative Europee (2014/35/UE, 2006/95/CE, 2014/30/UE, 2004/108/CE, 2009/125/CE) come riportato nella dichiarazione di conformità UE.

All products are manufactured in compliance with European Directives (2014/35/UE, 2006/95/CE, 2014/30/UE, 2004/108/CE, 2009/125/CE) as reported in the UE conformity declaration.

## Sicurezza fotobiologica Photobiological safety



La sicurezza fotobiologica è determinata dalla quantità di radiazioni emesse dalle sorgenti luminose con lunghezza d'onda compresa tra 200nm e 3000nm.

Un'esposizione eccessiva alle radiazioni, può essere causa di danni per l'uomo. La norma EN62471 definisce una classificazione delle sorgenti in gruppi di rischio. RG0 Ethr: apparecchi che non presentano rischio fotobio-logico ai fini della Norma EN62471. Richiedere in sede la distanza dal punto di osservazione, se necessaria.

RG0: assenza di rischi fotobiologici ai fini della norma EN62471.

RG1 (gruppo di rischio basso): la sorgente non provoca rischi dovuti a normali limitazioni di funzionamento sull'esposizione.

RG2 (gruppo di rischio moderato): la sorgente non pro-voca un rischio in seguito ad una reazione istintiva guardando fonti molto luminose o in seguito ad una sensazione di disagio termico.

We often read about photo-biological safety in lighting design. This very important factor is determined by the amount of radiations emitted by all the sources with a wave length ranging between 200 nm and 3000 nm. Excessive radiation exposure can be harmful for human health. The EN62471 standard classifies light sources into risk groups. Risk Group 0 (RG0 Ethr): luminaires are exempt from photobiological risks in compliance with standard EN 62471. If necessary, contact our customer service for the observation distance.

RG0 (exempt risk group): the lighting source is exempt from risks in compliance with EN 62471 Standard.

RG1 (low risk group): no risk deriving from a limited emission of radiation.

RG2 (moderate risk): the lighting source does not pose hazards because of our aversion response to very bright light sources, or due to the fact that we would experience thermal discomfort.



ENEC è un Marchio Europeo di Certificazione di prestazione, è stato istituito in sede CENELEC (Comitato europeo di normazione elettrotecnica) dagli organismi di certificazione elettrica che hanno aderito ad un accordo denominato "LUM AGREEMENT" per il mutuo riconoscimento di un unico marchio "ENEC" equivalente ai singoli marchi degli organismi aderenti. ENEC è un marchio ad alto valore tecnico basato su severi criteri di certificazione che offre garanzie oltre che sulla sicurezza elettrica anche sulle prestazioni dell'apparecchio elettrico. A fianco del marchio ENEC viene posto un numero che identifica l'organismo che ha rilasciato la certificazione.

ENEC is a European Certification mark for performance established at CENELEC (European Committee for Electrotechnical Standardization) by electrical certification institutions. These bodies have entered an agreement called "LUM AGREEMENT" for the mutual recognition of a sole mark, "ENEC", equivalent to the single marks of the adhering institutions. ENEC is a high value technical mark based on strict certification criteria which offers a guarantee not only on electrical safety but also on the performance of the electrical apparatus.

## Certificazioni ISO 9001 ISO 9001 certification

## Cos'è la sovratensione? What is a surge?

È un rapido innalzamento del valore di tensione tra parti di diverse polarità e tra queste e la terra.

Alcune sovratensioni possono superare la soglia d'isolamento o di immunità dei componenti elettronici provocandone il disservizio.

*A surge is a rapid increase in voltage on a power line between parts of opposite polarities and/or the ground. Some power surges may exceed the isolation or immunity threshold of electronic components causing it to fail.*

## Dispositivi di protezione Surge protector

Per fare fronte ai danni causati da sovracorrenti o sovratensioni viene utilizzato un dispositivo di protezione conforme alla norma EN 61547 contro i fenomeni impulsivi atto a proteggere il modulo LED e il relativo alimentatore.

*To protect lighting installations from surge, i.e. the rapid increase in voltage between parts of opposite polarities and/or the ground, Relco Components & Lighting has equipped its luminaires with an EN 61547 compliant surge protector, capable of protecting the LED module and their related driver from voltage spikes, damages caused by lightning and overcurrents.*

## Modalità di protezione Protection modes

**Modo differenziale:** Surge tra i conduttori di alimentazione, tra il conduttore di sovratensione verso quello di neutro. Sostanzialmente, tra fase (L) e neutro (N) non si presentano sovratensioni molto elevate perché i picchi di tensione vengono soppressi da altre apparecchiature collegate alla rete elettrica; di conseguenza è sufficiente una protezione più bassa da sovratensione. A seconda della famiglia di prodotto, Relco Lighting & Components integra quindi una protezione fino a 6 kV.

**Modo comune:** Surge tra i conduttori di alimentazione, L/N, verso la terra o il corpo dell'apparecchio se quest'ultimo è in classe II (se questo è installato su palo metallico). Le sovratensioni di modo comune sono ad esempio generate dai fulmini, e possono raggiungere valori molto elevati. A seconda della famiglia di prodotto, Relco Components & Lighting integra una protezione fino a 8 kV (a richiesta 10kV).

**Differential mode:** Surge between power conductors, between the phase conductor to the neutral conductor. Substantially, between phase (L) and neutral (N) no substantial surges are present because voltage peaks are suppressed by other equipment connected to the power line; as a consequence a lower surge protector is sufficient. Depending on the type of product, Relco Lighting & Components provides a protection from surges of up to 6kV

**Common mode:** Surge between power conductors, L/N, to the ground or the body of the luminaire if it is classified in class II (i.e. it is installed on a metal pole). Overvoltage in the common mode are generated by lightning strikes and may reach very high levels. Depending on the type of product, Relco Lighting & Components provides a protection from surges of up to 8 kV (10kV upon request).

## Gli effetti delle sovratensioni The effects of surges

Sovratensioni di ridotta entità non comportano necessariamente l'immediato guasto di moduli LED o driver (se pur con protezione 4kV), se però si verificano ripetutamente possono provocare il deterioramento precoce dei LED e, di conseguenza, una durata ridotta. Sovratensioni elevate (caduta dei fulmini) si traducono invece nel guasto immediato dei moduli LED o dei driver. Nei moduli LED e nei driver le sovratensioni provocano correnti elevate (impulsi di energia). Questo fenomeno può provocare:

- guasto parziale o totale dei moduli LED o dei driver
- deterioramento accelerato dei moduli LED diminuendone la durata
- possibile guasto anche dell'interfaccia di comando

*Small overvoltages do not necessarily lead to the immediate failure of LED modules or drivers (albeit with 4kV protection), but if they occur repeatedly they can cause premature deterioration of the LEDs and, consequently, a shortened life span. High overvoltages (lightning strikes), on the other hand, result in immediate failure of the LED modules or drivers. In LED modules and drivers, overvoltages cause high currents (energy pulses). This phenomenon can cause:*

- partial or total failure of the LED modules or drivers
- accelerated deterioration of the LED modules reducing their duration
- possible failure of the command interface as well



## Riprese televisive con illuminazione a LED TV footage with LED lighting

Durante una trasmissione televisiva, si può notare un fastidioso sfarfallio delle immagini a rallentatore. Il fenomeno di "flicker", affatica la vista e distrae lo spettatore. Le cause dello sfarfallio possono essere: frequenza della modulazione, fluttuazione di tensione e numero di fotogrammi al secondo. Generalmente uno sfarfallio inferiore al 5% non da alcun fastidio durante le riprese fino a 150 fotogrammi al secondo. Un sistema di illuminazione con un fattore di sfarfallio (FF) inferiore a 5% è in grado di eliminare il disturbo percepito.

*During a broadcast it is not uncommon to perceive an annoying flicker especially during slow motion. This flicker is distracting and should be eliminated where possible. The circumstances that produce the flicker vary upon the frequency modulation, voltage and camera frame rate.*

*The table below provides a general rule of flicker factor values produced by various lighting systems. A flicker factor of less than 5% will generally not cause problems for slow motion replays at up to 150 frames per second. A lighting system with a flicker factor of less than 5% will eliminate the perceived flicker at most frame rates per second used within the sports television industry.*

*The acceptable level of flicker factor (FF) is indicated in the Illuminance Category Tables.*

Tabella dei valori Flicker Factor (FF)	
Tipo di illuminazione	Valore FF (indicativo)
Luce naturale	0%
Apparecchi LED. La % di sfarfallio dipende dal tipo di LED e alimentatore utilizzati	< 3%
Lampade a scarica con alimentatori ad alta intensità	< 4%
Lampade a scarica con alimentatori magnetici trifase in grado di emettere luce uniforme	8 - 20%
Lampade a scarica con alimentatori elettromagnetici monofase	30 - 50%

Flicker Factor reference table (FF)	
Lighting type	FF value (indicative)
Daylight	0%
LED Luminaires % of flicker depend upon the type of LED power supply	< 3%
Discharge lamps with high frequency ballasts	< 4%
Discharge lamps with 3-phase magnetic ballasts for uniform light	8 - 20%
Discharge lamps with single-phase magnetic ballasts	30 - 50%

# Protezione IP - IP Protection

Schema relativo alle cifre che compongono il grado IP	
<b>Significato relativo alla prima cifra del grado di protezione</b>	
1	Protezione da oggetti solidi maggiori di 50mm
2	Protezione da oggetti solidi maggiori di 12mm
3	Protezione da oggetti solidi maggiori di 2,5mm
4	Protezione da oggetti solidi maggiori di 1mm
5	Protezione da polveri
6	Protezione forte da polveri
<b>Significato relativo alla seconda cifra del grado di protezione</b>	
1	Protezione da gocce d'acqua
2	Protezione da gocce d'acqua deviate fino a 15°
3	Protezione da vapori d'acqua
4	Protezione da spruzzi d'acqua
5	Protezione da getti d'acqua
6	Protezione da getti d'acqua forti o mareggiate
7	Protezione contro l'immersione
8	Protezione contro l'immersione continua
Questo semplice schema ci suggerisce quindi che qualsiasi prodotto di illuminazione dovrà essere scelto in base al suo grado di protezione IP. Tale grado sarà il risultato della valutazione delle caratteristiche del luogo di installazione del medesimo prodotto e del suo impiego.	

Diagram of the numbers that make up the IP rating	
<b>Meaning of the first numbers of the protection rating</b>	
1	Protection from solid objects larger than 50 mm
2	Protection from solid objects larger than 12 mm
3	Protection from solid objects larger than 2.5 mm
4	Protection from solid objects larger than 1 mm
5	Protection from dust
6	Strong protection from dust
<b>Meaning of the second numbers of the protection rating</b>	
1	Protection from dripping water
2	Protection from dripping water when tilted up to 15°
3	Protection from spraying water
4	Protection from splashing water
5	Protection from water jets
6	Protection from powerful water jets or sea storms
7	Protection from immersion
8	Protection from continuous immersion
This simple diagram suggests that any lighting fixture must be chosen based on its IP rating. This rating will be the result of an assessment of the characteristics of the place of installation of the product itself and of its use.	

Esempi di IP presenti su alcuni apparecchi per interni ed esterni	
<b>IP44</b>	Il grado IP 44 garantisce la protezione contro la penetrazione di corpi solidi maggiori di 1 mm. Permette la protezione contro la penetrazione di liquidi da gocce, vapori o spruzzi in qualsiasi direzione
<b>IP54</b>	Il grado IP54 garantisce la protezione totale alla penetrazione di corpi solidi, di liquidi da gocce, vapori o spruzzi in qualsiasi direzione. Questo grado di isolamento non permette la penetrazione di polveri e liquidi non deve danneggiare l'apparecchiatura
<b>IP55</b>	Il grado IP55 garantisce la protezione totale alla penetrazione di corpi solidi, la penetrazione di liquidi da gocce, vapori, spruzzi e getti d'acqua in qualsiasi direzione. Inoltre non deve permettere la penetrazione di polveri e liquidi non deve danneggiare l'apparecchiatura.
<b>IP65</b>	Il grado IP65 garantisce la protezione totale alla penetrazione di corpi solidi, la penetrazione di liquidi da gocce, vapori, spruzzi e getti d'acqua in qualsiasi direzione. In questo grado di protezione, la penetrazione liquidi non deve danneggiare l'apparecchiatura
<b>IP66</b>	Il grado IP66 è garanzia di protezione totale alla penetrazione di corpi solidi e polveri, di penetrazione di liquidi da spruzzi, mareggiate e forti getti d'acqua in qualsiasi direzione. Anche in questo caso la penetrazione liquidi non deve danneggiare l'apparecchiatura
<b>IP67</b>	Il grado IP67 garantisce la protezione totale alla penetrazione di corpi solidi e polveri, la protezione contro l'immersione in acqua momentanea per 30 minuti a 1 metro di profondità.
<b>IP68</b>	Il grado IP68 permette una protezione totale alla penetrazione di corpi solidi e polveri, contro l'immersione in acqua permanente a 1 metro di profondità.
<b>IP68-xx</b>	Il grado IP68-XX permette una protezione totale alla penetrazione di corpi solidi e polveri, contro l'immersione in acqua permanente a xx metri di profondità

Examples of IPs present on some indoor or outdoor lamp	
<b>IP44</b>	The IP 44 rating ensures protection from penetrating solid bodies greater than 1 mm. It also ensures protection from dripping, spraying and splashing water in any direction
<b>IP54</b>	The IP 54 rating ensures complete protection from penetrating solid bodies as well as dripping, spraying and splashing water in any direction. This insulation rating ensures protection from dust ingress and penetrating liquids which must not damage the equipment.
<b>IP55</b>	The IP 55 rating ensures complete protection from penetrating solid bodies as well as from dripping, spraying, splashing water and water jets in any direction. Moreover, it must protect from dust ingress and penetrating liquids which must not damage the equipment
<b>IP65</b>	The IP 65 rating ensures complete protection from penetrating solid bodies as well as dripping, spraying, splashing water and water jets in any direction. With this insulation rating, penetrating liquids must not damage the equipment.
<b>IP66</b>	The IP 66 rating ensures complete protection from penetrating solid bodies and dust ingress, as well as from dripping, spraying, splashing water, sea storms and strong water jets in any direction. In this case as well, penetrating liquids must not damage the equipment
<b>IP67</b>	The IP67 rating ensures complete protection from penetrating solid bodies and dust ingress, and from temporary immersion in water for 30 minutes at a depth of 1 metre
<b>IP68</b>	The IP68 rating ensures complete protection from penetrating solid bodies and dust ingress, from permanent immersion in water at a depth of 1 metre
<b>IP68-xx</b>	The IP68-xx rating ensures complete protection from penetrating solid bodies and dust ingress, from permanent immersion in water at a depth of xx metres

## Sistemi di controllo Control systems

**0-10V**

Controllo dell'illuminazione in modo facile, elegante ed energeticamente efficiente con un dimming continuo. Permette una riduzione dei costi dell'illuminazione e del consumo di energia. Per tutti i componenti necessari vi consigliamo di fare riferimento al catalogo Relco Components scaricabile dal sito.

*Easy access mode for controlling the illumination, elegant and energy-efficient through a continuous dimming. It permits a sensible cost-reduction of the illumination energy-consume. For all required components, please refer to the Relco Components catalogue which can be downloaded from the website.*



### Digital Address Lighting Interface

La regolazione mediante l'interfaccia digitale DALI (Digital Addressable Lighting Interface) rappresenta l'evoluzione della regolazione analogica. Questa interfaccia è stata sviluppata comunemente dai più importanti produttori di alimentatori elettronici per realizzare uno standard di regolazione comune all'industria mondiale illuminotecnica.

#### Caratteristiche principali della REGOLAZIONE DALI

- Memorizzazione di scenari luminosi;
- Messaggi per lampada guasta o a fine vita;
- Nessun problema con le fasi della rete;
- Nessuna necessità di rispettare la polarità dei cavi di regolazione;
- Possibilità di assegnare un indirizzo univoco ad ogni dispositivo connesso.

*Regulation by means of DALI (Digital Addressable Lighting Interface) digital interface represents an evolution in analogical regulation. This interface has been jointly developed by the most important producers of electronic drivers to create a standard regulation for the lighting engineering industry all over the world.*

#### Main features of the DALI REGULATION

- Memory function of light scenes;
- Messages for breakdown or end of life of the lamp;
- No problem with the phases of the supply mains;
- No need to observe the polarity of the regulation cables;
- Possibility to assign a unique address to each connected device.



Sistema di controllo con l'utilizzo di pulsanti standard per la gestione della tensione di rete al fine di regolare il flusso luminoso. Con una breve pressione si potranno accendere, spegnere e regolare i driver collegati. Il funzionamento può essere effettuato da più punti. Soluzione integrabile con sensore di luce.

*Control system with the use of standard buttons for managing the mains voltage in order to adjust the luminous flux. With a short press the connected drivers can be switched on, off and adjusted. Operation can be carried out from several points. Solution that can be integrated with light sensor.*

**WIRELESS**



Sistema di controllo puntuale dell'impianto mediante tecnologia senza la necessità dell'installazione di cavi elettrici.

La gestione è possibile mediante telecomando e/o smartphone.

*Thorough installation control system via technology not requiring electrical cables to be laid.*

*Management is possible via remote control and/or smartphone.*



#### Sensori di luminosità/presenza

Consentono un utilizzo intelligente della luce di spazi altrimenti difficilmente gestibili, ottenendo così importanti risparmi di energia.











L'uso dei sensori è consigliato in ambienti in cui vi sia un'occupazione saltuaria o dove è necessario un livello di illuminamento costante.











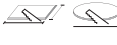

#### Brightness/presence sensor

*They do permit a very flexible utilization of the light in difficulties spaces, handled by a stable concept of illumination.*

*In addition, they do permit the easy handling and control of the in line with the different needs, obtaining important energy saving.*

# Legenda simboli - Symbols legend



















<b>colour</b>	Colore apparecchio - <i>Surface finish</i>
<b>W</b>	Watt
<b>pcs</b>	Quantità minima ordinabile - <i>Minimum quantity to be ordered</i>
<b>Kg</b>	Peso netto in Kg del prodotto - <i>Net product weight in Kg</i>
<b>time/flux</b>	Autonomia/flusso - <i>Duration/flux</i>
<b>A</b>	Ampere
<b>Hz</b>	Frequenza - <i>Frequency</i>
<b>V</b>	Volt
<b>colour</b>	Colore apparecchio - <i>Lamp colour</i>
<b>time/flux</b>	Autonomia/flusso - <i>Duration/flux</i>
<b>Hz</b>	Frequenza - <i>Frequency</i>
<b>LED</b>	Tipo di LED - <i>LED type</i>
<b>S</b>	Corpo apparecchio - <i>Body</i>
<b>S + L</b>	Corpo apparecchio + lampada - <i>Body + bulb</i>
<b>CELL</b>	Corpo apparecchio + alimentazione elettronica + scheda LED <i>Body + driver + circuit LED</i>
<b>CELL-E</b>	Corpo apparecchio + alimentazione elettronica + lampada + emergenza <i>Body + driver + Bulb + emergency kit</i>
	Rotazione dell'apparecchio sull'asse verticale e orizzontale <i>Rotation of the device on the vertical and horizontal axis</i>
	Dotato di vetro di protezione temperato <i>Equipped with tempered protection glass</i>
	Apparecchio costruito con materiali riciclabili <i>This device is made of recyclable materials</i>
	Apparecchio che resiste alla prova del filo incandescente <i>The device passes the glow wire test</i>
	Con isolamento funzionale in ogni parte e terminale o morsetto di terra se fisso <i>With functional isolation in each part and terminal or ground clamp if fixed</i>
	Con doppio isolamento, senza dispositivi per la messa a terra <i>With double insulation, without ground devices</i>
	Temperatura ambiente di funzionamento - <i>Operating ambient temperature</i>
<b>CRI</b>	Indice di Resa Cromatica <i>Color Rendering Index</i>
	Apparecchi calpestabili e/o carrabili con bassa emissione di calore sul diffusore. <i>Walkover or/and drive over fitting with low heat emission on the diffuser</i>
	HIGH EFFICIENCY
	Prodotto dotato di kit d'emergenza <i>Article with emergency kit</i>
<b>Lm/W</b>	Efficienza lm/W apparecchio - <i>Efficiency lm/W unit</i>
<b>nominal lm tc = 25°C</b>	Efficienza della sorgente luminosa - <i>Efficiency of the light source</i>
<b>lm output *</b>	Efficienza luminosa effettiva dell'apparecchio <i>Effective luminous efficiency of the fixture</i>

	Driver incluso nel prodotto <i>Driver included in the product</i>
	Driver non incluso, da ordinare a parte <i>Not included driver, to be ordered separately</i>
	Prodotto con certificazione CB <i>Product with CB certificate</i>
	Prodotto conforme alle direttive D.M. 11 Ottobre 2017 <i>In compliance with the directives D.M. 11 Ottobre 2017</i>
	Dimensioni foro incasso <i>Hole for fitting dimensions</i>
<b>IP</b>	Resistenza dell'apparecchio alla penetrazione di liquidi o solidi <i>Devices resistance to the penetration of liquids or solids</i>
<b>IK</b>	Grado di resistenza agli urti <i>Impact resistance degree</i>
	LED COB full color
	LED SMD singol color
	Resistenza dell'apparecchio alla penetrazione di liquidi o solidi <i>Devices resistance to the penetration of liquids or solids</i>
	LED COB FULL COLOR
<b>K</b>	Temperatura di colore in Kelvin <i>Kelvin colour temperature</i>
<b>3000K</b>	Temperatura di colore in Kelvin - luce calda <i>Kelvin color temperature - warm white</i>
<b>4000K</b>	Temperatura di colore in Kelvin - luce neutra <i>Kelvin color temperature - day lights</i>
<b>6000K</b>	Temperatura di colore in Kelvin - luce fredda <i>Kelvin color temperature - cool lights</i>
	A richiesta 4000K <i>On request 4000K</i>
	A richiesta 6000K <i>On request 6000K</i>
<b>0-10V</b>	Controllo dell'illuminazione in modo facile, con un dimming continuo. <i>Easy access mode for controlling the illumination, a continuous dimming.</i>
	Versatile e funzionale l'impianto DALI può essere integrato facilmente nei sistemi di automazione per edifici già esistenti <i>Versatile and functional, the DALI-mode function can be easily integrated in the automation-systems for already existing buildings</i>
	Sistema di controllo della luminosità attraverso pulsanti NA <i>Brightness control system through NO buttons</i>
Il flusso luminoso uscente dall'apparecchio viene indicato con una tolleranza di $\pm 10\%$ . <i>The luminous flux exiting the fixture is indicated with a tolerance of <math>\pm 10\%</math>.</i>	

\* Lm Output

La certificazione fotometrica dei nostri apparecchi viene sempre effettuata da un laboratorio fotometrico esterno. Efficienza luminosa e Lumen Output sono quindi il risultato di un ente terzo, in alcun modo vincolato a Relco S.r.l.  
*The photometric certification of our appliances is always carried out by an external photometric laboratory. Luminous efficiency and Lumen Output are therefore the result of a third party, in no way bound to Relco S.r.l.*

# Legenda simboli - Symbols legend

Applicazione apparecchi - <i>Appliance application</i>	
	Adatto per installazione in luoghi di culto. <i>Suitable for installation in places of worship.</i>
	Adatto per installazione in Hotel, Alberghi e luoghi di soggiorno. <i>Suitable for installation in hotels and places to stay.</i>
	Adatto per installazione in aule scolastiche. <i>Suitable for installation in classrooms.</i>
	Adatto per installazione in uffici con stazionamento di addetti a videoterminale. <i>Suitable for installation in offices with employees working at video terminals.</i>
	Adatto per installazione in uffici, corridoi, sale riunioni. <i>Suitable for installation in offices, corridors, meeting rooms.</i>
	Adatto per installazione in palestre, centri sportivi. <i>Suitable for installation in gyms, sports centres.</i>
	Adatto per illuminazione di opere d'arte, quadri. <i>Suitable for lighting works of art, paintings.</i>
	Adatto per installazione in Ospedale. <i>Suitable for installation in hospitals.</i>
	Adatto per installazione in Ipermercati, Supermercati. <i>Suitable for installation in hypermarkets, supermarkets.</i>
	Adatto per installazione in negozi in genere. <i>Suitable for installation in shops in general.</i>
	Adatto per installazione in parcheggi. <i>Suitable for installation in car parks.</i>
	Adatto per installazione all'aperto, terrazzi anche scoperti. <i>Suitable for installation outdoors, even open terraces.</i>
	Adatto per installazione in bagni. <i>Suitable for installation in bathrooms.</i>
	Adatto per installazione in zone umide. <i>Suitable for installation in wet areas.</i>
Colore corpo apparecchi - <i>Luminaire body color</i>	
	Bianco - <i>White</i>
	Nero - <i>Black</i>
	Grigio - <i>Grey</i>
	Argento sabbia - <i>Sanded silver</i>

	Argento - <i>Silver</i>
	Alluminio lucido - <i>Polished aluminum</i>
	Trasparente - <i>Transparent</i>
	Cromo - <i>Chrome</i>
	Oro - <i>Gold</i>
	Argento lucido - <i>Polished Silver</i>
	Trasparente - <i>Transparent</i>
	Specchio - <i>Mirror</i>
	Vetro satinato - <i>Frosted glass</i>
	Vetro fumè - <i>Fumè glass</i>
	Cromo - <i>Chrome</i>
	Rame - <i>Copper</i>
	Arancio - <i>Orange</i>
	Rosa - <i>Pink</i>
	Blu - <i>Blue</i>
	Vintage - <i>Vintage</i>
	Nikel - <i>Nikel</i>
	Wenghè - <i>Wenghè</i>
Colori paralumi - <i>Colour lampshade</i>	
	Bianco - <i>White</i>
	Écru - <i>Écru</i>
	Nero - <i>Black</i>
	Rosso - <i>Red</i>



## Light Emitting Diode

Il LED, Light Emitting Diode, diodo ad emissione di luce, è un dispositivo semiconduttore che genera luce al passaggio di cariche elettriche attraverso una giunzione in silicio opportunamente eccitato. Diversamente dalle sorgenti di luce tradizionali il LED non "brucia" ma nel tempo riduce l'intensità della luce emessa. La durata di vita dipende sia da una corretta progettazione della dissipazione termica dell'apparecchio illuminante, che dal driver che lo alimenta.

Negli anni il LED ha migliorato le prestazioni sia in termini di resa cromatica, fino ad arrivare ad un CRI>95, che di flessibilità nella temperatura di colore, che ha un range tra i 2700 K e i 6500 K. A tutte queste migliorie, proprie del LED, si aggiungono anche una serie di accessori abbinati allo stesso, che Relco può fornire, come driver dimmerabili, sensori di luminosità e di movimento, riducendo le emissioni di CO2.



### Vantaggi

- Durata di vita utile elevata (50.000h).
- Efficienza luminosa, fino ad 160lm/W.
- Regolazione del flusso luminoso (dimmerazione) a partire dall'1%.
- Flessibilità e compattezza dei moduli per un'ampia possibilità di utilizzo.
- Emissione di luce colorata senza utilizzo di filtri.
- Possibilità di controllo dinamico dei colori e bianco dinamico.
- Accensione immediata già a bassissime temperature (-35°).
- Assenza di componenti IR e UV nell'intero spettro elettromagnetico.
- Sicurezza fotobiologica.
- Riduzione dei costi di manutenzione.
- Dimezzamento dei consumi energetici.
- Rientro dell'investimento in breve tempo.

## Light Emitting Diode

*Light-emitting diode (LED) is a semiconductor light source that emits light when current flows through it.*

*Differently from the conventional types of light bulbs led doesn't "burn", but with time reduces the amount of light emitted. The life time depends firstly on a correct design of the heat dissipation of the lighting fixture and secondly by the driver which feeds it.*

*In the current years LED has improved its performance both in terms of color rendering where we can reach up to CRI>95 and also in the flexibility of the different color temperatures where it has a range from 2700K up to 6500K.*

*Other than all these improvements, there are also a series accessories to combine with LED that Relco can supply such as dimmable drivers, motion and light sensors which reduce the CO2 emissions.*

### Advantages

- Long life time (50.000 hrs).
- High light put efficiency, up to 160lm/W.
- Regulation of the light flux (dimming) starting from 1%.
- Flexibility and compactness of the modules for a wide range of utilization.
- Emission of colored light without filters.
- Possibility of dynamic control of colors and also dynamic white.
- Immediate power even at low temperatures (-35°).
- Exemption of IR and UV rays.
- Photobiologic safety.
- Reduction of maintenance costs.
- Reduction of energy consumption.
- Economic return in a short period.

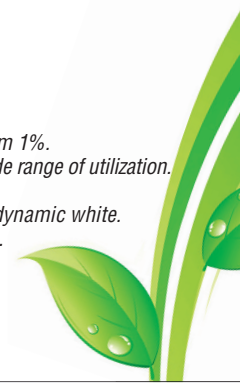



# Condizioni Generali di vendita - *General sales conditions*

Il presente listino sostituisce ed annulla tutte le precedenti edizioni. *This price list replaces and cancels all previous editions.*

## Condizioni generali

### **Spedizione Italia:**

Per poter ottenere il portofranco è necessario effettuare un ordine di almeno Euro 1.500 (unica consegna), diversamente il cliente avrà un addebito in fattura del 3%. Importo minimo fatturabile Euro 300.

La merce sarà evasa nel rispetto della quantità di cubetto o relativi multipli. Per eventuali richieste di disimballo sarà applicato un sovrapprezzo del 10%.

### **Imballo cartone**

Gratis. La merce viaggia a rischio e pericolo del committente. Trascorsi 8 giorni dal ricevimento merce non si accettano contestazioni.

### **Pagamento**

Per i nuovi clienti ad avviso di merce pronta; per i clienti abituali trascorsi termini di pagamento concordati verranno addebitati gli interessi di mora. Foro competente Milano.

### **Resi**

Prima di effettuare un reso è necessario richiedere e ottenere, a mezzo mail/fax, l'autorizzazione del nostro ufficio commerciale o del nostro agente di zona per concordarne le modalità. I resi inviati in porto assegnato e/o senza autorizzazione saranno respinti. Le riparazioni/sostituzioni vengono evase non prima di 30 giorni.

Quando il regolatore svolge funzioni vitali nell'impianto sarà necessario prevedere un'adeguata scorta o riserva fredda.

Non si effettuano sostituzioni anticipate.

Nel caso di errori di spedizione o di ordine, il prodotto deve essere reso imballato come all'origine.

### **Assicurazione RCP (responsabilità civile prodotti)**

I prodotti Relco S.r.l. sono marcati e in molti casi Omologati IMQ, VDE, ENEC ecc. per il dettaglio delle omologazioni vedi pagine interne. Tutti i prodotti Relco S.r.l. sono inoltre coperti da una speciale polizza RCP valida in tutto il mondo stipulata con una tra le più prestigiose compagnie di assicurazione.

**RELCO S.r.l.**, persegue una politica di continua ricerca e sviluppo, quindi si riserva di variare in qualsiasi momento e senza preavviso le caratteristiche dei prodotti illustrati. Le informazioni di questo catalogo svolgono un'azione esclusivamente informativa, ed essendo soggette a continue variazioni, non devono essere prese come un impegno da parte di Relco S.r.l.

Relco S.r.l. non si assume alcuna responsabilità per eventuali errori che si possono riscontrare nel presente catalogo. Nessuna parte di questo stampato può essere riprodotto, memorizzato, archiviato o trasmesso in qualsiasi forma o con qualsiasi mezzo elettronico, meccanico o altro, senza previa autorizzazione scritta di Relco S.r.l.

## General conditions

*Ex works minimum invoice charge € 2,500 (single delivery), otherwise the customer will be charged 3% on the invoice.*

*Minimum invoice charge 500 euros.*

*The goods will be processed according to cube-based amounts or relative multiples. A 10% charge will be applied on any unpacking requests.*

### **Cardboard packaging**

*Free. Goods travel at the risk and peril of the client. Complaints must be submitted no later than 8 days after receipt of the goods.*

### **Payment**

*On being informed that the goods are ready (for new clients); after the agreed deadline for the payment default, interest will be charged (for regular clients).*

*Any disputes shall be settled by the court of Milan.*

### **Returns**

*Before returning any goods, you need to request and obtain authorisation via email/fax from our sales office or our local representative to agree on how they will be returned. Goods sent on a carriage forward basis and/or without authorisation will be rejected. Repairs/replacements will not be processed for 30 days.*

*Provide for an adequate stock or cold reserve when the dimmer performs essential functions in the system.*

*We do not provide replacements in advance.*

*In case of shipping or order errors, the product must be returned in its original packaging.*

### **RCP insurance (civil liability on products)**

*Relco S.r.l. products are marked and in many cases type approved IMQ, VDE, ENEC, etc. Please see internal pages for details on type-approval. Moreover, all Relco S.r.l. products are covered by a special RCP insurance policy with one of the top insurance companies, which is valid in any country worldwide.*

*RELCO S.r.l. pursues a policy of continuous research and development and therefore reserves the right to change the characteristics of the products without prior warning. The information in this catalogue is only meant for informative purposes and is subject to constant changes, which means that it must not be considered as a commitment on behalf of Relco S.r.l.*

*Relco S.r.l. shall not be liable for any errors reported in this catalogue. No part of this publication can be reproduced, saved, filed or transmitted under any form and by any electronic, mechanical or any other kind of means without the prior permission in writing of Relco S.r.l.*

# Termini e condizioni di garanzia - *Warranty terms and conditions*

## La garanzia è applicabile solo quando:

1. I prodotti sono installati, utilizzati e mantenuti in conformità alle specifiche tecniche indicate nella marcatura del prodotto (con riferimento specifico al voltaggio e alla temperatura di funzionamento), alle istruzioni fornite insieme al prodotto e alle norme vigenti.
2. L'installazione e la manutenzione sono eseguite da personale tecnico qualificato.
3. Il difetto segnalato pregiudica il funzionamento del prodotto.
4. Il prodotto non è stato in alcun modo modificato, alterato o trattato con agenti chimici o in qualsiasi altra maniera, senza previa autorizzazione scritta di Relco S.r.l.
5. Il prodotto oggetto della garanzia è messo a disposizione di Relco S.r.l. per ulteriori analisi tecniche e per il tempo necessario al il suo svolgimento.
6. Il difetto deve essere denunciato per iscritto a Relco S.r.l. entro 30 (trenta) giorni dalla data del ricevimento dei prodotti (in caso di difetti apparenti) o dalla scoperta del difetto (in caso di difetti occulti).
7. La garanzia ha effetto immediato dalla data di acquisto e farà fede la data della fattura di vendita.
8. Periodi di garanzia superiori a 24 mesi potranno essere richiesti dall'acquirente e verranno accordati dopo aver valutato le condizioni di applicazione specifiche.

Nel caso in cui il difetto venga riconosciuto, Relco S.r.l. sceglierà, a sua discrezione, se riparare o sostituire il prodotto con lo stesso prodotto o con prodotti equivalenti, tenendo in considerazione l'evoluzione tecnica dei prodotti e dei loro componenti.

Qualsiasi intervento tecnico o sostituzione (parziale o completa) del prodotto effettuato in garanzia non darà comunque diritto a prolungamenti o rinnovi della stessa oltre i 24 mesi dalla data della fornitura, in quanto la relazione legale tra le parti non è rinnovata.

La riparazione o la sostituzione del Prodotto, non include costi o spese per la rimozione o reinstallazione. Relco S.r.l. non rimborserà alcuna perdita consequenziale subita a causa di un prodotto difettoso, come ad esempio costi di spedizione, costi di assemblaggio, costi di installazione in loco, perdita di profitto, costi complessivi degli acquirenti.

## Esclusioni e limitazioni

La presente garanzia non include:

- A. I costi e le spese della manodopera, costi e spese delle attrezzature magazzino e qualsiasi altro costo extra relativo e/o risultante da qualsiasi lavoro necessario per riparare il difetto (es. costi/spese del montaggio e smontaggio, trasporto degli apparecchi difettosi, da riparare e nuovi prodotti) saranno a carico del cliente.
- B. I componenti elettrici soggetti ad usura che sono assimilabili a materiale di consumo (ad esempio, batterie).
- C. I prodotti realizzati su specifica richiesta del cliente e da lui approvati.
- D. Danni al prodotto dovuti a negligenza, al trasporto o ad eventuali imprevisti e di prevedibili situazioni che non rientrino nelle normali condizioni di utilizzo di cui al punto 1 (ad esempio scariche elettriche e fulmini);

La presente garanzia speciale non si applica se l'apparecchio non è usato per lo scopo per cui è stato realizzato;

La presente garanzia non garantisce l'integrità della verniciatura quando il prodotto viene utilizzato in un ambiente salino o in presenza di agenti corrosivi. In nessun caso Relco S.r.l. sarà responsabile per danni accidentali, compensativi, consequenziali, indiretti, speciali o altri danni.

La responsabilità di Relco S.r.l. per un difetto del prodotto sarà in ogni caso limitata alla somma pagata per quel prodotto difettoso.

Il decadimento del flusso è un fenomeno previsto durante la vita del LED e è quindi non protetto da garanzia.

## Controversie Tecniche

In caso di controversia tecnica le parti sottoporranno il prodotto in contestazione a perizia di Esperto Terzo nominato di comune accordo o, in mancanza di accordo, dal Presidente del Tribunale di Milano.

La valutazione dell'esperto sarà vincolante per entrambe le Parti.

Le spese verranno sostenute dalle Parti in misura del 50% ciascuna.

## The conventional warranty applies only when:

1. The products are installed, used and maintained in accordance with the technical specifications reported on the product's marking (with specific reference to the operating voltage and temperature), with the instructions provided with the product and with current standards.
2. Installation and maintenance are carried out by qualified technical personnel.
3. The reported defect affects the operation of the products.
4. The product has not been in any way modified, altered or treated with chemicals or in any other way without the prior written consent of Relco S.r.l.
5. The product covered by the warranty is made available by Relco S.r.l. for further technical analyses and for the time required to conduct them.
6. The defect must be notified in writing to Relco S.r.l. within 30 (thirty) days from the date of receipt of the goods (in case of visible defects) or from the discovery of the defect (in case of hidden defects).
7. The warranty has immediate effect from the purchase date, the invoice date serving as proof;
8. Warranty periods exceeding 24 months may be requested by the Purchaser and will be agreed after assessing the specific application conditions.

*In case of the defect is acknowledged by Relco S.r.l., the latter will choose at its discretion whether to repair or replace the product with the same product or with equivalent products, by taking into account the technical evolution of the products and of their components.*

*Any technical intervention or replacement (partial or complete) of the product made during the period covered by the warranty will not provide entitlement to extensions or renewals thereof beyond 24 months from the date of supply, as the legal relationship between the parties has not been renewed.*

*The repair or replacement of the product does not include costs or expenses for removal or reinstallation. Relco S.r.l. shall not be held liable and therefore shall not refund any consequential loss suffered as a result of a defective product, such as costs and shipping, assembly costs, on-site installation costs, loss of profit, the total costs of the buyers.*

## Exclusions and limitations

*This commercial warranty does not include:*

- A. Costs and expenses for labour, equipment/warehouse costs and expenses and any other extra cost relating to and/or resulting from any work needed to repair the defect (e.g. costs and expenses for assembly disassembly, transportation of defective appliances to be repaired and new products will be held by the customer);
- B. Electrical components subject to wear that are considered wear material (e.g. batteries, etc.)
- C. Products manufactured based on specific customer request, and approved by him;
- D. Damage to the product due to negligence, transport, unforeseen and unforeseeable events that do not fall under the normal conditions of use of 1 (such as electric shocks and lightning).

*This special warranty does not apply if the appliance is not used for the purpose it was manufactured for;*

*This warranty does not guarantee the paintwork will remain intact when the product is used in a saline environment or in the presence of corrosive agents.*

*Relco S.r.l. will not, under any circumstances, be responsible for accidental, compensatory, consequential, indirect, special or other kind of damage. The responsibility for Relco S.r.l. for a product defect will be in any case limited to the amount paid for that defective product.*

*The depreciation of the flow is a phenomenon expected during the life of the LED and is therefore not protected by warranty.*

## Technical disputes

*In the event of a technical dispute, the parties will have the product examined by a third-expert appointed by mutual agreement or, if no agreement is reached, by the president of the Court of Milan.*

*The evaluation of the expert will be binding for both parties.*

*Each party will cover 50% of the expenses.*

## RELCO Group Italia



RELCO S.r.l.  
Via delle Azalee, 6/A  
20090 Buccinasco - Milano  
Italy  
Tel. +39 02 488616.1 r.a.  
relcogroup.com

• RELCO Group Germany GmbH  
Hilden/Düsseldorf, Deutschland

• RELCO Group Italia  
Buccinasco - Milano

• RELCO SUD  
Santa Ninfa, Trapani

RELCO Lighting Middle East  
Dubai (UAE)

## RELCO Sud sito produttivo



RELCO SUD S.r.l.  
Zona industriale lotti 19/20  
91020 Santa Ninfa, Trapani  
Italy  
Tel. +39 0924 60330  
Fax +39 0924 62388  
e-mail: relcosud@gmail.com

## RELCO Group Germany GmbH



Agnes - Pockels - Str. 9  
40721 - Hilden/Düsseldorf  
Deutschland  
Tel. +49 (0) 2103 9119 5  
Fax +49 (0) 2103 9119 69  
e-mail: info@relcogroup.de

## RELCO Lighting Middle East



Tel. +971 (0) 4 568 19 31  
e-mail: ahmed.az@relcogroup.com  
e-mail: joseph.pisati@relcogroup.com



Salone  
del Mobile.  
Milano

Saremo presenti a/we will be present  
Padiglione 11 - Stand 142

**EuroLuce.**

18 - 23. 04. 2023