



PRODOTTI & SERVIZI PER IL MONDO ELETTRICO

PRODUCTS & SERVICES FOR THE ELECTRIC WORLD

**CONSULTAZIONE RAPIDA
RAPID CONSULTATION**

www.sati.it

GUIDA ALLA SCELTA LINEA S5 / GUIDE FOR CHOOSING THE S5 LINE

Elemento rettilineo / Straight element	Forato Perforated	Non forato Solid bottom		Forato Perforated	Non forato Solid bottom	Forato con coperchio incernierato Perforated with hinged cover	Non forato con coperchio incernierato Solid bottom with hinged cover	
Lunghezza / Length	3000	3000	2000	3000	3000	3000	3000	
				Sp./Th. 1,5 mm	Sp./Th. 1,5 mm			
Dimensioni B x H / Dimensions B x H	Codice / Code	Codice / Code	ZS	Codice / Code	Codice / Code	ZS	ZS	
50 x 50	Corpo / Body	1X10001	1X20001	1020051	—	—	1060001	1061001
	Coperchio / Cover	1X30001	1X30001	1030051	—	—		
100 x 50	Corpo / Body	1X10003	1X20003	—	—	—	1060003	1061003
	Coperchio / Cover	1X30003	1X30003	—	—	—		
150 x 50	Corpo / Body	1X10004	1X20004	—	—	—	1060004	1061004
	Coperchio / Cover	1X30004	1X30004	—	—	—		
200 x 50	Corpo / Body	1X10005	1X20005	—	—	—	1060005	1061005
	Coperchio / Cover	1X30005	1X30005	—	—	—		
300 x 50	Corpo / Body	1X10006	1X20006	—	—	—	1060006	1061006
	Coperchio / Cover	1X30006	1X30006	—	—	—		
400 x 50	Corpo / Body	1X10007	1X20007	—	—	—	1060007	1061007
	Coperchio / Cover	1X30007	1X30007	—	—	—		
500 x 50	Corpo / Body	1X10008	1X20008	—	—	—	1060008	1061008
	Coperchio / Cover	1X30008	1X30008	—	—	—		
600 x 50	Corpo / Body	1X10009	1X20009	—	—	—	1060009	1061009
	Coperchio / Cover	1X30009	1X30009	—	—	—		
80 x 80	Corpo / Body	1X10201	1X20201	1020251	—	—	1060201	1061201
	Coperchio / Cover	1X30002	1X30002	1030052	—	—		
100 x 80	Corpo / Body	1X10202	1X20202	1020252	1X11100	1X21100	1060202	1061202
	Coperchio / Cover	1X30003	1X30003	1030053	1X30003	1X30003		
150 x 80	Corpo / Body	1X10203	1X20203	1020253	1X11150	1X21150	1060203	1061203
	Coperchio / Cover	1X30004	1X30004	1030054	1X30004	1X30004		
200 x 80	Corpo / Body	1X10204	1X20204	1020254	1X11200	1X21200	1060204	1061204
	Coperchio / Cover	1X30005	1X30005	1030055	1X30005	1X30005		
300 x 80	Corpo / Body	1X10205	1X20205	1020255	1X11300	1X21300	1060205	1061205
	Coperchio / Cover	1X30006	1X30006	1030056	1X30006	1X30006		
400 x 80	Corpo / Body	1X10206	1X20206	1020256	1X11400	1X21400	1060206	1061206
	Coperchio / Cover	1X30007	1X30007	1030057	1X30007	1X30007		
500 x 80	Corpo / Body	1X10207	1X20207	1020257	1X11500	1X21500	1060207	1061207
	Coperchio / Cover	1X30008	1X30008	1030058	1X30008	1X30008		
600 x 80	Corpo / Body	1X10208	1X20208	1020258	1X11600	1X21600	1060208	1061208
	Coperchio / Cover	1X30009	1X30009	1030059	1X30009	1X30009		
100 x 100	Corpo / Body	1X10401	1X20401	—	1X12100	1X22100	1060401	1061401
	Coperchio / Cover	1X30003	1X30003	—	1X30003	1X30003		
150 x 100	Corpo / Body	1X10402	1X20402	—	1X12150	1X22150	1060402	1061402
	Coperchio / Cover	1X30004	1X30004	—	1X30004	1X30004		
200 x 100	Corpo / Body	1X10403	1X20403	—	1X12200	1X22200	1060403	1061403
	Coperchio / Cover	1X30005	1X30005	—	1X30005	1X30005		
300 x 100	Corpo / Body	1X10404	1X20404	—	1X12300	1X22300	1060404	1061404
	Coperchio / Cover	1X30006	1X30006	—	1X30006	1X30006		
400 x 100	Corpo / Body	1X10405	1X20405	—	1X12400	1X22400	1060405	1061405
	Coperchio / Cover	1X30007	1X30007	—	1X30007	1X30007		
500 x 100	Corpo / Body	1X10406	1X20406	—	1X12500	1X22500	1060406	1061406
	Coperchio / Cover	1X30008	1X30008	—	1X30008	1X30008		
600 x 100	Corpo / Body	1X10407	1X20407	—	1X12600	1X22600	1060407	1061407
	Coperchio / Cover	1X30009	1X30009	—	1X30009	1X30009		

Per avere il codice completo inserire al posto della "X" i seguenti numeri:

0: Zincato Sendzimir - 1: Verniciato blu - 2: Verniciato grigio RAL 7035 - 4: Acciaio Inox AISI 304 - 7: Zincato a caldo.

To get the complete code to insert in place of "X" the following numbers:

0: Sendzimir galvanized steel - 1: Painted blue colour - 2: Painted gray RAL 7035 colour - 4: Stainless steel AISI 304 - 7: Hot-dip galvanized steel.

S5 SISTEMA DI PASSERELLE E CANALI AD INCASTRO

CABLE TRAYS AND CABLE TRUNKINGS SYSTEM WITH SLIDE IN

GUIDA ALLA SCELTA LINEA S5 / GUIDE FOR CHOOSING THE S5 LINE

Curva piana 45° 45° horizontal elbow	Curva piana 90° 90° horizontal elbow	Derivazione a "T" Horizontal tee	Derivazione laterale Tee branch	Derivazione piana a incrocio Horizontal cross	Raccordo di riduzione centrale Straight reducer	Raccordo di riduzione destra Right-hand reducer
						
Codice / Code	Codice / Code	Codice / Code	Codice / Code	Codice / Code	Codice / Code	Codice / Code
1X40001	1X40151	1X40301	1X40451	1X40601	—	—
1X50001	1X50051	1X50101	1X50151	1X50201	—	—
1X40003	1X40153	1X40303	1X40453	1X40602	—	—
1X50003	1X50053	1X50103	1X50153	1X50203	—	—
1X40004	1X40154	1X40304	1X40454	1X40603	1X40982	1X41073
1X50004	1X50054	1X50104	1X50154	1X50204	1X50252	1X50303
1X40005	1X40155	1X40305	1X40455	1X40604	1X40984	1X41075
1X50005	1X50055	1X50105	1X50155	1X50205	1X50255	1X50306
1X40006	1X40156	1X40306	1X40456	1X40605	1X40987	1X41078
1X50006	1X50056	1X50106	1X50156	1X50206	1X50259	1X50310
1X40007	1X40157	1X40307	1X40457	1X40606	1X40988	1X41079
1X50007	1X50057	1X50107	1X50157	1X50207	1X50260	1X50311
1X40008	1X40158	1X40308	1X40458	1X40607	1X40990	1X41081
1X50008	1X50058	1X50108	1X50158	1X50208	1X50260	1X50313
1X40009	1X40159	1X40309	1X40459	1X40608	1X40991	1X41082
1X50009	1X50059	1X50109	1X50159	1X50209	1X50263	1X50314
1X40051	1X40201	1X40351	1X40501	1X40651	—	—
1X50002	1X50052	1X50102	1X50152	1X50202	—	—
1X40052	1X40202	1X40352	1X40502	1X40652	—	—
1X50003	1X50053	1X50103	1X50153	1X50203	—	—
1X40053	1X40203	1X40353	1X40503	1X40653	1X41001 - 1X41002	1X41052 - 1X41053
1X50004	1X50054	1X50104	1X50154	1X50204	1X50251 - 1X50252	1X50302 - 1X50303
1X40054	1X40204	1X40354	1X40504	1X40654	1X41004 - 1X41005	1X41056
1X50005	1X50055	1X50105	1X50155	1X50205	1X50254 - 1X50255	1X50306
1X40055	1X40205	1X40355	1X40505	1X40655	1X41009	1X41060
1X50006	1X50056	1X50106	1X50156	1X50206	1X50259	1X50310
1X40056	1X40206	1X40356	1X40506	1X40656	1X41010	1X41061
1X50007	1X50057	1X50107	1X50157	1X50207	1X50260	1X50311
1X40057	1X40207	1X40357	1X40507	1X40657	1X41012	1X41063
1X50008	1X50058	1X50108	1X50158	1X50208	1X50262	1X50313
1X40058	1X40208	1X40358	1X40508	1X40658	1X41013	1X41064
1X50009	1X50059	1X50109	1X50159	1X50209	1X50263	1X50314
1X40101	1X40251	1X40401	1X40551	1X40701	—	—
1X50003	1X50053	1X50103	1X50153	1X50203	—	—
1X40102	1X40252	1X40402	1X40552	1X40702	1X41031	1X41086
1X50004	1X50054	1X50104	1X50154	1X50204	1X50252	1X50303
1X40103	1X40253	1X40403	1X40553	1X40703	1X41033	1X41088
1X50005	1X50055	1X50105	1X50155	1X50205	1X50255	1X50306
1X40104	1X40254	1X40404	1X40554	1X40704	1X41036	1X41091
1X50006	1X50056	1X50106	1X50156	1X50206	1X50259	1X50310
1X40105	1X40255	1X40405	1X40555	1X40705	1X41037	1X41092
1X50007	1X50057	1X50107	1X50157	1X50207	1X50260	1X50311
1X40106	1X40256	1X40406	1X40556	1X40706	1X41039	1X41094
1X50008	1X50058	1X50108	1X50158	1X50208	1X50262	1X50313
1X40107	1X40257	1X40407	1X40557	1X40707	1X41040	1X41095
1X50009	1X50059	1X50109	1X50159	1X50209	1X50263	1X50314

Per avere il codice completo inserire al posto della "X" i seguenti numeri:

0: Zincato Sendzimir - 1: Verniciato blu - 2: Verniciato grigio RAL 7035 - 4: Acciaio Inox AISI 304 - 7: Zincato a caldo.

To get the complete code to insert in place of "X" the following numbers:

0: Sendzimir galvanized steel - 1: Painted blue colour - 2: Painted gray RAL 7035 colour - 4: Stainless steel AISI 304 - 7: Hot-dip galvanized steel.

S5 SISTEMA DI PASSERELLE E CANALI AD INCASTRO

CABLE TRAYS AND CABLE TRUNKINGS SYSTEM WITH SLIDE IN

GUIDA ALLA SCELTA LINEA S5 / GUIDE FOR CHOOSING THE S5 LINE

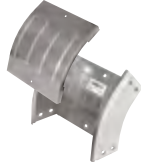
Accessori / Accessories		Raccordo di riduzione sinistra Left-hand reducer	Elemento di riduzione Reduction element	Curva in salita a 45° 45° rising elbow	Curva in salita a 90° 90° rising elbow	Curva in discesa a 45° 45° falling elbow	Curva in discesa a 90° 90° falling elbow
							
Dimensioni B x H / Dimensions B x H		Corpo / Code	Corpo / Code	Corpo / Code	Corpo / Code	Corpo / Code	Corpo / Code
50 x 50	Corpo / Body	—	—	1X41151	1X41301	1X41451	1X41601
	Coperchio / Cover	—	—	1X50401	1X50451	1X50501	1X50551
100 x 50	Corpo / Body	—	1X40962	1X41153	1X41303	1X41453	1X41603
	Coperchio / Cover	—	—	1X50403	1X50453	1X50483	1X50533
150 x 50	Corpo / Body	1X41121	1X40963	1X41154	1X41304	1X41454	1X41604
	Coperchio / Cover	1X50353	—	1X50404	1X50454	1X50484	1X50534
200 x 50	Corpo / Body	1X41123	1X40964	1X41155	1X41305	1X41455	1X41605
	Coperchio / Cover	1X50356	—	1X50405	1X50455	1X50485	1X50535
300 x 50	Corpo / Body	1X41126	1X40965	1X41156	1X41306	1X41456	1X41606
	Coperchio / Cover	1X50360	—	1X50406	1X50456	1X50486	1X50536
400 x 50	Corpo / Body	1X41127	—	1X41157	1X41307	1X41457	1X41607
	Coperchio / Cover	1X50361	—	1X50407	1X50457	1X50487	1X50537
500 x 50	Corpo / Body	1X41129	—	1X41158	1X41308	1X41458	1X41608
	Coperchio / Cover	1X50363	—	1X50408	1X50458	1X50488	1X50538
600 x 50	Corpo / Body	1X41130	—	1X41159	1X41309	1X41459	1X41609
	Coperchio / Cover	1X50364	—	1X50409	1X50459	1X50489	1X50539
80 x 80	Corpo / Body	—	—	1X41201	1X41351	1X41501	1X41651
	Coperchio / Cover	—	—	1X50402	1X50452	1X50502	1X50552
100 x 80	Corpo / Body	—	1X40968	1X41202	1X41352	1X41502	1X41652
	Coperchio / Cover	—	—	1X50403	1X50453	1X50503	1X50553
150 x 80	Corpo / Body	1X41102 - 1X41103	1X40969	1X41203	1X41353	1X41503	1X41653
	Coperchio / Cover	1X50352 - 1X50353	—	1X50404	1X50454	1X50504	1X50554
200 x 80	Corpo / Body	1X41106	1X40970	1X41204	1X41354	1X41504	1X41654
	Coperchio / Cover	1X50356	—	1X50405	1X50455	1X50505	1X50555
300 x 80	Corpo / Body	1X41110	1X40971	1X41205	1X41355	1X41505	1X41655
	Coperchio / Cover	1X50360	—	1X50406	1X50456	1X50506	1X50556
400 x 80	Corpo / Body	1X41111	—	1X41206	1X41356	1X41506	1X41656
	Coperchio / Cover	1X50361	—	1X50407	1X50457	1X50507	1X50557
500 x 80	Corpo / Body	1X41113	—	1X41207	1X41357	1X41507	1X41657
	Coperchio / Cover	1X50363	—	1X50408	1X50458	1X50508	1X50558
600 x 80	Corpo / Body	1X41114	—	1X41208	1X41358	1X41508	1X41658
	Coperchio / Cover	1X50364	—	1X50409	1X50459	1X50509	1X50559
100 x 100	Corpo / Body	—	—	1X41251	1X41401	1X41551	1X41701
	Coperchio / Cover	—	—	1X50403	1X50453	1X50521	1X50541
150 x 100	Corpo / Body	1X41136	1X40974	1X41252	1X41402	1X41552	1X41702
	Coperchio / Cover	1X50353	—	1X50404	1X50454	1X50522	1X50542
200 x 100	Corpo / Body	1X41138	1X40975	1X41253	1X41403	1X41553	1X41703
	Coperchio / Cover	1X50356	—	1X50405	1X50455	1X50523	1X50543
300 x 100	Corpo / Body	1X41141	1X40976	1X41254	1X41404	1X41554	1X41704
	Coperchio / Cover	1X50360	—	1X50406	1X50456	1X50524	1X50544
400 x 100	Corpo / Body	1X41142	1X40977	1X41255	1X41405	1X41555	1X41705
	Coperchio / Cover	1X50361	—	1X50407	1X50457	1X50525	1X50545
500 x 100	Corpo / Body	1X41144	—	1X41256	1X41406	1X41556	1X41706
	Coperchio / Cover	1X50363	—	1X50408	1X50458	1X50526	1X50546
600 x 100	Corpo / Body	1X41145	—	1X41257	1X41407	1X41557	1X41707
	Coperchio / Cover	1X50364	—	1X50409	1X50459	1X50527	1X50547





Per avere il codice completo inserire al posto della "X" i seguenti numeri:

0: Zincato Sendzimir - 1: Verniciato blu - 2: Verniciato grigio RAL 7035 - 4: Acciaio Inox AISI 304 - 7: Zincato a caldo.

To get the complete code to insert in place of "X" the following numbers:

0: Sendzimir galvanized steel - 1: Painted blue colour - 2: Painted gray RAL 7035 colour - 4: Stainless steel AISI 304 - 7: Hot-dip galvanized steel.

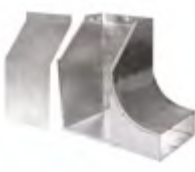
GUIDA ALLA SCELTA LINEA S5 / GUIDE FOR CHOOSING THE S5 LINE

Curva in discesa 90° con inversione piano 90° falling elbow with plane inversion	Curva in discesa 90° sghemba destra 90° skew right falling elbow	Curva in discesa 90° sghemba sinistra 90° skew left falling elbow	Curva in salita 90° sghemba destra 90° skew right rising elbow	Curva in salita 90° sghemba sinistra 90° skew left rising elbow
				
Codice / Code	Codice / Code	Codice / Code	Codice / Code	Codice / Code
—	—	—	—	—
—	—	—	—	—
—	—	—	—	—
—	—	—	—	—
—	—	—	—	—
—	—	—	—	—
—	—	—	—	—
—	—	—	—	—
—	—	—	—	—
1X41801	1X41951	1X42101	1X42202	1X42302
1X41802	1X41952	1X42102	1X42203	1X42303
1X41803	1X41953	1X42103	1X42204	1X42304
1X41804	1X41954	1X42104	1X42205	1X42305
1X41805	1X41955	1X42105	1X42206	1X42306
1X41806	1X41956	1X42106	1X42207	1X42307
1X41807	1X41957	1X42107	1X42208	1X42308
1X41808	1X41958	1X42108	1X42209	1X42309
1X41851	1X42001	1X42151	1X42251	1X42351
1X41852	1X42002	1X42152	1X42252	1X42352
1X41853	1X42003	1X42153	1X42253	1X42353
1X41854	1X42004	1X42154	1X42254	1X42354
1X41855	1X42005	1X42155	1X42255	1X42355
1X41856	1X42006	1X42156	1X42256	1X42356
1X41857	1X42007	1X42157	1X42257	1X42357

Per avere il codice completo inserire al posto della "X" i seguenti numeri:
 0: Zincato Sendzimir - 1: Verniciato blu - 2: Verniciato grigio RAL 7035 - 4: Acciaio Inox AISI 304 - 7: Zincato a caldo.
 To get the complete code to insert in place of "X" the following numbers:
 0: Sendzimir galvanized steel - 1: Painted blue colour - 2: Painted gray RAL 7035 colour - 4: Stainless steel AISI 304 - 7: Hot-dip galvanized steel.

GUIDA ALLA SCELTA LINEA S5 / GUIDE FOR CHOOSING THE S5 LINE

Accessori / Accessories		"T" in discesa Falling tee	"T" in discesa sghemba Skew falling tee	"T" in salita Rising tee	"T" in salita sghemba Skew rising tee	"T" in salita a coperchio Rising tee as cover	"T" in salita sghemba a coperchio Skew rising tee as cover
Lunghezza / Length							
Dimensioni B x H / Dimensions B x H		Codice / Code	Codice / Code	Codice / Code	Codice / Code	Codice / Code	Codice / Code
50 x 50	Corpo / Body	—	—	—	—	—	—
	Coperchio / Cover	—	—	—	—	—	—
100 x 50	Corpo / Body	—	—	—	—	—	—
	Coperchio / Cover	—	—	—	—	—	—
150 x 50	Corpo / Body	—	—	—	—	—	—
	Coperchio / Cover	—	—	—	—	—	—
200 x 50	Corpo / Body	—	—	—	—	—	—
	Coperchio / Cover	—	—	—	—	—	—
300 x 50	Corpo / Body	—	—	—	—	—	—
	Coperchio / Cover	—	—	—	—	—	—
400 x 50	Corpo / Body	—	—	—	—	—	—
	Coperchio / Cover	—	—	—	—	—	—
500 x 50	Corpo / Body	—	—	—	—	—	—
	Coperchio / Cover	—	—	—	—	—	—
600 x 50	Corpo / Body	—	—	—	—	—	—
	Coperchio / Cover	—	—	—	—	—	—
80 x 80	Corpo / Body	1X42452	1X42552	1X42652	1X42802	—	—
	Coperchio / Cover	—	—	—	—	—	—
100 x 80	Corpo / Body	1X42453	1X42553	1X42653	1X42803	1X42702	1X42852
	Coperchio / Cover	—	—	—	—	—	—
150 x 80	Corpo / Body	1X42454	1X42554	1X42654	1X42804	1X42703	1X42853
	Coperchio / Cover	—	—	—	—	—	—
200 x 80	Corpo / Body	1X42455	1X42555	1X42655	1X42805	1X42704	1X42854
	Coperchio / Cover	—	—	—	—	—	—
300 x 80	Corpo / Body	1X42456	1X42556	1X42656	1X42806	1X42705	1X42855
	Coperchio / Cover	—	—	—	—	—	—
400 x 80	Corpo / Body	1X42457	1X42557	1X42657	1X42807	1X42706	1X42856
	Coperchio / Cover	—	—	—	—	—	—
500 x 80	Corpo / Body	1X42458	1X42558	1X42658	1X42808	1X42707	1X42857
	Coperchio / Cover	—	—	—	—	—	—
600 x 80	Corpo / Body	1X42459	1X42559	1X42659	1X42809	—	—
	Coperchio / Cover	—	—	—	—	—	—
100 x 100	Corpo / Body	1X42501	1X42601	1X42751	1X42901	—	—
	Coperchio / Cover	—	—	—	—	—	—
150 x 100	Corpo / Body	1X42502	1X42602	1X42752	1X42902	—	—
	Coperchio / Cover	—	—	—	—	—	—
200 x 100	Corpo / Body	1X42503	1X42603	1X42753	1X42903	—	—
	Coperchio / Cover	—	—	—	—	—	—
300 x 100	Corpo / Body	1X42504	1X42604	1X42754	1X42904	—	—
	Coperchio / Cover	—	—	—	—	—	—
400 x 100	Corpo / Body	1X42505	1X42605	1X42755	1X42905	—	—
	Coperchio / Cover	—	—	—	—	—	—
500 x 100	Corpo / Body	1X42506	1X42606	1X42756	1X42906	—	—
	Coperchio / Cover	—	—	—	—	—	—
600 x 100	Corpo / Body	1X42507	1X42607	1X42757	1X42907	—	—
	Coperchio / Cover	—	—	—	—	—	—

Per avere il codice completo inserire al posto della "X" i seguenti numeri:

0: Zincato Sendzimir - 1: Verniciato blu - 2: Verniciato grigio RAL 7035 - 4: Acciaio Inox AISI 304 - 7: Zincato a caldo.

To get the complete code to insert in place of "X" the following numbers:

0: Sendzimir galvanized steel - 1: Painted blue colour - 2: Painted gray RAL 7035 colour - 4: Stainless steel AISI 304 - 7: Hot-dip galvanized steel.

GUIDA ALLA SCELTA LINEA S5 / GUIDE FOR CHOOSING THE S5 LINE

Testata di chiusura <i>End cap</i>	Flangia di raccordo <i>Connection flange</i>	Giunto lineare <i>Joint plate</i>	Giunto a snodo orizzontale <i>Articulated horizontal joint</i>	Giunto a snodo verticale <i>Articulated vertical joint</i>			Coprigiunto per coperchio <i>Joint for cover</i>	Coprigiunto per base <i>Joint for base</i>
Codice / Code	Codice / Code	Codice / Code	Codice / Code	ZS	ZF	IX	Codice / Code	Codice / Code
1X43101	1X43251	1X43401	1X43451	1043501	1743501	1443501	1X43551	1X43601
1X43103	1X43252	1X43401	1X43451	1043501	1743501	1443501	1X43553	1X43603
1X43104	1X43253	1X43401	1X43451	1043501	1743501	1443501	1X43554	1X43604
1X43105	1X43254	1X43401	1X43451	1043501	1743501	1443501	1X43555	1X43605
1X43106	1X43255	1X43401	1X43451	1043501	1743501	1443501	1X43556	1X43606
1X43107	1X43256	1X43401	1X43451	1043501	1743501	1443501	1X43557	1X43607
1X43108	1X43257	1X43401	1X43451	1043501	1743501	1443501	1X43558	1X43608
1X43109	1X43258	1X43401	1X43451	1043501	1743501	1443501	1X43559	1X43609
1X43151	1X43301	1X43403	1X43453	1043503	1743503	1443503	1X43552	1X43602
1X43152	1X43302	1X43403	1X43453	1043503	1743503	1443503	1X43553	1X43603
1X43153	1X43303	1X43403	1X43453	1043503	1743503	1443503	1X43554	1X43604
1X43154	1X43304	1X43403	1X43453	1043503	1743503	1443503	1X43555	1X43605
1X43155	1X43305	1X43403	1X43453	1043503	1743503	1443503	1X43556	1X43606
1X43156	1X43306	1X43403	1X43453	1043503	1743503	1443503	1X43557	1X43607
1X43157	1X43307	1X43403	1X43453	1043503	1743503	1443503	1X43558	1X43608
1X43158	1X43308	1X43403	1X43453	1043503	1743503	1443503	1X43559	1X43609
1X43201	1X43321	1X43405	1X43455	1519004	1529004	1443505	1X43553	1X43603
1X43202	1X43322	1X43405	1X43455	1519004	1529004	1443505	1X43554	1X43604
1X43203	1X43323	1X43405	1X43455	1519004	1529004	1443505	1X43555	1X43605
1X43204	1X43324	1X43405	1X43455	1519004	1529004	1443505	1X43556	1X43606
1X43205	1X43325	1X43405	1X43455	1519004	1529004	1443505	1X43557	1X43607
1X43206	1X43326	1X43405	1X43455	1519004	1529004	1443505	1X43558	1X43608
1X43207	1X43327	1X43405	1X43455	1519004	1529004	1443505	1X43559	1X43609





Per avere il codice completo inserire al posto della "X" i seguenti numeri:

0: Zincato Sendzimir - 1: Verniciato blu - 2: Verniciato grigio RAL 7035 - 4: Acciaio Inox AISI 304 - 7: Zincato a caldo.

To get the complete code to insert in place of "X" the following numbers:

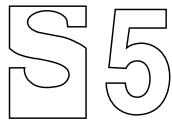
0: Sendzimir galvanized steel - 1: Painted blue colour - 2: Painted gray RAL 7035 colour - 4: Stainless steel AISI 304 - 7: Hot-dip galvanized steel.

GUIDA ALLA SCELTA LINEA S5 / GUIDE FOR CHOOSING THE S5 LINE

Accessori / Accessories		Separatore Divider		Staffa distanziatrice Spacer bracket					"KIT" di protezione IP 44 IP 44 protection "KIT"
		3000	2000	ZS	VB	VG	ZF	IX	
									
Dimensioni B x H / Dimensions B x H		Codice / Code		ZS	VB	VG	ZF	IX	Codice / Code
50 x 50	Corpo / Body	1X43055	1X43051	—	—	—	—	—	1X43851
	Coperchio / Cover								
100 x 50	Corpo / Body	1X43055	1X43051	1620401	1143802	1243802	1640401	1670401	—
	Coperchio / Cover								
150 x 50	Corpo / Body	1X43055	1X43051	1620402	1143803	1243803	1640402	1670402	—
	Coperchio / Cover								
200 x 50	Corpo / Body	1X43055	1X43051	1620403	1143804	1243804	1640403	1670403	—
	Coperchio / Cover								
300 x 50	Corpo / Body	1X43055	1X43051	1620404	1143805	1243805	1640404	1670404	—
	Coperchio / Cover								
400 x 50	Corpo / Body	1X43055	1X43051	1620405	1143806	1243806	1640405	1670405	—
	Coperchio / Cover								
500 x 50	Corpo / Body	1X43055	1X43051	1620406	1143807	1243807	1640406	1670406	—
	Coperchio / Cover								
600 x 50	Corpo / Body	1X43055	1X43051	—	—	—	—	—	—
	Coperchio / Cover								
80 x 80	Corpo / Body	1X43056	1X43052	—	—	—	—	—	1X43901
	Coperchio / Cover								
100 x 80	Corpo / Body	1X43056	1X43052	1620401	1143802	1243802	1640401	1670401	1X43902
	Coperchio / Cover								
150 x 80	Corpo / Body	1X43056	1X43052	1620402	1143803	1243803	1640402	1670402	1X43903
	Coperchio / Cover								
200 x 80	Corpo / Body	1X43056	1X43052	1620403	1143804	1243804	1640403	1670403	1X43904
	Coperchio / Cover								
300 x 80	Corpo / Body	1X43056	1X43052	1620404	1143805	1243805	1640404	1670404	1X43905
	Coperchio / Cover								
400 x 80	Corpo / Body	1X43056	1X43052	1620405	1143806	1243806	1640405	1670405	—
	Coperchio / Cover								
500 x 80	Corpo / Body	1X43056	1X43052	1620406	1143807	1243807	1640406	1670406	—
	Coperchio / Cover								
600 x 80	Corpo / Body	1X43056	1X43052	—	—	—	—	—	—
	Coperchio / Cover								
100 x 100	Corpo / Body	1X43057	—	1620401	1143802	1243802	1640401	1670401	—
	Coperchio / Cover								
150 x 100	Corpo / Body	1X43057	—	1620402	1143803	1243803	1640402	1670402	—
	Coperchio / Cover								
200 x 100	Corpo / Body	1X43057	—	1620403	1143804	1243804	1640403	1670403	—
	Coperchio / Cover								
300 x 100	Corpo / Body	1X43057	—	1620404	1143805	1243805	1640404	1670404	—
	Coperchio / Cover								
400 x 100	Corpo / Body	1X43057	—	1620405	1143806	1243806	1640405	1670405	—
	Coperchio / Cover								
500 x 100	Corpo / Body	1X43057	—	1620406	1143807	1243807	1640406	1670406	—
	Coperchio / Cover								
600 x 100	Corpo / Body	1X43057	—	—	—	—	—	—	—
	Coperchio / Cover								



Per avere il codice completo inserire al posto della "X" i seguenti numeri:

0: Zincato Sendzimir - 1: Verniciato blu - 2: Verniciato grigio RAL 7035 - 4: Acciaio Inox AISI 304 - 7: Zincato a caldo.

To get the complete code to insert in place of "X" the following numbers:

0: Sendzimir galvanized steel - 1: Painted blue colour - 2: Painted gray RAL 7035 colour - 4: Stainless steel AISI 304 - 7: Hot-dip galvanized steel.

GUIDA ALLA SCELTA LINEA S5 / GUIDE FOR CHOOSING THE S5 LINE





Piastrina fissacavi <i>Fixing cable plate</i>	Piastrina di terra per collegamenti equipotenziali <i>Earthing plate for equipotential connection</i>	Piastrina blocca coperchio <i>Fixing cover plate</i>	
			
Codice / Code	Codice / Code	ZS	IX
1X43801	1043971	1043572	1539001

Per avere il codice completo inserire al posto della "X" i seguenti numeri:



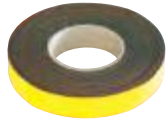

0: Zincato Sendzimir - 1: Verniciato blu - 2: Verniciato grigio RAL 7035.

To get the complete code to insert in place of "X" the following numbers:

0: Sendzimir galvanized steel - 1: Painted blue colour - 2: Painted gray RAL 7035 colour.

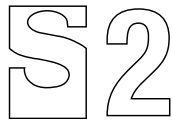
Giunto universale <i>Universal joint</i>	Vernice per ritocchi <i>Paint for repairing</i>		Vernice allo zinco <i>Zinc paint</i>	Guarnizione autoadesiva <i>Self-adhesive seal</i>
				
Codice / Code	VB	VG	ZF	Codice / Code
	1143981	1243981	1043981	1043951

GUIDA ALLA SCELTA LINEA S2 / GUIDE FOR CHOOSING THE S2 LINE

Elemento rettilineo / Straight element		Passerella a Filo Mesh wire cable tray			Separatore Divider	Curva piana a 90° 90° Horizontal elbow	
Lunghezza / Length		3000			3000		
							
Dimensioni B x H / Dimensions B x H		ZE	ZF	IX	Codice / Code	ZE	ZF
100 x 35	Corpo / Body	1611021	1641021	1671021	—	—	—
	Coperchio / Cover	1030003	1730003	1430003			
150 x 35	Corpo / Body	1611022	1641022	1671022	—	—	—
	Coperchio / Cover	1030004	1730004	1430004			
200 x 35	Corpo / Body	1611023	1641023	1671023	—	—	—
	Coperchio / Cover	1030005	1730005	1043005			
300 x 35	Corpo / Body	1611024	1641024	1671024	—	—	—
	Coperchio / Cover	1030006	1730006	1430006			
50 x 55	Corpo / Body	1611007	1641007	1671050	1X43055	—	—
	Coperchio / Cover	1030001	1730001	1430001			
100 x 55	Corpo / Body	1611001	1641001	1671001	1X43055	1620001	1640111
	Coperchio / Cover	1030003	1730003	1430003			
150 x 55	Corpo / Body	1611002	1641002	1671002	1X43055	1620002	1640112
	Coperchio / Cover	1030004	1730004	1430004			
200 x 55	Corpo / Body	1611003	1641003	1671003	1X43055	1620003	1640113
	Coperchio / Cover	1030005	1730005	1430005			
300 x 55	Corpo / Body	1611004	1641004	1671004	1X43055	1620004	1640114
	Coperchio / Cover	1030006	1730006	1430006			
400 x 55	Corpo / Body	1611005	1641005	1671005	1X43055	1620005	1640115
	Coperchio / Cover	1030007	1730007	1430007			
500 x 55	Corpo / Body	1611006	1641006	1671006	1X43055	1620006	1640116
	Coperchio / Cover	1030008	1730008	1430008			
600 x 55	Corpo / Body	1611008	1641008	1671008	1X43055	—	—
	Coperchio / Cover	1030009	1730009	1430009			
100 x 75	Corpo / Body	1611031	1641031	1671031	1X43055	1620131	1640131
	Coperchio / Cover	1030003	1730003	1430003			
150 x 75	Corpo / Body	1611032	1641032	1671032	1X43055	1620132	1640132
	Coperchio / Cover	1030004	1730004	1430004			
200 x 75	Corpo / Body	1611033	1641033	1671033	1X43055	1620133	1640133
	Coperchio / Cover	1030005	1730005	1430005			
300 x 75	Corpo / Body	1611034	1641034	1671034	1X43055	1620134	1640134
	Coperchio / Cover	1030006	1730006	1430006			
400 x 75	Corpo / Body	1611035	1641035	1671035	1X43055	1620135	1640135
	Coperchio / Cover	1030007	1730007	1430007			
500 x 75	Corpo / Body	1611036	1641036	1671036	1X43055	1620136	1640136
	Coperchio / Cover	1030008	1730008	1430008			
600 x 75	Corpo / Body	1611037	1641037	1671037	1X43055	—	—
	Coperchio / Cover	1030009	1730009	1430009			
100 x 105	Corpo / Body	1611051	1641051	1671061	1X43057	1620111	1640011
	Coperchio / Cover	1030003	1730003	1430003			
150 x 105	Corpo / Body	1611052	1641052	1671052	1X43057	1620112	1640012
	Coperchio / Cover	1030004	1730004	1430004			
200 x 105	Corpo / Body	1611053	1641053	1671053	1X43057	1620113	1640013
	Coperchio / Cover	1030005	1730005	1430005			
300 x 105	Corpo / Body	1611054	1641054	1671054	1X43057	1620114	1640014
	Coperchio / Cover	1030006	1730006	1430006			
400 x 105	Corpo / Body	1611055	1641055	1671055	1X43057	1620115	1640015
	Coperchio / Cover	1030007	1730007	1430007			
500 x 105	Corpo / Body	1611056	1641056	1671056	1X43057	1620116	1640016
	Coperchio / Cover	1030008	1730008	1430008			
600 x 105	Corpo / Body	1611057	1641057	1671057	1X43057	—	—
	Coperchio / Cover	1030009	1730009	1430009			





Per avere il codice completo inserire al posto della "X" i seguenti numeri:

0: Zincato Sendzimir - 4: Acciaio Inox AISI 304 - 7: Zincato a caldo.



To get the complete code to insert in place of "X" the following numbers:





0: Sendzimir galvanized steel - 4: Stainless steel AISI 304 - 7: Hot-dip galvanized steel.





GUIDA ALLA SCELTA LINEA S2 / GUIDE FOR CHOOSING THE S2 LINE



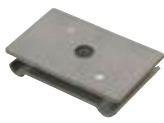

Morsetto di giunzione lineare <i>Junction plate clamp</i>			Morsetto di giunzione snodabile <i>Articulated joint clamp</i>		Supporto per scatola di derivazione <i>Boxes fixing support</i>		Morsetto di fissaggio della passerella alla mensola <i>Fixing clamp for mesh wire cable trays on bracket</i>			Morsetto GKS 50 <i>Clamps GKS 50</i>
										
ZE	ZF	IX	ZF	IX	ZS	IX	ZE	ZF	IX	ZS
1620052	1620051	1670051	1620101	1670101	—	—	1620162	1620152	1670152	1620351
1620052	1620051	1670051	1620101	1670101	—	—	1620162	1620152	1670152	1620351
1620052	1620051	1670051	1620101	1670101	—	—	1620162	1620152	1670152	1620351
1620052	1620051	1670051	1620101	1670101	—	—	1620162	1620152	1670152	1620351
1620052	1620051	1670051	1620101	1670101	1620452	1670452	1620162	1620152	1670152	1620351
1620052	1620051	1670051	1620101	1670101	1620452	1670452	1620162	1620152	1670152	1620351
1620052	1620051	1670051	1620101	1670101	1620452	1670452	1620162	1620152	1670152	1620351
1620052	1620051	1670051	1620101	1670101	1620452	1670452	1620162	1620152	1670152	1620351
1620052	1620051	1670051	1620101	1670101	1620452	1670452	1620162	1620152	1670152	1620351
1620052	1620051	1670051	1620101	1670101	1620452	1670452	1620162	1620152	1670152	1620351
1620052	1620051	1670051	1620101	1670101	1620452	1670452	1620162	1620152	1670152	1620351
1620052	1620051	1670051	1620101	1670101	1620452	1670452	1620162	1620152	1670152	1620351
1620052	1620051	1670051	1620101	1670101	1620452	1670452	1620162	1620152	1670152	1620351
1620052	1620051	1670051	1620101	1670101	1620452	1670452	1620162	1620152	1670152	1620351
1620052	1620051	1670051	1620101	1670101	1620452	1670452	1620162	1620152	1670152	1620351
1620052	1620051	1670051	1620101	1670101	1620452	1670452	1620162	1620152	1670152	1620351
1620052	1620051	1670051	1620101	1670101	1620452	1670452	1620162	1620152	1670152	1620351
1620052	1620051	1670051	1620101	1670101	1620452	1670452	1620162	1620152	1670152	1620351
1620052	1620051	1670051	1620101	1670101	1620452	1670452	1620162	1620152	1670152	1620351
1620052	1620051	1670051	1620101	1670101	1620452	1670452	1620162	1620152	1670152	1620351
1620052	1620051	1670051	1620101	1670101	1620452	1670452	1620162	1620152	1670152	1620351
1620052	1620051	1670051	1620101	1670101	1620452	1670452	1620162	1620152	1670152	1620351
1620052	1620051	1670051	1620101	1670101	1620452	1670452	1620162	1620152	1670152	1620351
1620052	1620051	1670051	1620101	1670101	1620452	1670452	1620162	1620152	1670152	1620351

GUIDA ALLA SCELTA LINEA S2 / GUIDE FOR CHOOSING THE S2 LINE







Accessori / Accessories	Giunto rapido lineare Linear quick joint			Giunto di Rinforzo Joint Reinforcement		
						
Dimensioni B x H / Dimensions B x H	ZE	ZF	IX	ZE	IX	ZF
	1620155	1640155	1670155	1621155	1641155	1671155

Accessori / Accessories	Staffa Fissaggio a Soffitto K6/101 Ceiling Bracket K6/101			Profilato AP U Section AP			Gaffa di Sospensione K 109 Floor clamp K 109	
								
Dimensioni B x H / Dimensions B x H	ZS	ZF	IX	ZS	ZF	IX	ZF	IX
	1663101	1620201	1670201	1665000	1645000	1675000	1620251	1670251

Accessori / Accessories	Staffa Fissaggio a Parete K 12 Wall Clamp K 12		Supporto Laterale Lateral Support	Morsetto Sospensione Hanging clamp	Supporto a Soffitto TPS Lateral Support			
Lunghezza / Length					445	545	645	
								
Dimensioni B x H / Dimensions B x H	ZS	IX	ZE	Codice / Code		ZS		
	1620352	1670352	1620353	M 6	1620301	1664445	1664545	1664645
				M 8	1620302			
				M 10	1620303			

Accessori / Accessories	Morsetto di Terra Earth Terminal	Barra Filettata per Sospensione AS Threaded rod AS	Manicotto di Prolunga MA Rod Coupling AM	Cesoia Shear					
Lunghezza / Length		1000							
									
Dimensioni B x H / Dimensions B x H	Codice / Code		ZE	IX	ZE	IX	Codice / Code		
	1620310		M 6	2020301	2420301	M 6	2020351	2420351	1665003
			M 8	2020302	2420302	M 8	2020352	2420352	
			M 10	2020303	2420303	M 10	2020353	2420353	

GUIDA ALLA SCELTA LINEA S2 / GUIDE FOR CHOOSING THE S2 LINE

Accessori / Accessories		Mensola ad Incastro Interlocking bracket	Mensola Rapida AWG Rapid bracket		Staffa distanziatrice rapida Spacer bracket	Staffa distanziatrice Spacer bracket	Profilo ad Incastro "U" Section Interlocking
							
Dimensioni B x H / Dimensions B x H		ZE	ZF	ZF	ZS	Codice / Code	Codice / Code
100 x 35	Corpo / Body	1620501	1661110	—	1662100	16X0401	16X0621
	Coperchio / Cover						
150 x 35	Corpo / Body	1620502	1661160	—	—	16X0402	16X0622
	Coperchio / Cover						
200 x 35	Corpo / Body	1620503	1661210	—	1662200	16X0403	16X0623
	Coperchio / Cover						
300 x 35	Corpo / Body	1620504	1661310	—	1662300	16X0404	16X0624
	Coperchio / Cover						
50 x 55	Corpo / Body	1620501	1661110	—	—	16X0401	16X0621
	Coperchio / Cover						
100 x 55	Corpo / Body	1620501	1661110	—	1662100	16X0401	16X0621
	Coperchio / Cover						
150 x 55	Corpo / Body	1620502	1661160	—	—	16X0402	16X0622
	Coperchio / Cover						
200 x 55	Corpo / Body	1620503	1661210	—	1662200	16X0403	16X0623
	Coperchio / Cover						
300 x 55	Corpo / Body	1620504	1661310	—	1662300	16X0404	16X0624
	Coperchio / Cover						
400 x 55	Corpo / Body	—	—	1661410	1662400	16X0405	16X0625
	Coperchio / Cover						
500 x 55	Corpo / Body	—	—	1661510	—	16X0406	16X0626
	Coperchio / Cover						
600 x 55	Corpo / Body	—	—	1661610	—	—	16X0627
	Coperchio / Cover						
100 x 75	Corpo / Body	1620501	1661110	—	1662100	16X0401	16X0621
	Coperchio / Cover						
150 x 75	Corpo / Body	1620502	1661160	—	—	16X0402	16X0622
	Coperchio / Cover						
200 x 75	Corpo / Body	1620503	1661210	—	1662200	16X0403	16X0623
	Coperchio / Cover						
300 x 75	Corpo / Body	1620504	1661310	—	1662300	16X0404	16X0624
	Coperchio / Cover						
400 x 75	Corpo / Body	—	—	1661410	1662400	16X0405	16X0625
	Coperchio / Cover						
500 x 75	Corpo / Body	—	—	1661510	—	16X0406	16X0626
	Coperchio / Cover						
600 x 75	Corpo / Body	—	—	1661610	—	—	16X0627
	Coperchio / Cover						
100 x 105	Corpo / Body	1620501	1661110	—	1662100	16X0401	16X0621
	Coperchio / Cover						
150 x 105	Corpo / Body	1620502	1661160	—	—	16X0402	16X0622
	Coperchio / Cover						
200 x 105	Corpo / Body	1620503	1661210	—	1662200	16X0403	16X0623
	Coperchio / Cover						
300 x 105	Corpo / Body	1620504	1661310	—	1662300	16X0404	16X0624
	Coperchio / Cover						
400 x 105	Corpo / Body	—	—	1661410	1662400	16X0405	16X0625
	Coperchio / Cover						
500 x 105	Corpo / Body	—	—	1661510	—	—	16X0626
	Coperchio / Cover						
600 x 105	Corpo / Body	—	—	1661610	—	—	16X0627
	Coperchio / Cover						

Per avere il codice completo inserire al posto della "X" i seguenti numeri: 5: Zincato Sendzimir - 7: Acciaio Inox AISI 304 - 4: Zincato a caldo.
To get the complete code to insert in place of "X" the following numbers: 0: Sendzimir galvanized steel - 4: Stainless steel AISI 304 - 7: Hot-dip galvanized steel.

GUIDA ALLA SCELTA LINEA S3 / GUIDE FOR CHOOSING THE S3 LINE

Elemento rettilineo / Straight element		Passerella Cable ladder		Longherone Side rail		Traversino Rung		
Lunghezza / Length		3000		3000				
Dimensioni B x H / Dimensions B x H		ZS	ZF		ZS	ZF	ZS	ZF
100 x 100	Corpo / Body	1511010	1521010	Destro / Right	1511330	1521330	1511410	1521410
	Coperchio / Cover							
200 x 100	Corpo / Body	1511020	1521020					
	Coperchio / Cover							
300 x 100	Corpo / Body	1511030	1521030					
	Coperchio / Cover							
400 x 100	Corpo / Body	1511040	1521040	Sinistro / Left	1511331	1521331	1511440	1521440
	Coperchio / Cover							
500 x 100	Corpo / Body	1511050	1521050					
	Coperchio / Cover							
600 x 100	Corpo / Body	1511060	1521060	1511460	1521460			
	Coperchio / Cover							

Accessori / Fittings		Derivazione piana a "T" Horizontal Tee		Derivazione piana a incrocio Horizontal cross		Curve snodate salita e discesa (0 - 90°) Articulated elbows rising and falling (0 - 90°)	
Dimensioni B x H / Dimensions B x H		ZS	ZF	ZS	ZF	ZS	ZF
100 x 100	Corpo / Body	1514010	1524010	1515010	1525010	1516010	1526010
	Coperchio / Cover	1514110	1524110	1515110	1525110	1516110	1526110
200 x 100	Corpo / Body	1514020	1524020	1515020	1525020	1516020	1526020
	Coperchio / Cover	1514120	1524120	1515120	1525120	1516120	1526120
300 x 100	Corpo / Body	1514030	1524030	1515030	1525030	1516030	1526030
	Coperchio / Cover	1514130	1524130	1515130	1525130	1516130	1526130
400 x 100	Corpo / Body	1514040	1524040	1515040	1525040	1516040	1526040
	Coperchio / Cover	1514140	1524140	1515140	1525140	1516140	1526140
500 x 100	Corpo / Body	1514050	1524050	1515050	1525050	1516050	1526050
	Coperchio / Cover	1514150	1524150	1515150	1525150	1516150	1526150
600 x 100	Corpo / Body	1514060	1524060	1515060	1525060	1516060	1526060
	Coperchio / Cover	1514160	1524160	1515160	1525160	1516160	1526160

Accessori / Fittings		Separatore Divider		Testata di chiusura End cap		Giunto lineare rettilineo Joint plate	
Lunghezza / Length		3000					
Dimensioni B x H / Dimensions B x H		ZS	ZF	ZS	ZF	ZS	ZF
100 x 100	Corpo / Body	1043056	1743056	1043201	1743201	1519002	1529002
200 x 100	Corpo / Body	1043056	1743056	1043203	1743203	1519002	1529002
300 x 100	Corpo / Body	1043056	1743056	1043204	1743204	1519002	1529002
400 x 100	Corpo / Body	1043056	1743056	1043205	1743205	1519002	1529002
500 x 100	Corpo / Body	1043056	1743056	1043206	1743206	1519002	1529002
600 x 100	Corpo / Body	1043056	1743056	1043207	1743207	1519002	1529002

GUIDA ALLA SCELTA LINEA S3 / GUIDE FOR CHOOSING THE S3 LINE

Coperchio Cover		Coperchio a tegolino Special cover		Curva piana 45° 45° horizontal elbow		Curva piana 90° 90° horizontal elbow	
3000		3000					
ZS	ZF	ZS	ZF	ZS	ZF	ZS	ZF
1030003	1730003	1511210	1521210	1513010	1523010	1512010	1522010
				1513110	1523110	1512110	1522110
1030005	1730005	1511220	1521220	1513020	1523020	1512020	1522020
				1513120	1523120	1512120	1522120
1030006	1730006	1511230	1521230	1513030	1523030	1512030	1522030
				1513130	1523130	1512130	1522130
1030007	1730007	1511240	1521240	1513040	1523040	1512040	1522040
				1513140	1523140	1512140	1522140
1030008	1730008	1511250	1521250	1513050	1523050	1512050	1522050
				1513150	1523150	1512150	1522150
1030009	1730009	1511260	1521260	1513060	1523060	1512060	1522060
				1513160	1523160	1512160	1522160





Raccordo di riduzione centrale Straight reducer		Raccordo di riduzione destra Right-hand reducer		Raccordo di riduzione sinistra Left-hand reducer		Giunto angolare Angular joint	
ZS	ZF	ZS	ZF	ZS	ZF	ZS	ZF
—	—	—	—	—	—	1519006	1529006
—	—	—	—	—	—		
1517020	1527020	1517022	1527022	1517021	1527021	1519006	1529006
1517120	1527120	1517122	1527122	1517121	1527121		
1517030	1527030	1517032	1527032	1517031	1527031	1519006	1529006
1517130	1527130	1517132	1527132	1517131	1527131		
1517040	1527040	1517042	1527042	1517041	1527041	1519006	1529006
1517140	1527140	1517142	1527142	1517141	1527141		
1517050	1527050	1517052	1527052	1517051	1527051	1519006	1529006
1517150	1527150	1517152	1527152	1517151	1527151		
1517060	1527060	1517062	1527062	1517061	1527061	1519006	1529006
1517160	1527160	1517162	1527162	1517161	1527161		





Giunto a snodo orizzontale Articulated horizontal joint		Giunto a snodo verticale Articulated vertical joint		Piastrina blocca coperchio Fixing cover plate		Piastrina di fissaggio Fixing plate		Piastrina di terra Earthing plate
ZS	ZF	ZS	ZF	ZS	IX	ZS	IX	Codice / Code
1519003	1529003	1519004	1529004	1043572	1539001	1519005	1539005	1043971
1519003	1529003	1519004	1529004	1043572	1539001	1519005	1539005	1043971
1519003	1529003	1519004	1529004	1043572	1539001	1519005	1539005	1043971
1519003	1529003	1519004	1529004	1043572	1539001	1519005	1539005	1043971
1519003	1529003	1519004	1529004	1043572	1539001	1519005	1539005	1043971
1519003	1529003	1519004	1529004	1043572	1539001	1519005	1539005	1043971

SISTEMA DI PASSERELLE E CANALI CALPESTABILI

CABLE TRAYS AND CABLE TRUNKINGS SYSTEM TRAMPLING

GUIDA ALLA SCELTA / GUIDE FOR CHOOSING



Elemento rettilineo / Straight element	Canalina asolata + Coperchio Slotted cable tray + Cover	Canalina asolata + Coperchio incernierato Slotted cable tray + Hinged cover	Canalina + Coperchio incernierato Cable tray + Hinged cover	Separatore Divider
Lunghezza / Length	2000	2000	2000	2000
				
Dimensioni B x H / Dimensions B x H	SZ	SZ	SZ	SZ
50 x 50	Corpo / Body	1920001	1920049	—
	Coperchio / Cover			—
100 x 100	Corpo / Body	1920002	1920060	1920410 / 1920412
	Coperchio / Cover			
200 x 100	Corpo / Body	1920003	1920061	1920410 / 1920412
	Coperchio / Cover			
300 x 100	Corpo / Body	1920004	1920062	1920410 / 1920412
	Coperchio / Cover			
200 x 150	Corpo / Body	—	1920064	—
	Coperchio / Cover			1920411 / 1920413
300 x 150	Corpo / Body	1920005	1920063	1920411 / 1920413
	Coperchio / Cover			
400 x 150	Corpo / Body	1920006	—	—
	Coperchio / Cover			1920411 / 1920413



Accessori / Fittings	Derivazione Laterale a "T" Lateral Outlet Tee	Giunto in Salita a 45° 45° Rising Joint	Giunto in Salita + Coperchio Rising Elbow + Cover	Giunto in Discesa a 45° 45° Falling Joint
				
Dimensioni B x H / Dimensions B x H	SZ	SZ	SZ	SZ
50 x 50	Corpo / Body	—	—	1920150
	Coperchio / Cover			—
100 x 100	Corpo / Body	1920350	1920504	1920151
	Coperchio / Cover			1920500
200 x 100	Corpo / Body	1920351	1920505	1920152
	Coperchio / Cover			1920501
300 x 100	Corpo / Body	1920352	1920506	1920153
	Coperchio / Cover			1920502
200 x 150	Corpo / Body	1920355	—	—
	Coperchio / Cover			—
300 x 150	Corpo / Body	1920353	1920507	1920154
	Coperchio / Cover			1920503
400 x 150	Corpo / Body	1920354	—	—
	Coperchio / Cover			—

SISTEMA DI PASSERELLE E CANALI CALPESTABILI



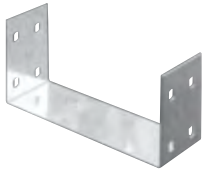





CABLE TRAYS AND CABLE TRUNKINGS SYSTEM TRAMPLING

GUIDA ALLA SCELTA / GUIDE FOR CHOOSING

Accessori / Fittings		Giunto in Discesa + Coperchio <i>Falling Elbow + Cover</i>	Chiusura di Testata <i>End Cap</i>	Flangia Uscita Laterale <i>Lateral Outlet Flange</i>	Giunto tra Canaline <i>Joint Among Cable Trays</i>
					
Dimensioni B x H / Dimensions B x H		SZ	SZ	SZ	SZ
50 x 50	Corpo / Body	1920100	1920450	1920300	1920200
	Coperchio / Cover				
100 x 100	Corpo / Body	1920101	1920451	1920301	1920201
	Coperchio / Cover				
200 x 100	Corpo / Body	1920102	1920452	1920302	1920202
	Coperchio / Cover				
300 x 100	Corpo / Body	1920103	1920453	1920303	1920203
	Coperchio / Cover				
200 x 150	Corpo / Body	—	1920456	—	—
	Coperchio / Cover				
300 x 150	Corpo / Body	1920104	1920454	1920304	1920204
	Coperchio / Cover				
400 x 150	Corpo / Body	—	1920455	—	1920205
	Coperchio / Cover				

Accessori / Fittings		Piastra Giunzione Canaline <i>Cable Trays Coupling Plate</i>	Piastra Giunzione Canaline 90° <i>90° Cable Trays Coupling Plate</i>	Piastra Giunzione Canaline 135° <i>135° Cable Trays Coupling Plate</i>
				
Dimensioni B x H / Dimensions B x H		SZ	SZ	SZ
50 x 50	Corpo / Body	1920250	1920253	—
	Coperchio / Cover			
100 x 100	Corpo / Body	1920251	1920254	1920256
	Coperchio / Cover			
200 x 100	Corpo / Body	1920251	1920254	1920256
	Coperchio / Cover			
300 x 100	Corpo / Body	1920251	1920254	1920256
	Coperchio / Cover			
200 x 150	Corpo / Body	1920252	1920255	1920257
	Coperchio / Cover			
300 x 150	Corpo / Body	1920252	1920255	1920257
	Coperchio / Cover			
400 x 150	Corpo / Body	1920252	1920255	1920257
	Coperchio / Cover			

GUIDA ALLA SCELTA SOSPENSIONI / GUIDE FOR CHOOSING THE SUPPORT DEVICES







Accessori / Accessories	Mensola ML Bracket ML	Base Mensola BM Base Bracket BM	Mensola Bracket	Mensola MP Bracket MP	Mensola MP Bracket MP	Mensola MPS Bracket MPS	Mensola Tunnel MT Tunnel Bracket MT	Mensola Doppia MPD Double Bracket MPD	Mensola Doppia MDB Tunnel Bracket MDB	
										
Per B / For B	Codice / Code	Codice / Code	ZF	ZF	IX	ZF	ZF	IX	ZF	Codice / Code
100	2Y10001	2Y10101	2510401	2510301	—	—	2510551	2410561	—	2Y10201
150	2Y10002	2Y10102	2510402	2510302	—	—	—	—	—	—
200	2Y10003	2Y10103	2510403	2510303	2410253	—	2510553	2410563	—	2Y10203
300	2Y10004	2Y10104	2510404	2510304	2410254	2510454	2510554	2410564	—	2Y10204
400	2Y10051	2Y10105	2510405	2510305	2410255	2510455	—	—	—	—
500	2Y10052	2Y10106	2510406	2510306	2410256	2510456	—	—	2510506	—
600	2Y10053	2Y10107	2510407	2510307	—	2510457	—	—	2510507	—
700	—	—	—	2510308	—	2510458	—	—	2510508	—
800	—	—	—	2510309	—	2510459	—	—	2510509	—
900	—	—	—	—	—	2510460	—	—	2510510	—
1000	—	—	—	—	—	2510461	—	—	2510511	—

Per avere il codice completo inserire al posto della "Y" i seguenti numeri:

0: Zincato Sendzimir - 1: Verniciato blu - 2: Verniciato grigio RAL 7035 - 4: Acciaio Inox AISI 304 - 5: Zincato a caldo.







To get the complete code to insert in place of "Y" the following numbers:

0: Sendzimir galvanized steel - 1: Painted blue colour - 2: Painted gray RAL 7035 colour - 4: Stainless steel AISI 304 - 5: Hot-dip galvanized steel.





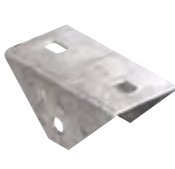

Accessori / Accessories	Profilo PSL "U" Section PSL	Profilo PSM "U" Section PSM	Profilo PRL "U" Section PRL	Profilo PRM "U" Section PRM	Profilo Doppio 82 x 41 Double Section 82 x 41	Profilo PSP "U" Section PSP	Profilo PRP "U" Section PRP
Lunghezza / Length	2000	2000	3000	3000	3000	3000	3000
Spessore / Thickness	1,5	2	2	2 1,5	2	3	2,5
Dimensione / Dimensions	40 x 28	40 x 28	41 x 21	41 x 41	41 x 82	50 x 40	50 x 40
							
Finitura / Finishing	Codice / Code	Codice / Code	Codice / Code	Codice / Code	Codice / Code	Codice / Code	Codice / Code
ZS	2020001	2020051	2020152	2020202	—	—	—
VB	2120001	2120051	—	—	—	—	—
VG	2220001	2220051	—	—	—	—	—
IX	2420001	2420051	—	—	2420204	—	—
ZF	2520001	2520051	2520152	2520202	—	2520210	2520451
Tappo per sospensione "U" section end cap	—	—	2030021	2030022	—	—	2030023



ZS: Zincato Sendzimir - VB: Verniciato blu - VG: Verniciato grigio RAL 7035 - IX: Acciaio Inox AISI 304 - ZF: Zincato a caldo.

ZS: Sendzimir galvanized steel - VB: Painted blue colour - VG: Painted gray RAL 7035 colour - IX: Stainless steel AISI 304 - ZF: Hot-dip galvanized steel.

Accessori / Accessories	Distanziatore per Profilo Spacer for "U" Section	Distanziatore per Profilo Spacer for "U" Section	Supporto Multiplo SML Ceiling Support SML	Supporto Regolabile SRP Adjustable Support SRP	Supporto Regolabile Adjustable Support	Supporto a Cerniera SCP Hinged Support SCP	Supporto Semplice SSM Ceiling Support SSM
Spessore / Thickness	2	3	2	2,5	2,5	2,5	Sp. Base 2,5 / Sp. Piede 2,5
							
Finitura / Finishing	Codice / Code	Codice / Code	Codice / Code	Codice / Code	Codice / Code	Codice / Code	Codice / Code
ZS	2030351	—	2030001	—	2030070	—	—
VB	2130351	—	2130001	—	—	—	2130051
VG	2230351	—	2230001	—	—	—	2230051
IX	—	—	2430001	—	2430070	—	2430051
ZF	—	2520502	2530001	2530053	2530070	2530054	2030051





GUIDA ALLA SCELTA SOSPENSIONI / GUIDE FOR CHOOSING THE SUPPORT DEVICES





Accessori / Accessories	Supporto Semplice SSML Ceiling Support SSML	Supporto Semplice SSP Ceiling Support SSP	Supporto Doppio SDP Ceiling Support SDP	Supporto Doppio 82 x 41 Ceiling Support 82 x 41	Supporto Tubolare SST Ceiling Pipe SST	Tubo per Sospensione TZ Ceiling Pipe Support TZ
Lunghezza / Length						3000
Spessore / Thickness	Sp. ^{Base} 2,5 / Sp. ^{Piede} 2	Sp. ^{Base} 4 / Sp. ^{Piede} 3	Sp. ^{Base} 4 / Sp. ^{Piede} 3	Sp. ^{Base} 10 / Sp. ^{Piede} 4		1
						
Finitura / Finishing	Codice / Code	Codice / Code	Codice / Code	Codice / Code	Codice / Code	Codice / Code
ZE	—	—	—	—	2030151	2020401
VB	—	—	—	—	2130151	2120401
VG	—	—	—	—	2230151	2220401
ZF	2030052	2530051	2530052	2530055	—	—

Accessori / Accessories	Staffa Tubolare SST Pipe Support SST	Staffa di Sostegno STS Bracket Support STS	Staffa a Plafone STP Ceiling Support STP
			
Per B / For B	Codice / Code	Codice / Code	Codice / Code
50	2Z30251	2Z30301	2Z30201
80	2Z30252	2Z30302	2Z30202
100	2Z30253	2Z30303	2Z30203
150	2Z30254	2Z30304	2Z30204
200	2Z30255	2Z30305	2Z30205
300	2Z30256	2Z30306	2Z30206
400	—	2Z30307	2Z30207
500	—	2Z30308	2Z30208





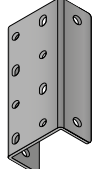

Accessori / Accessories	Bandella per Sospensione BA Hanging strip BA	
Lunghezza / Length	1000	2000
Spessore / Thickness	1,2	2
		
Finitura / Finishing	Codice / Code	Codice / Code
ZS	2020251	2020252
VB	2120251	2120252
VG	2220251	2220252

Per avere il codice completo inserire al posto della "Z" i seguenti numeri: 0: Zincato Sendzimir - 1: Verniciato blu - 2: Verniciato grigio RAL 7035.
To get the complete code to insert in place of "Z" the following numbers: 0: Sendzimir galvanized steel - 1: Painted blue colour - 2: Painted gray RAL 7035 colour.

Accessori / Accessories	Staffa Oscillante STO Beam clamp with swivel STO	Morsetto per trave Beam clamp STO	Barra Filettata per Sospensione AS Threaded rod AS	Manicotto di Prolunga MA Rod Coupling AM	
Lunghezza / Length			1000		
					
Filettatura / Thread	ZE	ZE	ZE	IX	ZE
M 6	—	2610505	2020301	2420301	2020351
M 8	—	2610504	2020302	2420302	2020352
M 10	2610501	2610508	2020303	2420303	2020353
M 12	—	2610509	2020304	2420304	2020354









Accessori / Accessories	Giunto per Profilo PSL/PSM Joint for "U" Section PSL/PSM	Giunto per Profilo PRL Joint for "U" Section PRL	Giunto per Profilo PRM Joint for "U" Section PRM	Giunto per Profilo 82 x 41 Joint for "U" Section 82 x 41	Giunto per Profilo PSP/PRP Joint for "U" Section PSP/PRP
					
Finitura / Finishing	Codice / Code	Codice / Code	Codice / Code		Codice / Code
ZE	2020101	2020153	2020203	—	—
VB	2120101	—	—	—	—
VG	2220101	—	—	—	—
IX	2420101	—	2420203	—	—
ZF	2520101	2520153	2520203	2520211	2520501

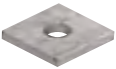







GUIDA ALLA SCELTA STRUTTURE COMPONIBILI / GUIDE FOR CHOOSING THE METAL FRAMING









Profilo / "U" Section	Profilo PRP "U" Section PRP	Giunto per Profilo PRP Joint for "U" Section PRP	Profilo PRL "U" Section PRL	Giunto per Profilo PRL Joint for "U" Section PRL	Profilo PRM "U" Section PRM	Giunto per Profilo PRM Joint for "U" Section PRM
Lunghezza / Length	3000		3000		3000	
Spessore / Thickness	2,5		2		2	
Dimensioni / Dimensions	50 x 40		41 x 21		41 x 41	
						
Finitura / Finishing	Codice / Code	Codice / Code	Codice / Code	Codice / Code	Codice / Code	Codice / Code
ZS	—	—	2020152	2020153	2020202	2020203
ZF	2520452	2520501	2520152	2520153	2520202	2520203









ZS: Zincato Sendzimir - ZF: Zincato a caldo.

ZS: Sendzimir galvanized steel - ZF: Hot-dip galvanized steel.







PR 101	PR 102	PR 103	PR 104	PR 105	PR 106	PR 107	PR 108
							
ZF	ZF	ZF	ZF	ZF	ZF	ZF	ZF
2610001	2610002	2610003	2610004	2610005	2610006	2610007	2610008

PR 109	PR 110	PR 124	PR 111	PR 112	PR 113	PR 114	PR 125
							
ZF	ZF	ZF	ZF	ZF	ZF	ZF	ZF
2610009	2610010	2610024	2610011	2610012	2610013	2610014	2610025



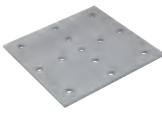

PR 126	PR 127	PR 128	PR 129	PR 115	PR 116	PR 132	PR 133
							
ZF	ZF	ZF	ZF	ZF	ZF	ZF	ZF
2610026	2610027	2610028	2610029	2610015	2610016	2610032	2610033

PR 134	PR 135	PR 137	PR 138	PR 136	PR 142	PR 139	PR 140
							
ZF	ZF	ZF	ZF	ZF	ZF	ZF	ZF
2610034	2610035	45° 2610037	45° 2610038	2610036	2610042	2610039	2610040
		25° 2610047	65° 2610051				
		30° 2610048	60° 2610052				
		35° 2610049	55° 2610053				

GUIDA ALLA SCELTA STRUTTURE COMPONENTI / GUIDE FOR CHOOSING THE METAL FRAMING

PR 143	PR 144	PR 145	PR 117 - PRP	PR 118 - PRM	PR 121 - PRP	PR 122 - PRM	PR 150
							
ZF	ZF	ZF	ZF	ZF	ZF	ZF	ZF
2610043	2610044	2610045	2610017	2610018	2610021	2610022	2610050

PR 119	PR 120	Tappo sospensione 50x40 50x40 "U" section end cap	Tappo sospensione 41x21 41x21 "U" section end cap	Tappo sospensione 41x41 41x21 "U" section end cap
				
ZF	ZF	Codice / Code	Codice / Code	Codice / Code
2610019	2610020	2030023	2030021	2030022

Accessori / Accessories	Staffa Oscillante STO Beam clamp with swivel STO	Morsetto per trave Beam clamp STO	Barra Filettata per Sospensione AS Threaded rod AS	Manicotto di Prolunga MA Rod Coupling AM		
Lunghezza / Length			1000			
						
Finitura / Finishing	ZE	ZE	ZE	IX	ZE	IX
M 6	—	2610505	2020301	2420301	2020351	2420351
M 8	—	2610504	2020302	2420302	2020352	2420352
M 10	2610501	2610508	2020303	2420303	2020353	2420353
M 12	—	2610509	2020304	2420304	2020354	2420354

GUIDA ALLA SCELTA / GUIDE FOR CHOOSING

Viterie / Screws		Giunzioni elettriche coperchi Electrical connection covers.		Giunzioni elettriche basi Electrical connection bottoms.		Vite e dado Screw and nut	Vite con quadro sottotesta Screw with short square section		Testa esagonale Hex head screw			Testa cilindrica Socket head screw
Finitura / Finishing		BZE	IX	BZE	IX	BZF	BZE	IX	BZE	BZF	IX	IX
M 5	x 5	2710003	2730003									
	x 8			2710002	2730002							
M 6	x 10						2710001	2730001				
	x 15					2720551						
M 8	x 20						2710151		2710251	2720101	2730251	2730351
	x 30						2710152		2710252	2720102	2730252	2730353
	x 50								2710254	2720254	2730254	
	x 60								2710253	2720253	2730153	
M 10	x 20						2710201		2710301	2720151	2730301	
	x 30						2710202		2710302	2720152	2730302	
	x 50								2710303	2720153	2730303	

Viterie / Screws		Testa ad ancora con dado e rondella Anchor head screw with nut and washer		Testa ad ancora con dado con flangia zigrinata Anchor head screw with hex flange nut serrated	
Finitura / Finishing		BZE		GEOMET	
M 10	x 30	2710351		2720351	

Accessori / Accessories		Piastrina ad ancora per profilo PRP Channel nut with long spring for PRP "U" section		Piastrina ad ancora molla lunga per profilo PRM Channel nut with long spring for PRM "U" section			Piastrina ad ancora molla lunga per profilo PRL Channel nut with long spring for PRL "U" section			Piastrina ad ancora Channel nut without spring	
Finitura / Finishing		BZE	DRACOMET	BZE	BZF	IX	BZE	BZF	IX	BZE	BZF
M 6				2710669	2710670	2730657	2710656	2720656	2730656		
M 8		2710601	2710611	2710661	2710665	2730665	2710663	2710667	2730667	2720660	2730660
M 10		2710602	2710612	2710662	2710666	2730666	2710664	2710668	2730668		

Accessori / Accessories		Dado esagonale Hex nut			Dado flangia zigrinata Hexagon flange nut serrated			Rondelle piane Washers flats			Rondelle grower Washers locks			Rondelle dentellate Washers external teeth.	
Finitura / Finishing		BZE	BZF	IX	BZE	BZF	IX	BZE	BZF	IX	BZE	BZF	IX	BZE	IX
M 6		2710552	2720300	2730552	2710501	2720505	2730055	2710801	2720400	2730101	2710851	2720450	2730450	2710901	2730901
M 8		2710553	2720301	2730553	2710502	2720502	2730054	2710802	2720404	2720401	2710852	2720451	2730451	2710902	2730501
M 10		2710554	2720302	2730554	2710503	2720503	2730503	2710803	2720402	2730103	2710853	2720452	2730452	2710903	2730902
M 12		2710555	2720303	2730555	2710504	2720504	2730504	2710804	2720403	2730104	2710854	2720904	2730453	2710905	2730905

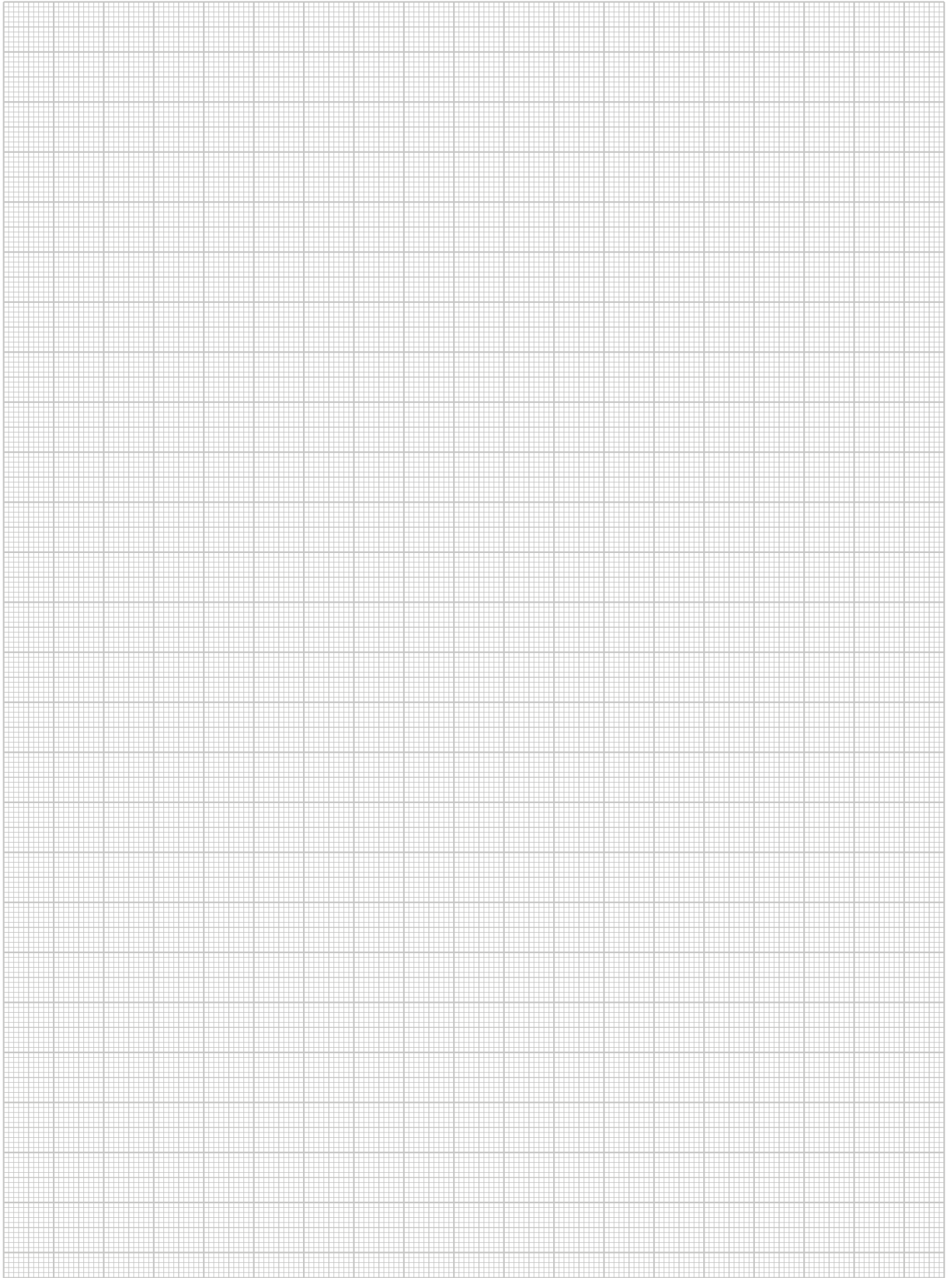



Via Ferrero, 7c - 10098 Rivoli (TO) Italy
Tel. +39 011.95.90.111
Fax Comm.: +39 011.95.90.200
Fax Amm.: +39 011.95.90.230
info.sati@sati.it



9130018 -

